

SHINVA 新华医疗

# 胸腔镜小切口器械

THORACOSCOPIC SMALL  
INCISION INSTRUMENTS



新华手术器械有限公司  
XINHUA SURGICAL INSTRUMENT CO.,LTD.

# 公司简介 Company Profile



1943年新华医疗诞生于胶东抗日根据地，是我党我军早期创建的医疗器械生产企业，手术器械是新华医疗的起家产品，经过八十余年匠心传承，现已发展为国内手术器械行业领军企业。

新华手术器械有限公司专业从事手术器械的研发、生产和销售，引进国际先进的手术器械制造工艺和装备，拥有一流的手术器械生产线。公司产品涵盖了神经外科、骨科、普外科、心胸外科等临床外科各科室，拥有14000余个品种规格。公司积极布局微创外科领域，先后推出腔镜器械、内窥镜摄像系统、光学硬镜、微创手术设备及耗材等产品，已打造成集手术器械、手术设备、手术耗材、硬质容器四大系列的产品矩阵，满足外科手术“器械+设备+耗材”整体配置需要。

公司通过ISO9001质量体系认证和ISO13485医疗器械质量体系认证，主持和参与起草多项行业标准，产品获得欧盟CE认证和美国FDA认证，远销亚洲、中东、欧美的60多个国家和地区。

公司为国家专精特新“小巨人”企业、山东省制造业单项冠军企业，拥有省级企业技术中心、省级“一企一技术”研发中心等技术创新平台，产品制造工艺技术和质量控制水平位居国内前列，表面处理、防腐耐蚀等方面技术能力处于国际先进水平。

我们始终奉行“质量—我们迈向成功之路”的品牌理念，持续走医工结合的创新之路，为各级医疗机构和临床专家提供专业化的解决方案，以满足国内外外科手术快速发展的需要，为人类健康事业做出更大贡献。



Shinva Medical is the medical device manufacturer set up by our Party and military in 1943 with surgical instruments as the starting product. Now as surgical instrument subsidiary of Shinva Medical, Xinhua Surgical Instrument Co., Ltd. , has developed into a leading company in the domestic surgical instrument industry after more than 80 years of production experience.

Specializing in R&D, production and sales of surgical instruments, Xinhua Surgical Instrument Co., Ltd. has first-class production line for surgical instruments with advanced imported manufacturing techniques and machines. Product portfolio covers various clinical departments such as neuro, orthopedics, cardiothoracic and general surgeries etc with over 14,000 varieties and specifications. The company has actively developed minimally invasive surgery items and launched product lines including endoscopic instruments, endoscopic camera systems, endoscopes, and MIS equipment and consumables. Now with four product families: surgical instruments, surgical equipment, surgical consumables, and sterilization containers, the company can meet the overall clinical needs of "instruments + equipment + consumables".

The company has obtained ISO9001 and ISO13485 certificates, organized and participated drafting some industrial standards. Products are certified CE MDR, registered in USFDA and exported to over 60 countries in Asia, the Middle East, Europe and America etc.

The company is rewarded “national-level Specialized and Sophisticated Little Giant Enterprise”, “single champion enterprise in Shandong Province's manufacturing industry”, and has “provincial-level technology center” and “provincial-level one-enterprise-one-technology technology center” and other technical innovation centers. Its manufacturing techniques and quality control are in the top of China, its surface treatment, and corrosion resistance technique are at the international advanced level.

Following our principle”Quality - our way to success” all the time and on the way of continuous innovation with clinic support, the company is devoted to supply professional clinical solutions to meet rapid development needs of hospitals and surgeons and devoted greater contribution in the health of human being.



# 目录

## CONTENT

精细剪 / Delicate scissors .....	01
小切口持针钳 / Small incision needle holder .....	01
夹持钳 / Grasping forceps .....	02
分离结扎钳 / Dissecting and ligature forceps .....	02
单孔型·血管钳 / Uniportal Vascular clamp,single action .....	03
分离结扎钳 / Dissecting and ligature forceps .....	10
单孔型·海绵钳 / Uniportal Sponge forceps,single action .....	12
海绵钳 / Sponge forceps .....	14
单孔型·海绵钳/ Uniportal Sponge forceps,single action .....	18
单孔型·小切口持针钳 / Uniportal needle holder with TC 0.3 for thin needle,single action .....	19
单孔型·精细剪 / Uniportal delicate scissors, single action .....	21
单孔型·夹持钳 / Uniporta holding forceps, Shaft 5mm,single action .....	22
小切口肺叶钳 / MIS lung grasping forceps .....	23
小切口组织钳 / MIS tissue forceps .....	24
小切口淋巴钳 / MIS lymphatic forceps .....	25
小切口组织钳 / MIS tissue forceps .....	26
单孔型·器械钳 / Clip applying forceps,single action (不包含止血夹) .....	26
血管钳 / Vascular clamp .....	27
分离结扎钳 / Dissecting and ligature forceps .....	28
海绵钳 / Sponge forceps .....	28
精细剪 / Delicate scissors .....	29
小切口组织钳 / MIS tissue forceps .....	30
手术刀柄 / Scalpel handle .....	31
剥离器 / Mediastinal retractor .....	31
小切口手术缝合线拉钩 / MMIS suture hook .....	32
吸引管 / Suction tube .....	32
外科牵开器 / Surgical retractor .....	34
胸腔外科手术器械包(微创搭桥包) (ZL181) MIS Heart Bypass Instruments Set .....	37
胸腔外科手术器械包(微创瓣膜包) (ZL182) MIS Valve Replacement Instruments Set .....	38
微创小切口双关节器械包(ZP1579) MIS Incision Double Joint Instrument Set .....	39
微创小切口双关节器械包(ZP1608) MIS Incision Double Joint Instrument Set .....	40
微创小切口双关节器械包(ZP1609) MIS Incision Double Joint Instrument Set .....	41
微创小切口双关节器械包(ZP1610) MIS Incision Double Joint Instrument Set .....	42

## 精细剪 / Delicate scissors

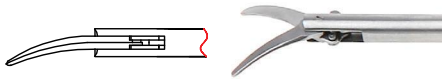
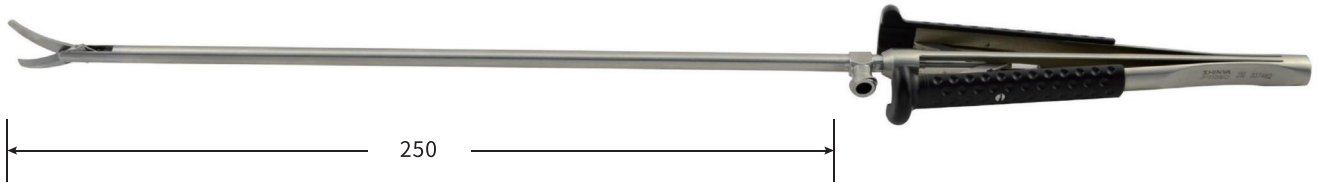

★ **JP1610RB**  
250, 弯, 双开, 握笔管式  
Double action



★ **JP1613RB**  
250, 弯, 双开, 握笔管式  
Double action



★ **JP1622RB**  
250, 弯45°, 单开, 握笔管式  
Single action



★ **JP1625RB**  
250, 弯90°, 单开, 握笔管式  
Single action



★ **JP1628RB**  
250, 弯125°, 单开, 握笔管式  
Single action

## 小切口持针钳 / Small incision needle holder

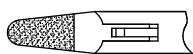

★ **JP1658RB**  
250, 直, 单开, 握笔管式  
Single action,  
with diamond dust

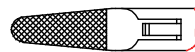

★ **JP1643RB**  
250, 直, 单开, 镶片, 握笔管式  
Single action,TC



★ **JP1646RB**  
250, 弯, 单开, 镶片, 握笔管式  
Single action,TC

夹持钳 / Grasping forceps

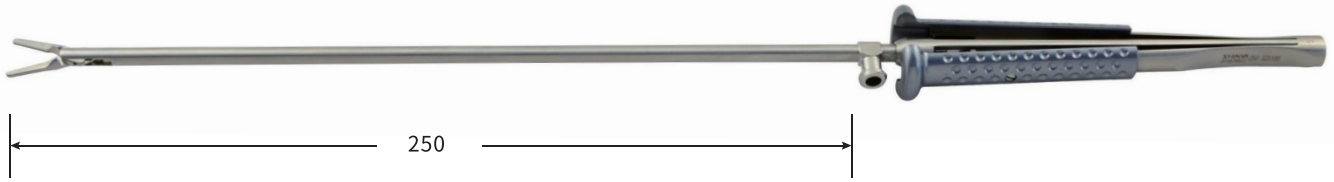

★ **JP1667RB**  
 250×1.5, 1×2凹凸齿,  
 直头, 双开, 握笔管式  
 Double action, atraumatic



★ **JP1670RB**  
 250×1.5, 1×2凹凸齿,  
 上翘45°, 握笔管式  
 Single action, atraumatic



★ **JP1685RB**  
 250×1.5, 1×2凹凸齿,  
 角弯, 单开, 握笔管式  
 Single action, atraumatic



★ **JP1691RB**  
 250, 上翘45°, 单开, 握笔管式  
 Single action



★ **JP1694RB**  
 250, 直型, 握笔管式  
 Double action



★ **JP1676RB**  
 250×3, 直头, 单开,  
 握笔管式  
 Single action



★ **JP1673RB**  
 250×2.8, 1×2凹凸齿,  
 直头, 双开, 握笔管式  
 Double action, atraumatic



★ **JP1703RB**  
 250, 握笔管式  
 Titanium clip applier, small



★ **JP1706RB**  
 250, 握笔管式  
 Titanium clip applier, medium

分离结扎钳 / Dissecting and ligature forceps



★ **JP1700RB**  
 250, 弯, 双开,  
 握笔管式  
 Double action

单孔型·血管钳(常规头3mm,精细头2mm) / Uniportal Vascular clamp, single action (normal tip 3mm, fine tip 2mm)

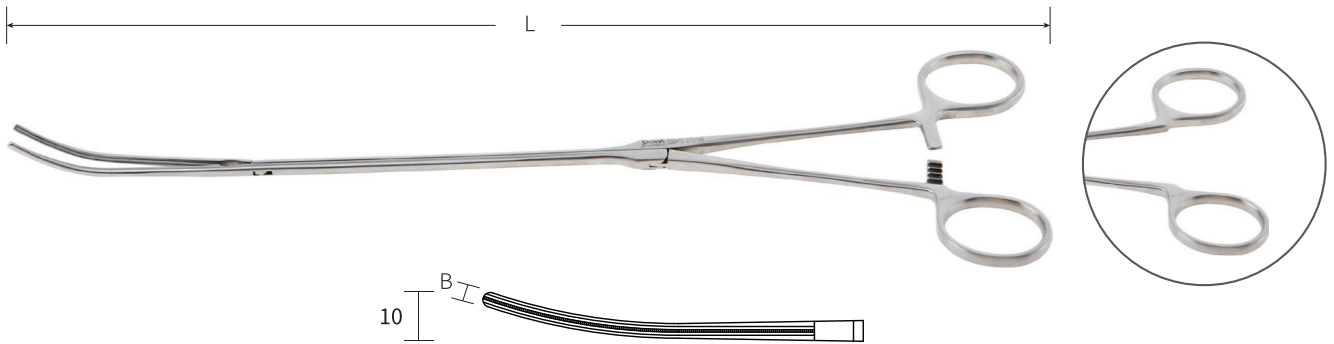

编码 article no.	L(总长) (total length)	杆径 shaft dia.	弯高 curve height	B(头宽) (tip width)	齿形 atraumatic teeth	是否带锁止牙 with ratchet
ZP1720RB	360	6	10	3	1×2齿 teeth	是 yes
ZP1719RB	360	6	10	2	1×2齿 teeth	是 yes
ZP1592RB	420	6	10	2	1×2齿 teeth	是 yes

编码 article no.	L(总长) (total length)	杆径 shaft dia.	弯高 curve height	B(头宽) (tip width)	齿形 atraumatic teeth	是否带锁止牙 with ratchet
DP1720RB	360	6	10	3	1×2齿 teeth	是 yes
DP1719RB	360	6	10	2	1×2齿 teeth	是 yes
DP1592RB	420	6	10	2	1×2齿 teeth	是 yes



编码 article no.	L(总长) (total length)	杆径 shaft dia.	弯高 curve height	B(头宽) (tip width)	齿形 atraumatic teeth	是否带锁止牙 with ratchet
ZP1500RB	330	5.5	15	3	1×2齿 teeth	是 yes
ZP1501RB	330	5.5	15	3	1×2齿 teeth	否 no
ZP1567RB	360	6	15	3	1×2齿 teeth	是 yes
ZP1712RB	360	6	15	2	1×2齿 teeth	是 yes
ZP1593RB	420	6	15	2	1×2齿 teeth	是 yes

编码 article no.	L(总长) (total length)	杆径 shaft dia.	弯高 curve height	B(头宽) (tip width)	齿形 atraumatic teeth	是否带锁止牙 with ratchet
DP1500RB	330	5.5	15	3	1×2齿 teeth	是 yes
DP1501RB	330	5.5	15	3	1×2齿 teeth	否 no
DP1567RB	360	6	15	3	1×2齿 teeth	是 yes
DP1712RB	360	6	15	2	1×2齿 teeth	是 yes
DP1593RB	420	6	15	2	1×2齿 teeth	是 yes

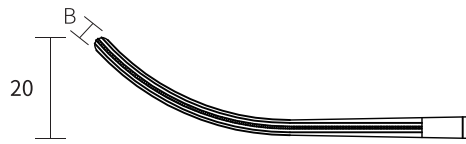

编码 article no.	L (总长) (total length)	杆径 shaft dia.	弯高 curve height	B (头宽) (tip width)	齿形 atraumatic teeth	是否带锁止牙 with ratchet
ZP1502RB	330	5.5	20	3	1×2齿 teeth	是 yes
ZP1503RB	330	5.5	20	3	1×2齿 teeth	否 no
ZP1568RB	360	6	20	3	1×2齿 teeth	是 yes
ZP1713RB	360	6	20	2	1×2齿 teeth	是 yes
ZP1594RB	420	6	20	2	1×2齿 teeth	是 yes

编码 article no.	L (总长) (total length)	杆径 shaft dia.	弯高 curve height	B (头宽) (tip width)	齿形 atraumatic teeth	是否带锁止牙 with ratchet
DP1502RB	330	5.5	20	3	1×2齿 teeth	是 yes
DP1503RB	330	5.5	20	3	1×2齿 teeth	否 no
DP1568RB	360	6	20	3	1×2齿 teeth	是 yes
DP1713RB	360	6	20	2	1×2齿 teeth	是 yes
DP1594RB	420	6	20	2	1×2齿 teeth	是 yes



编码 article no.	L (总长) (total length)	杆径 shaft dia.	弯高 curve height	B (头宽) (tip width)	齿形 atraumatic teeth	是否带锁止牙 with ratchet
ZP1504RB	330	5.5	25	3	1×2齿 teeth	是 yes
ZP1505RB	330	5.5	25	3	1×2齿 teeth	否 no
ZP1569RB	360	6	25	3	1×2齿 teeth	是 yes
ZP1714RB	360	6	25	2	1×2齿 teeth	是 yes
ZP1595RB	420	6	25	2	1×2齿 teeth	是 yes

编码 article no.	L (总长) (total length)	杆径 shaft dia.	弯高 curve height	B (头宽) (tip width)	齿形 atraumatic teeth	是否带锁止牙 with ratchet
DP1504RB	330	5.5	25	3	1×2齿 teeth	是 yes
DP1505RB	330	5.5	25	3	1×2齿 teeth	否 no
DP1569RB	360	6	25	3	1×2齿 teeth	是 yes
DP1714RB	360	6	25	2	1×2齿 teeth	是 yes
DP1595RB	420	6	25	2	1×2齿 teeth	是 yes

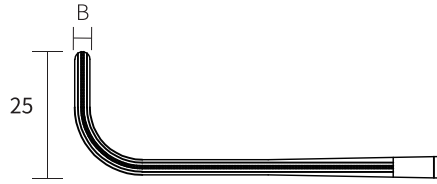

编码 article no.	L(总长) (total length)	杆径 shaft dia.	弯高 curve height	B(头宽) (tip width)	齿形 atraumatic teeth	是否带锁止牙 with ratchet
ZP1506RB	330	5.5	25	3	1×2齿 teeth	是 yes
ZP1507RB	330	5.5	25	3	1×2齿 teeth	否 no
ZP1570RB	360	6	25	3	1×2齿 teeth	是 yes
ZP1715RB	360	6	25	2	1×2齿 teeth	是 yes
ZP1596RB	420	6	25	2	1×2齿 teeth	是 yes

编码 article no.	L(总长) (total length)	杆径 shaft dia.	弯高 curve height	B(头宽) (tip width)	齿形 atraumatic teeth	是否带锁止牙 with ratchet
DP1506RB	330	5.5	25	3	1×2齿 teeth	是 yes
DP1507RB	330	5.5	25	3	1×2齿 teeth	否 no
DP1570RB	360	6	25	3	1×2齿 teeth	是 yes
DP1715RB	360	6	25	2	1×2齿 teeth	是 yes
DP1596RB	420	6	25	2	1×2齿 teeth	是 yes



编码 article no.	L(总长) (total length)	杆径 shaft dia.	H(弯高) (curve height)	B(头宽) (tip width)	齿形 atraumatic teeth	是否带锁止牙 with ratchet
ZP1555RB	330	5.5	18	3	1×2齿 teeth	是 yes
ZP1556RB	330	5.5	18	3	1×2齿 teeth	否 no
ZP1571RB	360	6	18	3	1×2齿 teeth	是 yes
ZP1716RB	360	6	18	2	1×2齿 teeth	是 yes
ZP1591RB	420	6	20	2	1×2齿 teeth	是 yes

编码 article no.	L(总长) (total length)	杆径 shaft dia.	H(弯高) (curve height)	B(头宽) (tip width)	齿形 atraumatic teeth	是否带锁止牙 with ratchet
DP1555RB	330	5.5	18	3	1×2齿 teeth	是 yes
DP1556RB	330	5.5	18	3	1×2齿 teeth	否 no
DP1571RB	360	6	18	3	1×2齿 teeth	是 yes
DP1716RB	360	6	18	2	1×2齿 teeth	是 yes
DP1591RB	420	6	20	2	1×2齿 teeth	是 yes

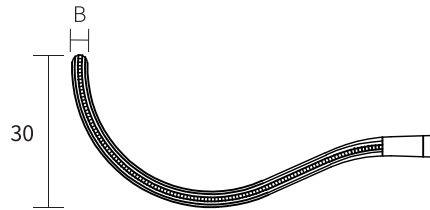

编码 article no.	L (总长) (total length)	杆径 shaft dia.	弯高 curve height	B (头宽) (tip width)	齿形 atraumatic teeth	是否带锁止牙 with ratchet
ZP1508RB	330	5.5	30	3	1×2齿 teeth	是 yes
ZP1509RB	330	5.5	30	3	1×2齿 teeth	否 no
ZP1572RB	360	6	30	3	1×2齿 teeth	是 yes
ZP1600RB	420	6	30	2	1×2齿 teeth	是 yes

编码 article no.	L (总长) (total length)	杆径 shaft dia.	弯高 curve height	B (头宽) (tip width)	齿形 atraumatic teeth	是否带锁止牙 with ratchet
DP1508RB	330	5.5	30	3	1×2齿 teeth	是 yes
DP1509RB	330	5.5	30	3	1×2齿 teeth	否 no
DP1572RB	360	6	30	3	1×2齿 teeth	是 yes
DP1600RB	420	6	30	2	1×2齿 teeth	是 yes



编码 article no.	L (总长) (total length)	杆径 shaft dia.	弯高 curve height	B (头宽) (tip width)	齿形 atraumatic teeth	是否带锁止牙 with ratchet
ZP1581RB	360	6	15	3	1×2齿 teeth	是 yes
ZP1717RB	360	6	15	2	1×2齿 teeth	是 yes

编码 article no.	L (总长) (total length)	杆径 shaft dia.	弯高 curve height	B (头宽) (tip width)	齿形 atraumatic teeth	是否带锁止牙 with ratchet
DP1581RB	360	6	15	3	1×2齿 teeth	是 yes
DP1717RB	360	6	15	2	1×2齿 teeth	是 yes



编码 article no.	L (总长) (total length)	杆径 shaft dia.	弯高 curve height	B (头宽) (tip width)	齿形 atraumatic teeth	是否带锁止牙 with ratchet
ZP1585RB	360	6	15	3	1×2齿 teeth	是 yes
ZP1718RB	360	6	15	2	1×2齿 teeth	是 yes

编码 article no.	L (总长) (total length)	杆径 shaft dia.	弯高 curve height	B (头宽) (tip width)	齿形 atraumatic teeth	是否带锁止牙 with ratchet
DP1585RB	360	6	15	3	1×2齿 teeth	是 yes
DP1718RB	360	6	15	2	1×2齿 teeth	是 yes

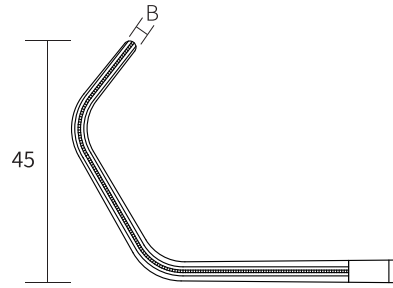

编码 article no.	L (总长) (total length)	杆径 shaft dia.	弯高 curve height	B (头宽) (tip width)	齿形 atraumatic teeth	是否带锁止牙 with ratchet
ZP1601RB	350	6	45	2.5	1×2齿 teeth	是 yes

编码 article no.	L (总长) (total length)	杆径 shaft dia.	弯高 curve height	B (头宽) (tip width)	齿形 atraumatic teeth	是否带锁止牙 with ratchet
DP1601RB	350	6	45	2.5	1×2齿 teeth	是 yes

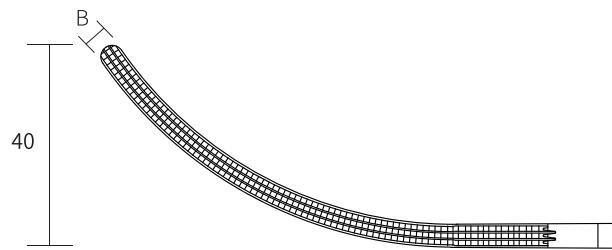

编码 article no.	L (总长) (total length)	杆径 shaft dia.	弯高 curve height	B (头宽) (tip width)	齿形 atraumatic teeth	是否带锁止牙 with ratchet
ZP1580RB	360	8	40	4.5	2×3齿 teeth	是 yes

编码 article no.	L (总长) (total length)	杆径 shaft dia.	弯高 curve height	B (头宽) (tip width)	齿形 atraumatic teeth	是否带锁止牙 with ratchet
DP1580RB	360	8	40	4.5	2×3齿 teeth	是 yes

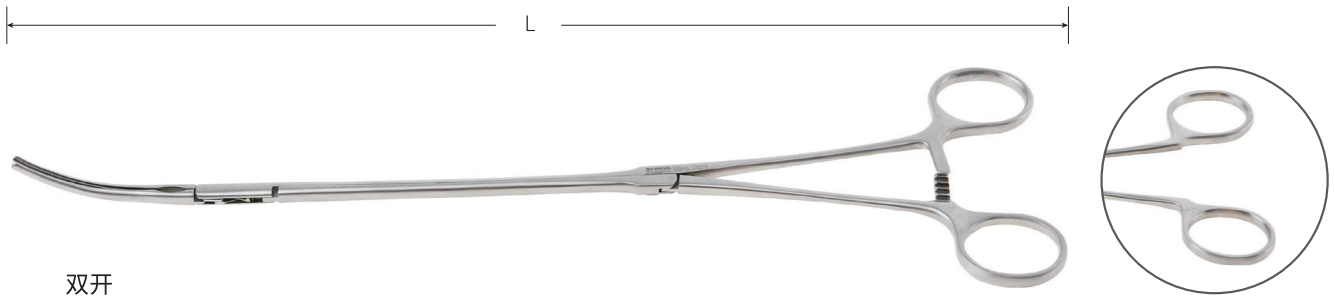

双开  
double action

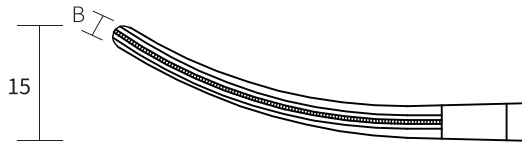

编码 article no.	L(总长) (total length)	杆径 shaft dia.	弯高 curve height	B(头宽) (tip width)	齿形 atraumatic teeth	是否带锁止牙 with ratchet	头部打开形式 tip opening
ZP1526RB	330	6	15	3	1×2齿 teeth	是 yes	双开 double action
ZP1527RB	330	6	15	3	1×2齿 teeth	否 no	双开 double action

编码 article no.	L(总长) (total length)	杆径 shaft dia.	弯高 curve height	B(头宽) (tip width)	齿形 atraumatic teeth	是否带锁止牙 with ratchet	头部打开形式 tip opening
DP1526RB	330	6	15	3	1×2齿 teeth	是 yes	双开 double action
DP1527RB	330	6	15	3	1×2齿 teeth	否 no	双开 double action

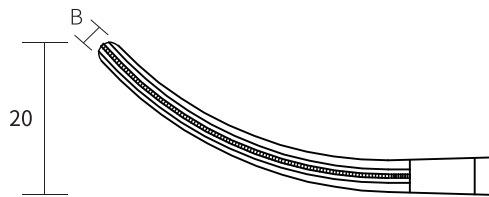

编码 article no.	L(总长) (total length)	杆径 shaft dia.	弯高 curve height	B(头宽) (tip width)	齿形 atraumatic teeth	是否带锁止牙 with ratchet	头部打开形式 tip opening
ZP1528RB	330	6	20	3	1×2齿 teeth	是 yes	双开 double action
ZP1529RB	330	6	20	3	1×2齿 teeth	否 no	双开 double action

编码 article no.	L(总长) (total length)	杆径 shaft dia.	弯高 curve height	B(头宽) (tip width)	齿形 atraumatic teeth	是否带锁止牙 with ratchet	头部打开形式 tip opening
DP1528RB	330	6	20	3	1×2齿 teeth	是 yes	双开 double action
DP1529RB	330	6	20	3	1×2齿 teeth	否 no	双开 double action

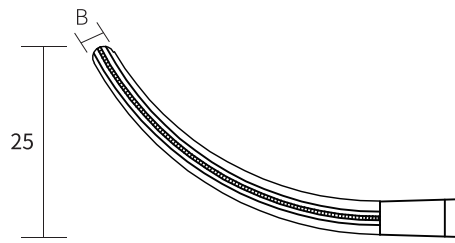

编码 article no.	L (总长) (total length)	杆径 shaft dia.	弯高 curve height	B (头宽) (tip width)	齿形 atraumatic teeth	是否带锁止牙 with ratchet	头部打开形式 tip opening
ZP1530RB	330	6	25	3	1×2齿 teeth	是 yes	双开 double action
ZP1531RB	330	6	25	3	1×2齿 teeth	否 no	双开 double action

编码 article no.	L (总长) (total length)	杆径 shaft dia.	弯高 curve height	B (头宽) (tip width)	齿形 atraumatic teeth	是否带锁止牙 with ratchet	头部打开形式 tip opening
DP1530RB	330	6	25	3	1×2齿 teeth	是 yes	双开 double action
DP1531RB	330	6	25	3	1×2齿 teeth	否 no	双开 double action

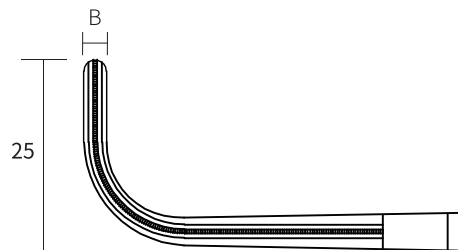

编码 article no.	L (总长) (total length)	杆径 shaft dia.	弯高 curve height	B (头宽) (tip width)	齿形 atraumatic teeth	是否带锁止牙 with ratchet	头部打开形式 tip opening
ZP1532RB	330	6	25	3	1×2齿 teeth	是 yes	双开 double action
ZP1533RB	330	6	25	3	1×2齿 teeth	否 no	双开 double action

编码 article no.	L (总长) (total length)	杆径 shaft dia.	弯高 curve height	B (头宽) (tip width)	齿形 atraumatic teeth	是否带锁止牙 with ratchet	头部打开形式 tip opening
DP1532RB	330	6	25	3	1×2齿 teeth	是 yes	双开 double action
DP1533RB	330	6	25	3	1×2齿 teeth	否 no	双开 double action

分离结扎钳 / Dissecting and ligature forceps

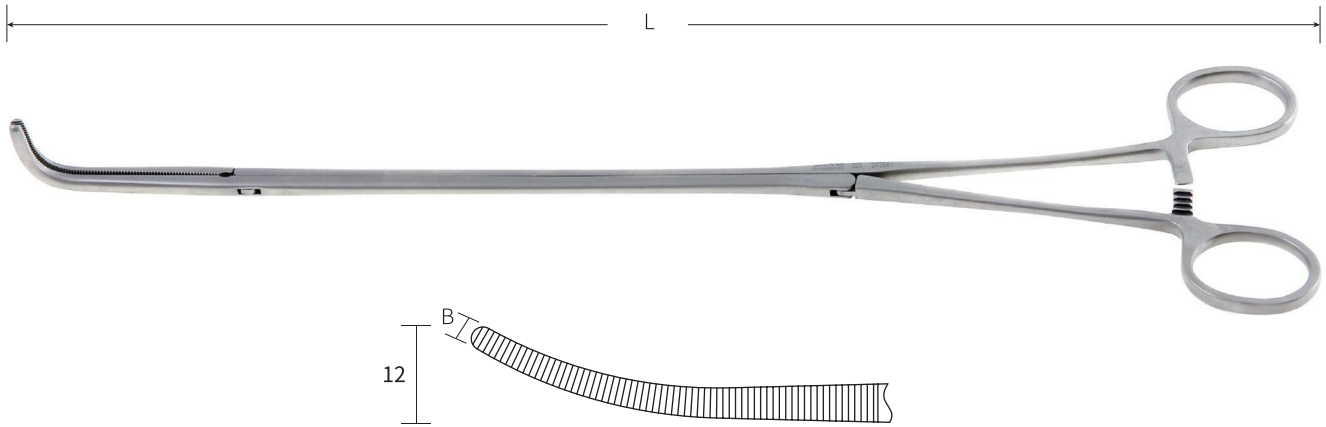

编码 article no.	L(总长) (total length)	杆径 shaft dia.	弯高 curve height	B(头宽) (tip width)	齿形 jaw teeth	是否带锁止牙 with ratchet
ZP1582RB	360	6	12	2.8	横齿 serrated	是 yes

编码 article no.	L(总长) (total length)	杆径 shaft dia.	弯高 curve height	B(头宽) (tip width)	齿形 jaw teeth	是否带锁止牙 with ratchet
DP1582RB	360	6	12	2.8	横齿 serrated	是 yes

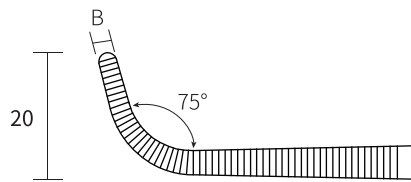

编码 article no.	L(总长) (total length)	杆径 shaft dia.	弯高 curve height	B(头宽) (tip width)	齿形 jaw teeth	是否带锁止牙 with ratchet
ZP1583RB	360	6	20	2.8	横齿 serrated	是 yes

编码 article no.	L(总长) (total length)	杆径 shaft dia.	弯高 curve height	B(头宽) (tip width)	齿形 jaw teeth	是否带锁止牙 with ratchet
DP1583RB	360	6	20	2.8	横齿 serrated	是 yes

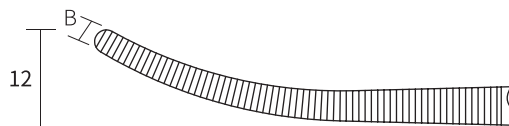

编码 article no.	L(总长) (total length)	杆径 shaft dia.	弯高 curve height	B(头宽) (tip width)	齿形 jaw teeth	是否带锁止牙 with ratchet
ZP1188RB	340	8	12	3	横齿 serrated	是 yes

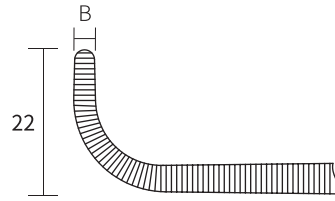

编码 article no.	L(总长) (total length)	杆径 shaft dia.	弯高 curve height	B(头宽) (tip width)	齿形 jaw teeth	是否带锁止牙 with ratchet
ZP1189RB	340	8	22	3	横齿 serrated	是 yes

### 分离结扎钳 / Dissecting and ligature forceps

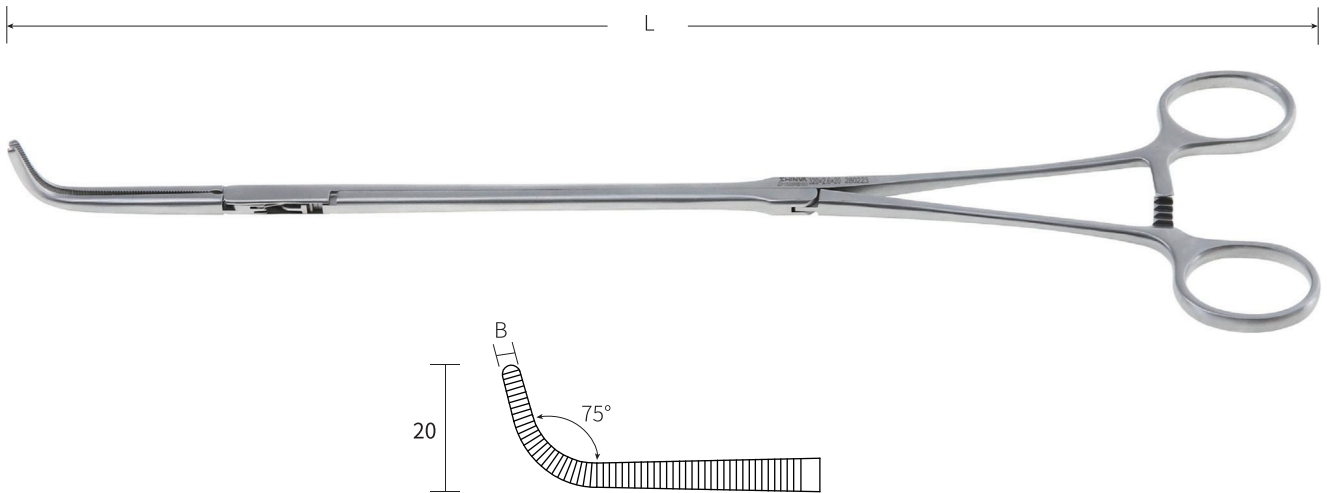

编码 article no.	L(总长) (total length)	杆径 shaft dia.	弯高 curve height	B(头宽) (tip width)	齿形 jaw teeth	是否带锁止牙 with ratchet
ZP1535RB	320	8	20	2.8	横齿 serrated	是 yes

编码 article no.	L(总长) (total length)	杆径 shaft dia.	弯高 curve height	B(头宽) (tip width)	齿形 jaw teeth	是否带锁止牙 with ratchet
DP1535RB	320	8	20	2.8	横齿 serrated	是 yes

单孔型·海绵钳 / Uniportal Sponge forceps, single action

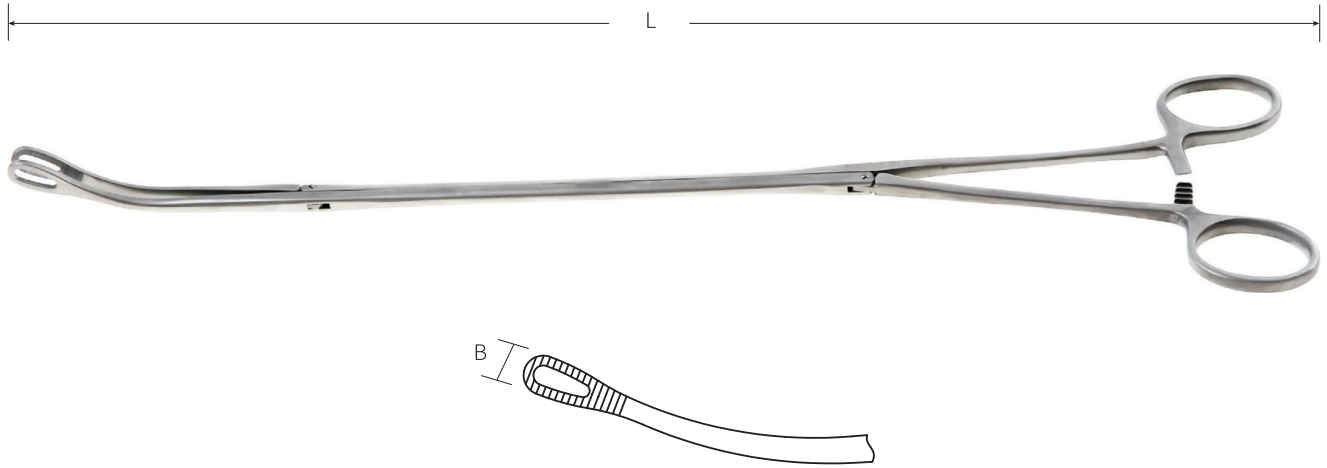

编码 article no.	L(总长) (total length)	杆径 shaft dia.	B(头宽) (tip width)	齿形 jaw teeth	是否带锁止牙 with ratchet
ZP1548RB	340	5.5	8	横齿 serrated	是 yes
ZP1549RB	340	5.5	10	横齿 serrated	是 yes
ZP1550RB	340	5.5	12	横齿 serrated	是 yes
ZP1605RB	360	6	8	横齿 serrated	是 yes
ZP1606RB	360	6	10	横齿 serrated	是 yes
ZP1607RB	360	6	12	横齿 serrated	是 yes

编码 article no.	L(总长) (total length)	杆径 shaft dia.	B(头宽) (tip width)	齿形 jaw teeth	是否带锁止牙 with ratchet
DP1548RB	340	5.5	8	横齿 serrated	是 yes
DP1549RB	340	5.5	10	横齿 serrated	是 yes
DP1550RB	340	5.5	12	横齿 serrated	是 yes
DP1605RB	360	6	8	横齿 serrated	是 yes
DP1606RB	360	6	10	横齿 serrated	是 yes
DP1607RB	360	6	12	横齿 serrated	是 yes

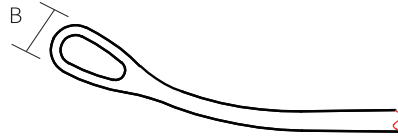

编码 article no.	L (总长) (total length)	杆径 shaft dia.	B (头宽) (tip width)	齿形 jaw teeth	是否带锁止牙 with ratchet
ZP1557RB	340	5.5	8	无齿 smooth	是 yes
ZP1558RB	340	5.5	10	无齿 smooth	是 yes
ZP1559RB	340	5.5	12	无齿 smooth	是 yes
ZP1602RB	360	6	8	无齿 smooth	是 yes
ZP1603RB	360	6	10	无齿 smooth	是 yes
ZP1604RB	360	6	12	无齿 smooth	是 yes

编码 article no.	L (总长) (total length)	杆径 shaft dia.	B (头宽) (tip width)	齿形 jaw teeth	是否带锁止牙 with ratchet
DP1557RB	340	5.5	8	无齿 smooth	是 yes
DP1558RB	340	5.5	10	无齿 smooth	是 yes
DP1559RB	340	5.5	12	无齿 smooth	是 yes
DP1602RB	360	6	8	无齿 smooth	是 yes
DP1603RB	360	6	10	无齿 smooth	是 yes
DP1604RB	360	6	12	无齿 smooth	是 yes



编码 article no.	L (总长) (total length)	杆径 shaft dia.	B (头宽) (tip width)	齿形 jaw teeth	是否带锁止牙 with ratchet
ZP1587RB	340	5.5	12	无齿 smooth	是 yes

编码 article no.	L (总长) (total length)	杆径 shaft dia.	B (头宽) (tip width)	齿形 jaw teeth	是否带锁止牙 with ratchet
DP1587RB	340	5.5	12	无齿 smooth	是 yes



编码 article no.	L (总长) (total length)	杆径 shaft dia.	B (头宽) (tip width)	齿形 jaw teeth	是否带锁止牙 with ratchet
ZP1588RB	340	5.5	12	无齿 smooth	是 yes

编码 article no.	L (总长) (total length)	杆径 shaft dia.	B (头宽) (tip width)	齿形 jaw teeth	是否带锁止牙 with ratchet
DP1588RB	340	5.5	12	无齿 smooth	是 yes

海绵钳 / Sponge forceps

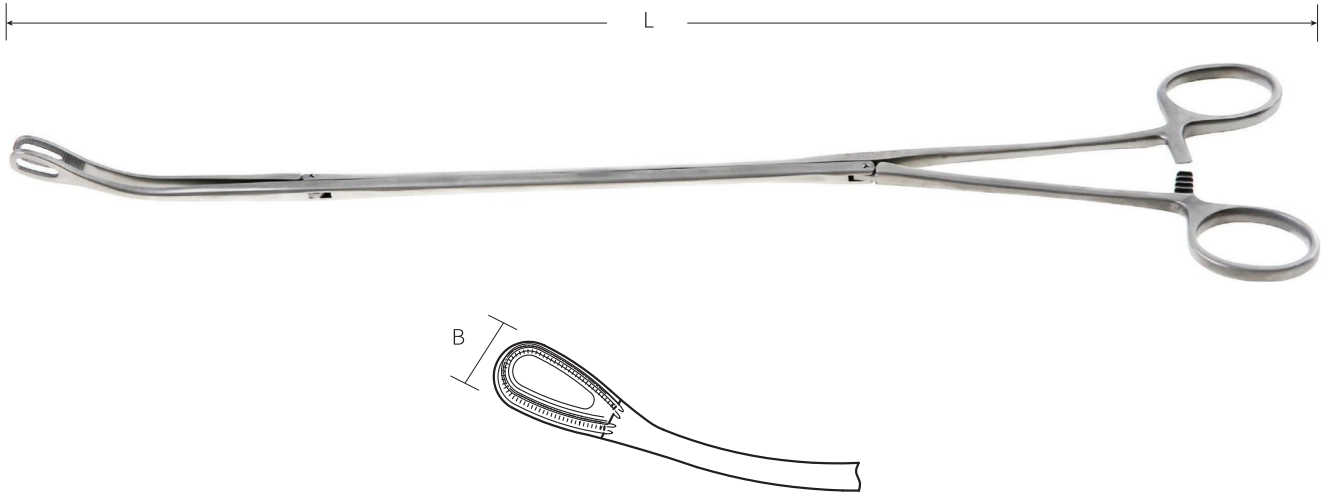

编码 article no.	L(总长) (total length)	杆径 shaft dia.	B(头宽) (tip width)	齿形 atraumatic teeth	是否带锁止牙 with ratchet
ZP1217RB	360	8	8	1×2齿 teeth	是 yes
ZP1218RB	360	8	10	1×2齿 teeth	是 yes
ZP1221RB	360	8	12	1×2齿 teeth	是 yes

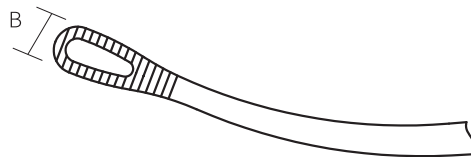

编码 article no.	L(总长) (total length)	杆径 shaft dia.	B(头宽) (tip width)	齿形 jaw teeth	是否带锁止牙 with ratchet
ZP1173RB	360	8	8	横齿 serrated	是 yes
ZP1172RB	360	8	10	横齿 serrated	是 yes
ZP1171RB	360	8	12	横齿 serrated	是 yes
ZP1560RB	420	6.5	10	横齿 serrated	是 yes

编码 article no.	L(总长) (total length)	杆径 shaft dia.	B(头宽) (tip width)	齿形 jaw teeth	是否带锁止牙 with ratchet
DP1560RB	420	6.5	10	横齿 serrated	是 yes

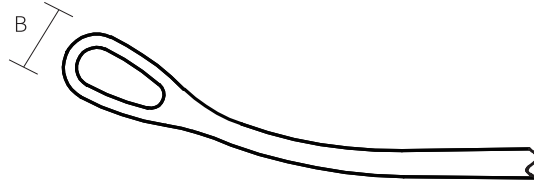

编码 article no.	L(总长) (total length)	杆径 shaft dia.	B(头宽) (tip width)	齿形 jaw teeth	是否带锁止牙 with ratchet
ZP1561RB	420	6.5	10	无齿 smooth	是 yes

编码 article no.	L(总长) (total length)	杆径 shaft dia.	B(头宽) (tip width)	齿形 jaw teeth	是否带锁止牙 with ratchet
DP1561RB	420	6.5	10	无齿 smooth	是 yes

单孔型·海绵钳 / Uniportal Sponge forceps, single action

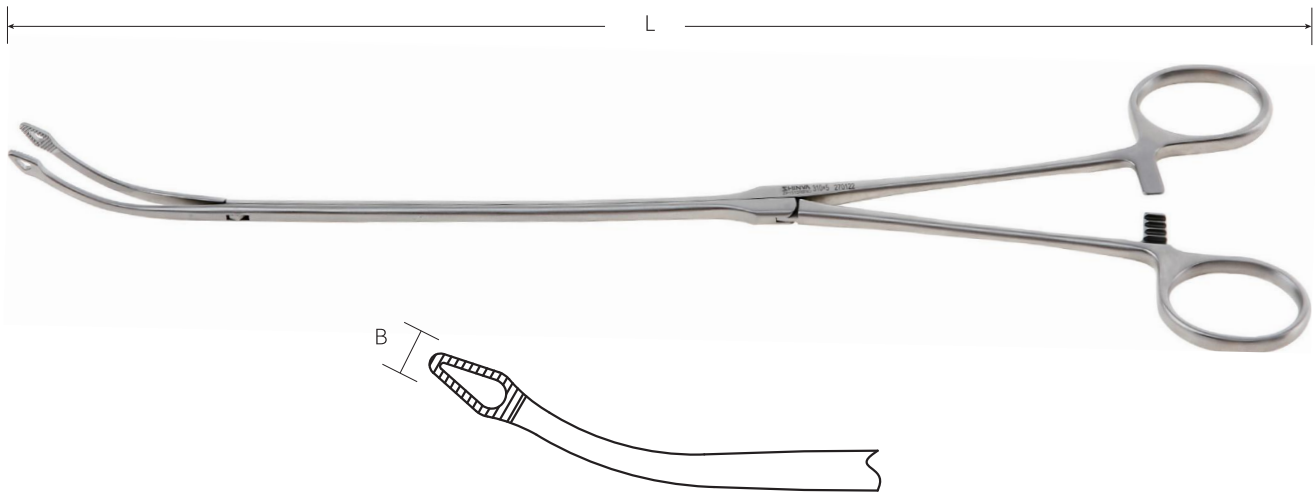

编码 article no.	L(总长) (total length)	杆径 shaft dia.	B(头宽) (tip width)	齿形 jaw teeth	是否带锁止牙 with ratchet
ZP1510RB	310	5	5	横齿 serrated	是 yes
ZP1511RB	310	7	5	横齿 serrated	是 yes
ZP1562RB	340	6	5	横齿 serrated	是 yes
ZP1590RB	420	6	6	横齿 serrated	是 yes

编码 article no.	L(总长) (total length)	杆径 shaft dia.	B(头宽) (tip width)	齿形 jaw teeth	是否带锁止牙 with ratchet
DP1510RB	310	5	5	横齿 serrated	是 yes
DP1511RB	310	7	5	横齿 serrated	是 yes
DP1562RB	340	6	5	横齿 serrated	是 yes
DP1590RB	420	6	6	横齿 serrated	是 yes

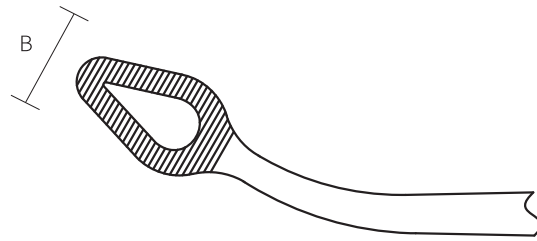

编码 article no.	L(总长) (total length)	杆径 shaft dia.	B(头宽) (tip width)	齿形 jaw teeth	是否带锁止牙 with ratchet
ZP1551RB	310	5	8	横齿 serrated	是 yes
ZP1563RB	340	6	8	横齿 serrated	是 yes

编码 article no.	L(总长) (total length)	杆径 shaft dia.	B(头宽) (tip width)	齿形 jaw teeth	是否带锁止牙 with ratchet
DP1551RB	310	5	8	横齿 serrated	是 yes
DP1563RB	340	6	8	横齿 serrated	是 yes

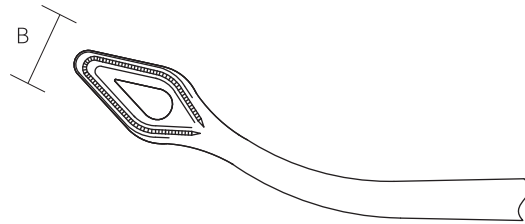

编码 article no.	L(总长) (total length)	杆径 shaft dia.	B(头宽) (tip width)	齿形 atraumatic teeth	是否带锁止牙 with ratchet
ZP1552RB	310	5	8	1×2齿 teeth	是 yes
ZP1553RB	310	5	10	1×2齿 teeth	是 yes
ZP1565RB	340	6	8	1×2齿 teeth	是 yes
ZP1566RB	340	6	10	1×2齿 teeth	是 yes

编码 article no.	L(总长) (total length)	杆径 shaft dia.	B(头宽) (tip width)	齿形 atraumatic teeth	是否带锁止牙 with ratchet
DP1552RB	310	5	8	1×2齿 teeth	是 yes
DP1553RB	310	5	10	1×2齿 teeth	是 yes
DP1565RB	340	6	8	1×2齿 teeth	是 yes
DP1566RB	340	6	10	1×2齿 teeth	是 yes

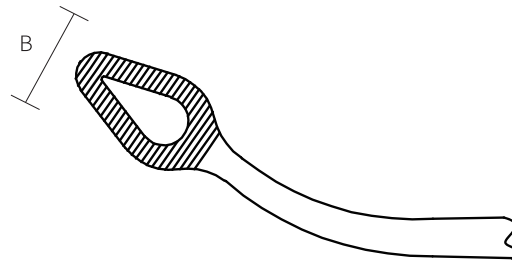

编码 article no.	L(总长) (total length)	杆径 shaft dia.	B(头宽) (tip width)	齿形 jaw teeth	是否带锁止牙 with ratchet
ZP1512RB	310	5	10	横齿 serrated	是 yes
ZP1513RB	310	7	10	横齿 serrated	是 yes
ZP1564RB	340	6	10	横齿 serrated	是 yes

编码 article no.	L(总长) (total length)	杆径 shaft dia.	B(头宽) (tip width)	齿形 jaw teeth	是否带锁止牙 with ratchet
DP1512RB	310	5	10	横齿 serrated	是 yes
DP1513RB	310	7	10	横齿 serrated	是 yes
DP1564RB	340	6	10	横齿 serrated	是 yes

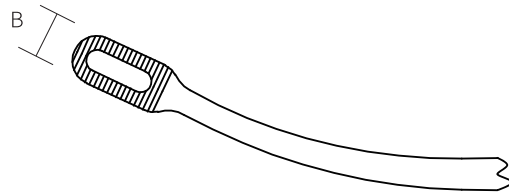

编码 article no.	L(总长) (total length)	杆径 shaft dia.	B(头宽) (tip width)	齿形 jaw teeth	是否带锁止牙 with ratchet
ZP1514RB	330	5	6	横齿 serrated	是 yes
ZP1515RB	330	7	6	横齿 serrated	是 yes

编码 article no.	L(总长) (total length)	杆径 shaft dia.	B(头宽) (tip width)	齿形 jaw teeth	是否带锁止牙 with ratchet
DP1514RB	330	5	6	横齿 serrated	是 yes
DP1515RB	330	7	6	横齿 serrated	是 yes

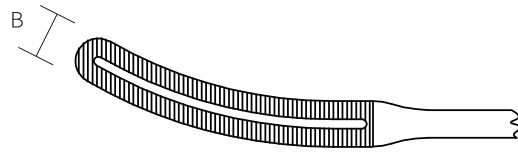

编码 article no.	L(总长) (total length)	杆径 shaft dia.	B(头宽) (tip width)	齿形 jaw teeth	是否带锁止牙 with ratchet
ZP1516RB	340	5	8	横齿 serrated	是 yes
ZP1517RB	340	7	8	横齿 serrated	是 yes

编码 article no.	L(总长) (total length)	杆径 shaft dia.	B(头宽) (tip width)	齿形 jaw teeth	是否带锁止牙 with ratchet
DP1516RB	340	5	8	横齿 serrated	是 yes
DP1517RB	340	7	8	横齿 serrated	是 yes

单孔型·海绵钳 / Sponge forceps, Uniportal

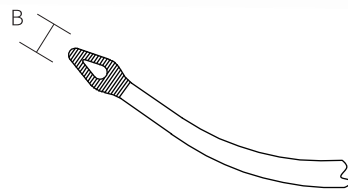
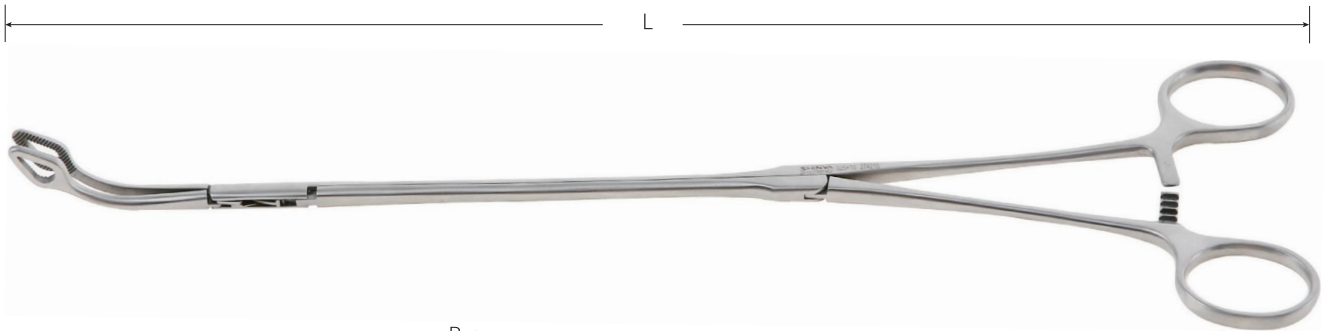

编码 article no.	L(总长) (total length)	杆径 shaft dia.	B(头宽) (tip width)	齿形 jaw teeth	是否带锁止牙 with ratchet	头部打开形式 tip opening
ZP1536RB	325	6	5	横齿 serrated	是 yes	双开 double action

编码 article no.	L(总长) (total length)	杆径 shaft dia.	B(头宽) (tip width)	齿形 jaw teeth	是否带锁止牙 with ratchet	头部打开形式 tip opening
DP1536RB	325	6	5	横齿 serrated	是 yes	双开 double action

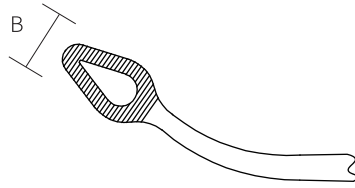

编码 article no.	L(总长) (total length)	杆径 shaft dia.	B(头宽) (tip width)	齿形 jaw teeth	是否带锁止牙 with ratchet	头部打开形式 tip opening
ZP1537RB	325	6	10	横齿 serrated	是 yes	双开 double action

编码 article no.	L(总长) (total length)	杆径 shaft dia.	B(头宽) (tip width)	齿形 jaw teeth	是否带锁止牙 with ratchet	头部打开形式 tip opening
DP1537RB	325	6	10	横齿 serrated	是 yes	双开 double action

单孔型·小切口持针钳 / Uniportal needle holder with TC 0.3 for thin needle, single action

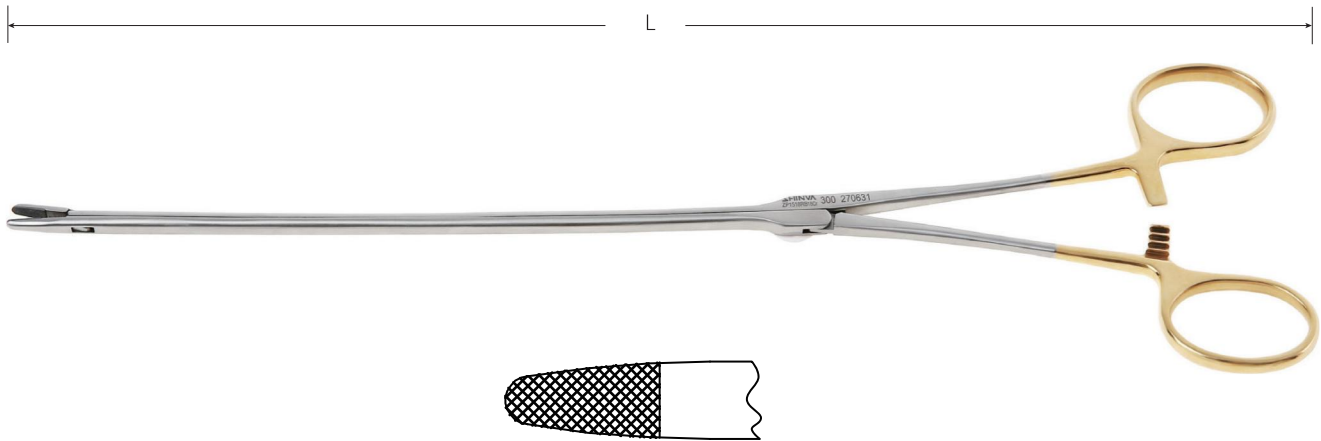

编码 article no.	L(总长) (total length)	杆径 shaft dia.	镶片齿距 insert pitch	头部形式 tip	是否带锁止牙 with ratchet
ZP1518RB	300	5	0.3	直头 straight	是 yes
ZP1573RB	340	6	0.3	直头 straight	是 yes
ZP1597RB	420	6	0.3	直头 straight	是 yes

编码 article no.	L(总长) (total length)	杆径 shaft dia.	镶片齿距 insert pitch	头部形式 tip	是否带锁止牙 with ratchet
DP1518RB	300	5	0.3	直头 straight	是 yes
DP1573RB	340	6	0.3	直头 straight	是 yes
DP1597RB	420	6	0.3	直头 straight	是 yes

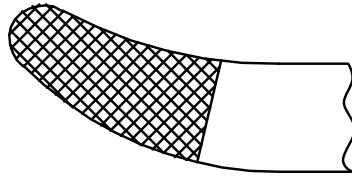

编码 article no.	L (总长) (total length)	杆径 shaft dia.	镶片齿距 insert pitch	头部形式 tip	是否带锁止牙 with ratchet
ZP1519RB	300	5	0.3	弯头 curved	是 yes
ZP1574RB	340	6	0.3	弯头 curved	是 yes
ZP1598RB	420	6	0.3	弯头 curved	是 yes

编码 article no.	L (总长) (total length)	杆径 shaft dia.	镶片齿距 insert pitch	头部形式 tip	是否带锁止牙 with ratchet
DP1519RB	300	5	0.3	弯头 curved	是 yes
DP1574RB	340	6	0.3	弯头 curved	是 yes
DP1598RB	420	6	0.3	弯头 curved	是 yes

单孔型·精细剪 / Uniportal delicate scissors, single action

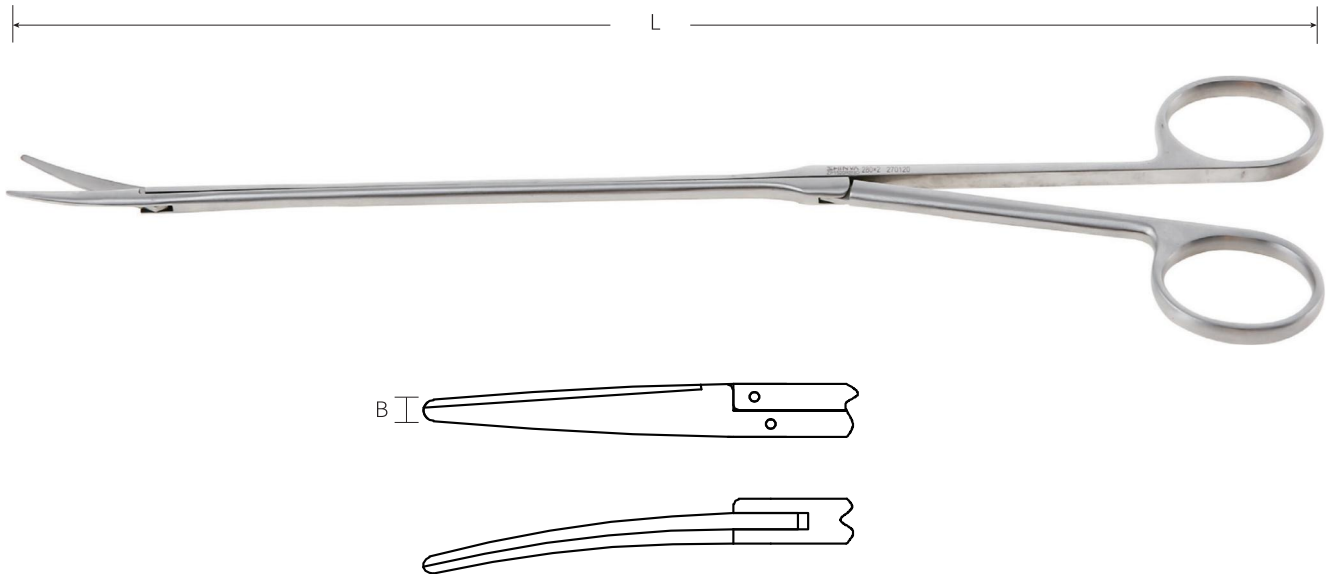

编码 article no.	L (总长) (total length)	杆径 shaft dia.	B (头宽) (tip width)	头部形式 tip
ZP1520RB	280	5	2	窄头 narrow tip
ZP1521RB	280	5	3	宽头 broad tip
ZP1575RB	320	6	2	窄头 narrow tip
ZP1576RB	320	6	3	宽头 broad tip
ZP1599RB	420	6	2	窄头 narrow tip

编码 article no.	L (总长) (total length)	杆径 shaft dia.	B (头宽) (tip width)	头部形式 tip
DP1520RB	280	5	2	窄头 narrow tip
DP1521RB	280	5	3	宽头 broad tip
DP1575RB	320	6	2	窄头 narrow tip
DP1576RB	320	6	3	宽头 broad tip
DP1599RB	420	6	2	窄头 narrow tip

单孔型·夹持钳 / Uniporta holding forceps, Shaft 5mm, single action

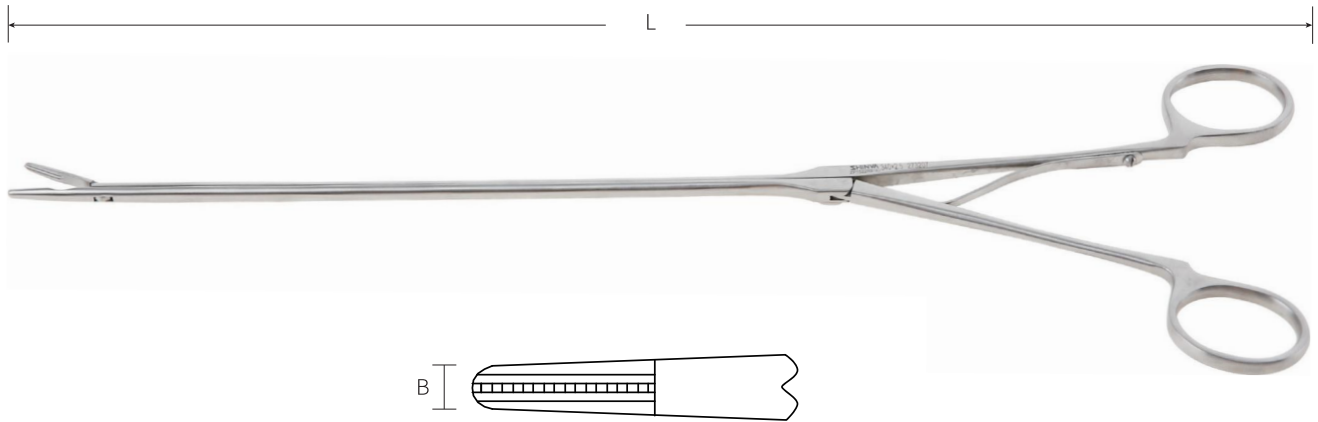

编码 article no.	L(总长) (total length)	杆径 shaft dia.	B(头宽) (tip width)	齿形 atraumatic teeth	头部形式 tip
ZP1522RB	340	5	2.5	1×2齿 teeth	直头 straight
ZP1524RB	340	5	3.2	1×2齿 teeth	直头 straight

编码 article no.	L(总长) (total length)	杆径 shaft dia.	B(头宽) (tip width)	齿形 atraumatic teeth	头部形式 tip
DP1522RB	340	5	2.5	1×2齿 teeth	直头 straight
DP1524RB	340	5	3.2	1×2齿 teeth	直头 straight

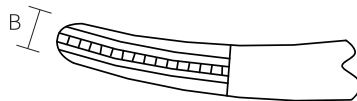

编码 article no.	L(总长) (total length)	杆径 shaft dia.	B(头宽) (tip width)	齿形 atraumatic teeth	头部形式 tip
ZP1523RB	340	5	2.5	1×2齿 teeth	弯头 curved
ZP1525RB	340	5	3.2	1×2齿 teeth	弯头 curved

编码 article no.	L(总长) (total length)	杆径 shaft dia.	B(头宽) (tip width)	齿形 atraumatic teeth	头部形式 tip
DP1523RB	340	5	2.5	1×2齿 teeth	弯头 curved
DP1525RB	340	5	3.2	1×2齿 teeth	弯头 curved

小切口肺叶钳 / MIS lung grasping forceps

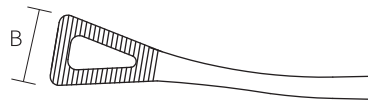
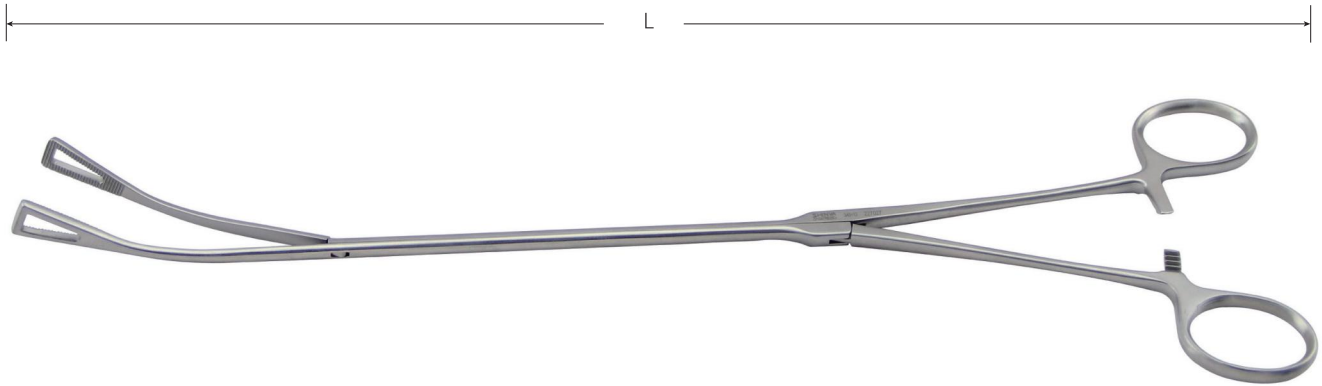

编码 article no.	L(总长) (total length)	杆径 shaft dia.	B(头宽) (tip width)	齿形 jaw teeth	是否带锁止牙 with ratchet
ZP1547RB	340	5.5	12	横齿 serrated	是 yes
ZP1186RB	360	8	12	横齿 serrated	是 yes

编码 article no.	L(总长) (total length)	杆径 shaft dia.	B(头宽) (tip width)	齿形 jaw teeth	是否带锁止牙 with ratchet
DP1547RB	340	5.5	12	横齿 serrated	是 yes

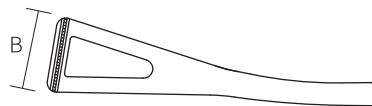

编码 article no.	L(总长) (total length)	杆径 shaft dia.	B(头宽) (tip width)	齿形 atraumatic teeth	是否带锁止牙 with ratchet
ZP1586RB	360	6	12	1×2齿 teeth	是 yes

编码 article no.	L(总长) (total length)	杆径 shaft dia.	B(头宽) (tip width)	齿形 atraumatic teeth	是否带锁止牙 with ratchet
DP1586RB	360	6	12	1×2齿 teeth	是 yes

小切口组织钳 / MIS tissue forceps



编码 article no.	L(总长) (total length)	杆径 shaft dia.	B(头宽) (tip width)	齿形 jaw teeth	是否带锁止牙 with ratchet
ZP1542RB	340	5.5	8	横齿 serrated	是 yes
ZP1182RB	360	8	6	横齿 serrated	是 yes

编码 article no.	L(总长) (total length)	杆径 shaft dia.	B(头宽) (tip width)	齿形 jaw teeth	是否带锁止牙 with ratchet
DP1542RB	340	5.5	8	横齿 serrated	是 yes

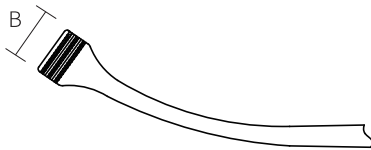

编码 article no.	L(总长) (total length)	杆径 shaft dia.	B(头宽) (tip width)	齿形 atraumatic teeth	是否带锁止牙 with ratchet
ZP1543RB	340	5.5	8	2×3齿 teeth	是 yes

编码 article no.	L(总长) (total length)	杆径 shaft dia.	B(头宽) (tip width)	齿形 atraumatic teeth	是否带锁止牙 with ratchet
DP1543RB	340	5.5	8	2×3齿 teeth	是 yes

小切口淋巴钳 / MIS lymphatic forceps

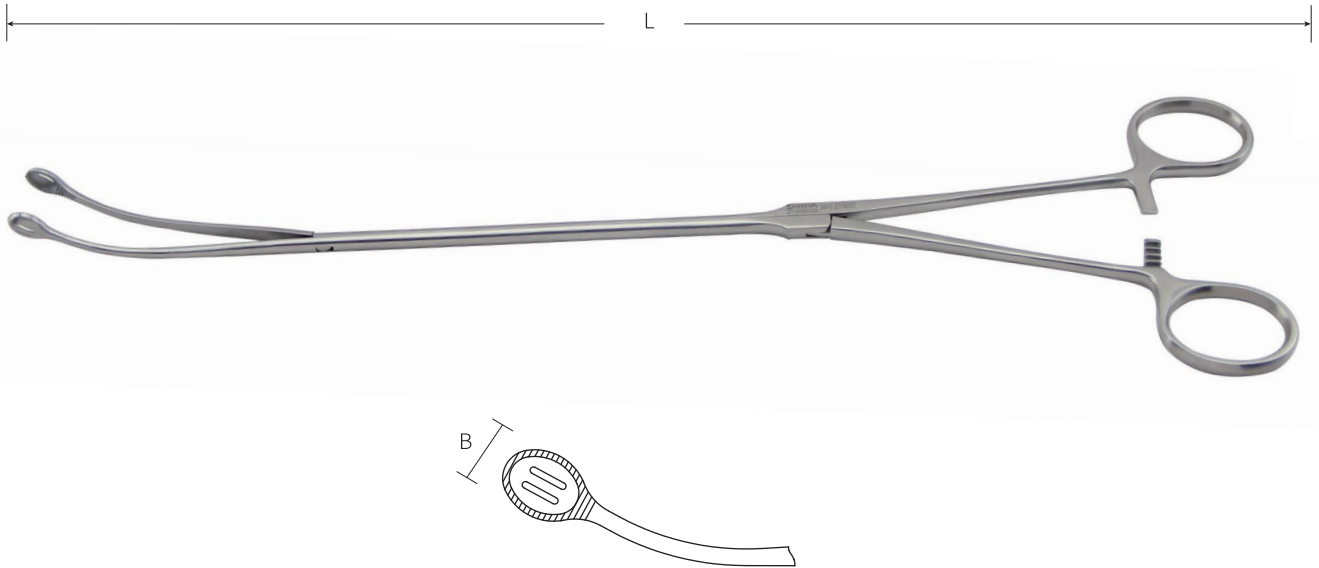

编码 article no.	L (总长) (total length)	杆径 shaft dia.	B (头宽) (tip width)	齿形 jaw teeth	是否带锁止牙 with ratchet
ZP1544RB	340	5	8	横齿 serrated	是 yes
ZP1545RB	340	5	10	横齿 serrated	是 yes
ZP1546RB	340	5	12	横齿 serrated	是 yes
ZP1178RB	360	8	10	横齿 serrated	是 yes
ZP1179RB	360	8	12	横齿 serrated	是 yes

编码 article no.	L (总长) (total length)	杆径 shaft dia.	B (头宽) (tip width)	齿形 jaw teeth	是否带锁止牙 with ratchet
DP1544RB	340	5	8	横齿 serrated	是 yes
DP1545RB	340	5	10	横齿 serrated	是 yes
DP1546RB	340	5	12	横齿 serrated	是 yes

小切口组织钳 / MIS tissue forceps



**ZP1710RB** 250×10,直 Straight

**ZP1711RB** 250×12,直 Straight

单孔型·器械钳 / Clip applying forceps, single action (不包含止血夹) (not including the clip)

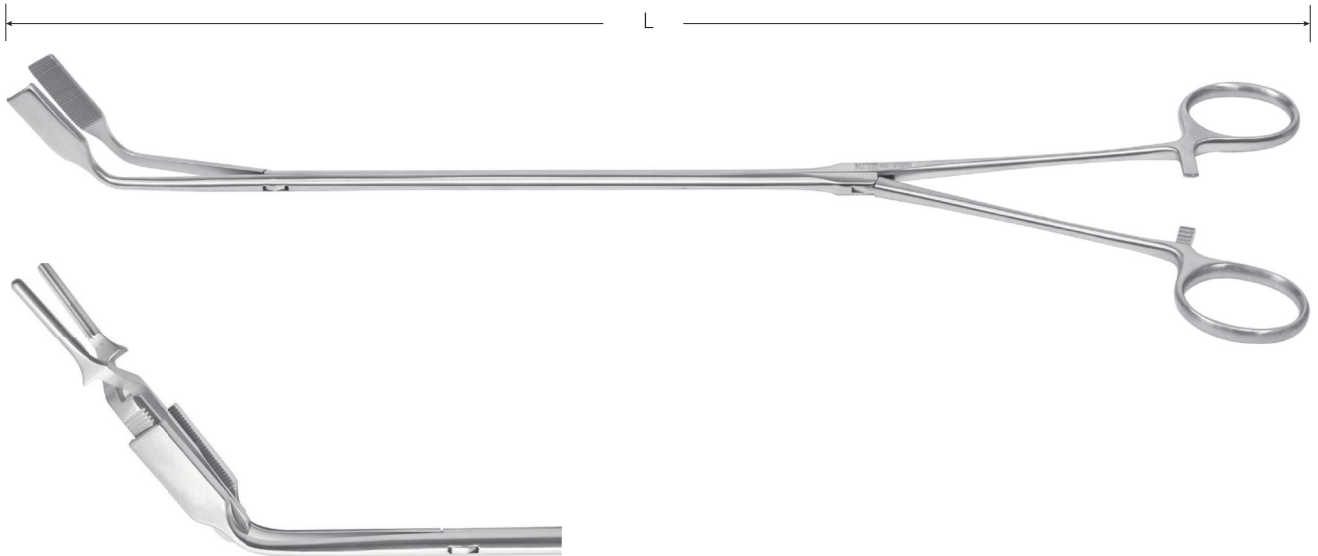

编码 article no.	L(总长) (total length)	杆径 shaft dia.	搭配使用器械 for clip type	是否带锁止牙 with ratchet
ZP1584RB	360	8	反力式止血夹 bulldog clamp	是 yes

编码 article no.	L(总长) (total length)	杆径 shaft dia.	搭配使用器械 for clip type	是否带锁止牙 with ratchet
DP1584RB	360	8	反力式止血夹 bulldog clamp	是 yes

血管钳 / Vascular clamp

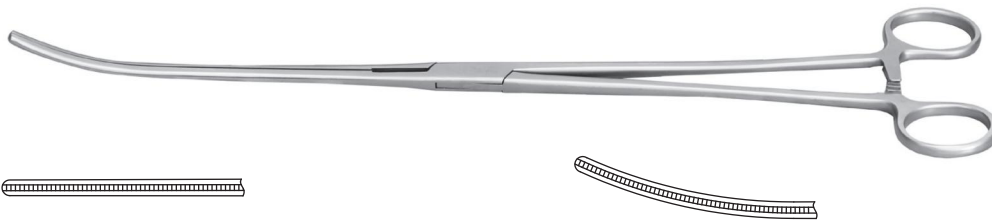

**ZL1101RN**  
320, 钳式, 直, 小切口

**ZL1102RN**  
320, 钳式, 直, 无锁止牙, 小切口  
Without ratchet

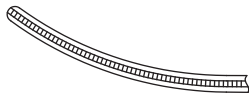

**ZL1104RN**  
320×154×15, 钳式, 弯, 小切口

**ZL1109RN**  
320×154×15, 钳式, 弯, 无锁止牙, 小切口  
Without ratchet

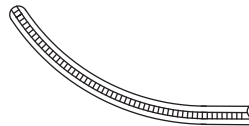

**ZL1105RN**  
320×151×20, 钳式, 弯, 小切口

**ZL1110RN**  
320×151×20, 钳式, 弯, 无锁止牙, 小切口  
Without ratchet

**ZL1106RN**  
320×148×25, 钳式, 弯, 小切口

**ZL1111RN**  
320×148×25, 钳式, 弯, 无锁止牙, 小切口  
Without ratchet

血管钳 / Vascular clamp

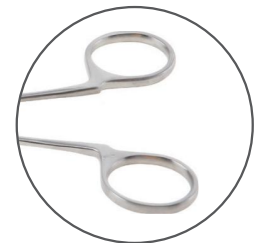

**ZL1114RN**  
320×22×90°, 钳式, 弯, 小切口

**ZL1119RN**  
320×22×90°, 钳式, 弯,  
无锁止牙, 小切口  
Without ratchet

**ZL1115RN**  
320×25×90°, 钳式, 弯, 小切口

**ZL1120RN**  
320×25×90°, 钳式, 弯,  
无锁止牙, 小切口  
Without ratchet

**ZL1116RN**  
320×28×90°, 钳式, 弯, 小切口

**ZL1121RN**  
320×28×90°, 钳式, 弯,  
无锁止牙, 小切口  
Without ratchet

分离结扎钳 / Dissecting and ligature forceps



**ZH457RN**  
 320×155×8, 钳式, 弯, 小切口

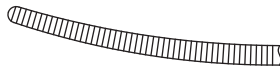

**ZH458RN**  
 320×150×12, 钳式, 弯, 小切口

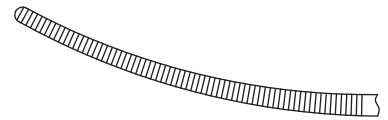

**ZH461RN**  
 320×150×22, 钳式, 弯, 小切口

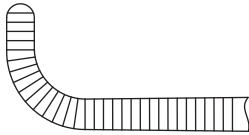

**ZH463RN**  
 320×15×90°, 钳式, 弯, 小切口

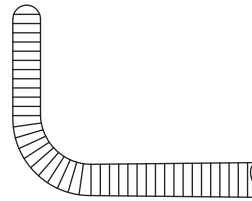

**ZH466RN**  
 320×22×90°, 钳式, 弯, 小切口

海绵钳 / Sponge forceps

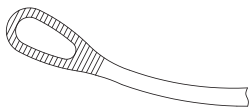

**ZE243RN** 320×8, 钳式, 弯有齿, 短杆, 小切口  
**ZE244RN** 320×10, 钳式, 弯有齿, 短杆, 小切口  
**ZE245RN** 320×12, 钳式, 弯有齿, 短杆, 小切口

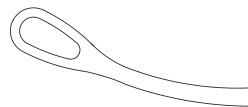

**ZE246RN** 320×8, 钳式, 弯无齿, 短杆, 小切口  
**ZE247RN** 320×10, 钳式, 弯无齿, 短杆, 小切口  
**ZE248RN** 320×12, 钳式, 弯无齿, 短杆, 小切口

海绵钳 / Sponge forceps

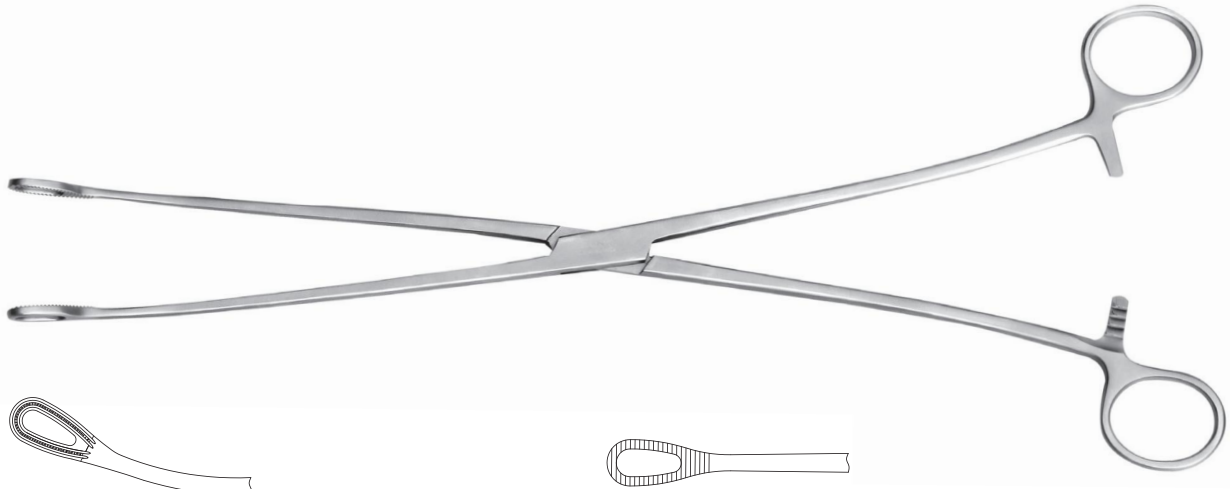

**ZE174RN** 320×8, 钳式, 弯, 小切口

**ZE175RN** 320×10, 钳式, 弯, 小切口

**ZE176RN** 320×12, 钳式, 弯, 小切口

**ZE177RN** 320×8, 钳式, 直有齿, 小切口

**ZE178RN** 320×10, 钳式, 直有齿, 小切口

**ZE179RN** 320×12, 钳式, 直有齿, 小切口

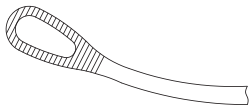

**ZE183RN** 320×8, 钳式, 弯有齿, 小切口

**ZE184RN** 320×10, 钳式, 弯有齿, 小切口

**ZE185RN** 320×12, 钳式, 弯有齿, 小切口



**ZE186RN** 320×8, 钳式, 弯无齿, 小切口

**ZE187RN** 320×10, 钳式, 弯无齿, 小切口

**ZE188RN** 320×12, 钳式, 弯无齿, 小切口

精细剪 / Delicate scissors

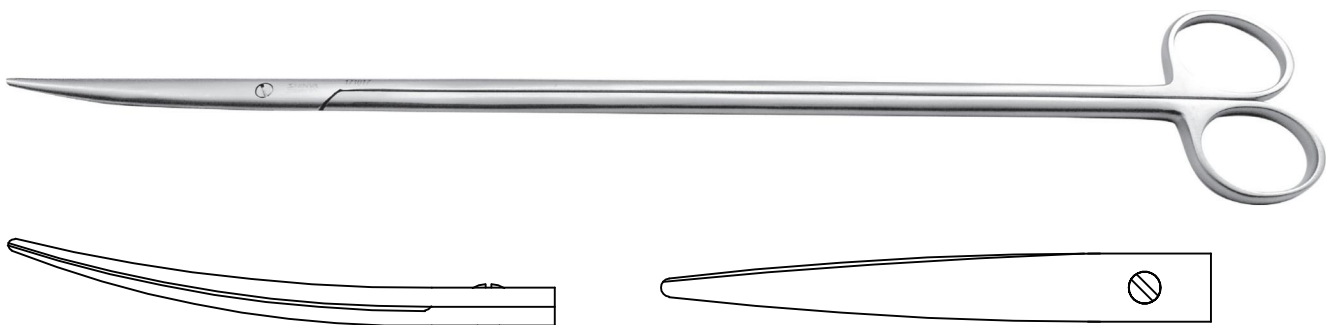

**ZC868RN**  
320, 钳式, 单关节, 弯, 窄头, 小切口  
With narrow tip

**ZC869RN**  
320, 钳式, 单关节, 弯, 宽头, 小切口  
With broad tip

精细剪 / Delicate scissors



**ZP1286RN**

320, 钳式, 双关节, 弯, 窄头, 小切口  
 With narrow tip

小切口组织钳 / MIS tissue forceps

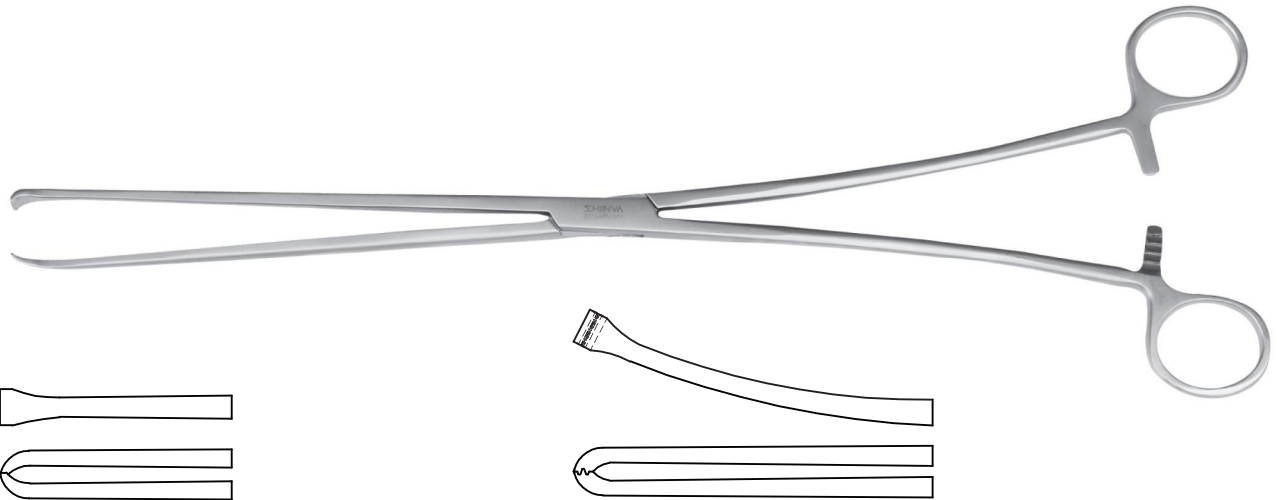

**ZE193RN**

320×6, 钳式, 直

**ZE194RN**

320×9, 钳式, 直

**ZE199RN**

320×6, 钳式, 弯, 无损伤1×2 齿

**ZE196RN**

320×15, 钳式, 直

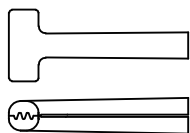

**ZE201RN**

320×12, 钳式,  
 T形, 无损伤2×3 齿

**ZE202RN**

320×16, 钳式,  
 T形, 无损伤2×3 齿



**ZE210RN**

320×8, 钳式, 匙形, 淋巴

**ZE211RN**

320×11, 钳式, 匙形, 淋巴

**ZE212RN**

320×14, 钳式, 匙形, 淋巴

## 手术刀柄 / Scalpel handle



### ZP1354RB

340

适配9#-17#手术刀片 for 9#-17# blades

### Micro hook



### ★ZP1352RB

340×5, 小切口

### ★ZP1353RB

340×9, 小切口

### ZP1355RB

340×4.5, 球头, 小切口

## 剥离器 / Mediastinal retractor



ZP1708RB 420×φ5 (不带吸引)

ZP1724RB 335×φ5 (带吸引)

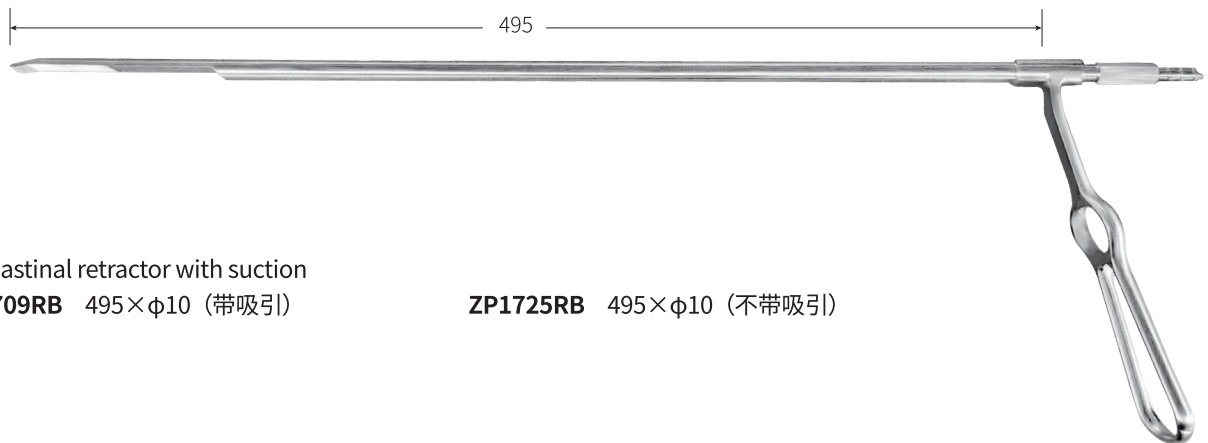

### Mediastinal retractor with suction

ZP1709RB 495×φ10 (带吸引)

ZP1725RB 495×φ10 (不带吸引)

小切口手术缝合线拉钩 / MIS suture hook



**ZP1311RN** 240×Φ5  
**ZP1313RN** 280×Φ5



★ **ZP1314RN**  
 380×Φ5

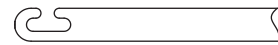

**ZP1317RN**  
 380×Φ5

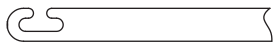

**ZP1377RN**  
 250×Φ2.5直, 环形圆头

**ZP1380RN**  
 370×Φ2.5直, 环形圆头



**ZP1383RN**  
 370×Φ1.5直, 镰状尖头

**ZP1384RN**  
 370×Φ2.0直, 镰状尖头

**ZP1385RN**  
 370×Φ2.5直, 镰状尖头



**ZP1539RB**  
 330, 回型



**ZP1540RB**  
 330, U型, 左向 Left

**ZP1541RB**  
 330, U型, 右向 Right

吸引管 / Suction tube



★ **ZP1613RN**  
 320×Φ5, 弯, 45°



★ **ZP1538RB**  
 380, 双弯, 小切口

吸引管 / Suction tube

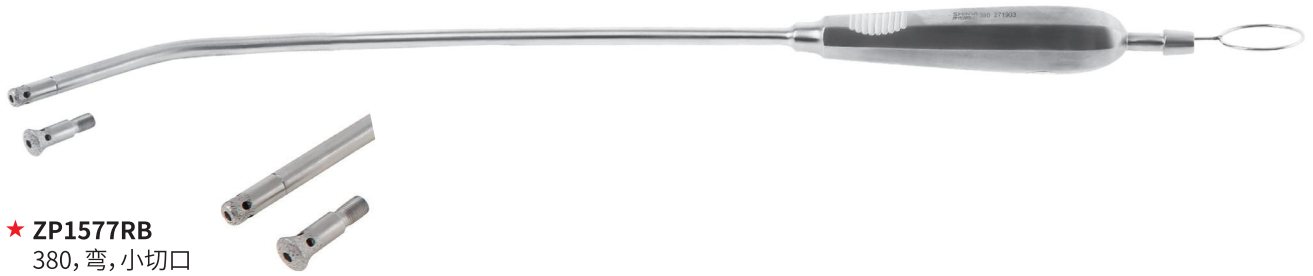

★ **ZP1577RB**  
 380, 弯, 小切口



**ZP1332RN**  
 360×Φ6, 弯形平头, 小切口

**ZP1339RN**  
 450×Φ6, 弯形平头, 小切口

**ZP1333RN**  
 360×Φ6, 角弯平头, 小切口



**ZP1334RN**  
 360×Φ6, 角弯喇叭头,  
 小切口



**ZP1340RN**  
 450×Φ6,  
 弯形喇叭头,  
 小切口



**ZP1578RB**  
 450×Φ6,  
 弯形喇叭头,  
 小切口, 磨砂面  
 With frosted surface



★ **ZP1589RB**  
 385×Φ5, 弯,  
 小切口



外科牵开器 / Surgical retractor

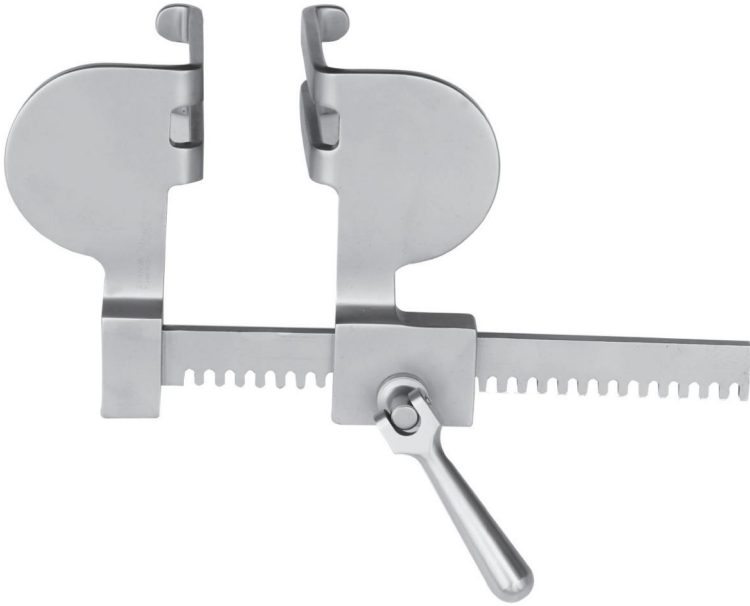

**ZL844RN**  
双叶, 固定式, 30×40, 小切口

**ZL845RN**  
双叶, 固定式, 30×60, 小切口



**ZL846RN**  
单叶, 固定式, 36×45 附拉钩, 小切口

**ZL847RN**  
单叶, 固定式, 36×60 附拉钩, 小切口

外科牵开器 / Surgical retractor



**ZL848RN**  
单叶, 固定式, 30×46 附拉钩, 小切口

**ZL849RN**  
单叶, 固定式, 30×66 附拉钩, 小切口

**ZL996RB**  
组合式, 小切口

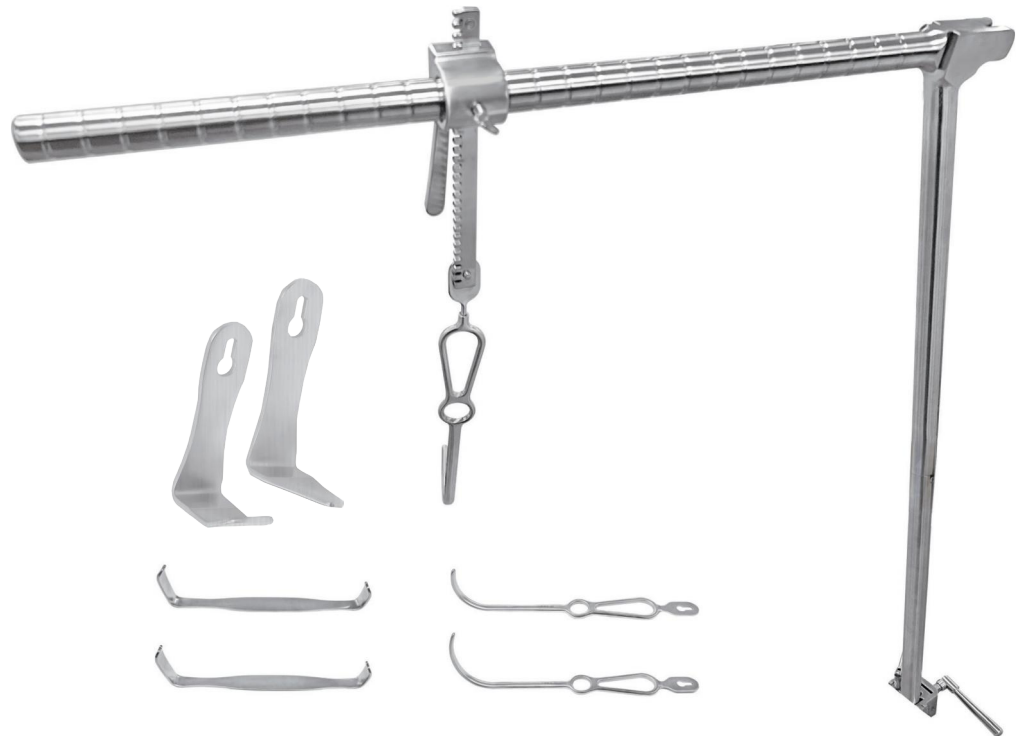

外科牵开器 / Surgical retractor

**ZL869RG**

单叶, 拆卸式, 附叶片, 附拉钩, 小切口

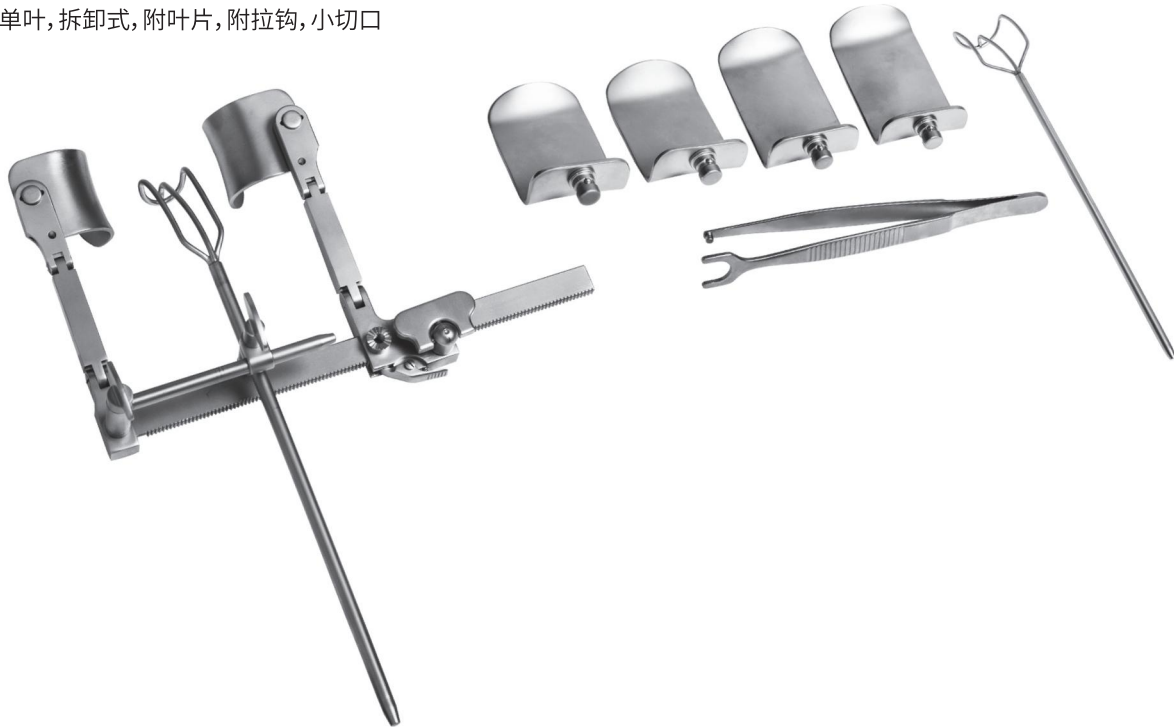

**ZL991RN**

130×110, 单叶, 小切口



成套器械包  
Surgical Instrument Set

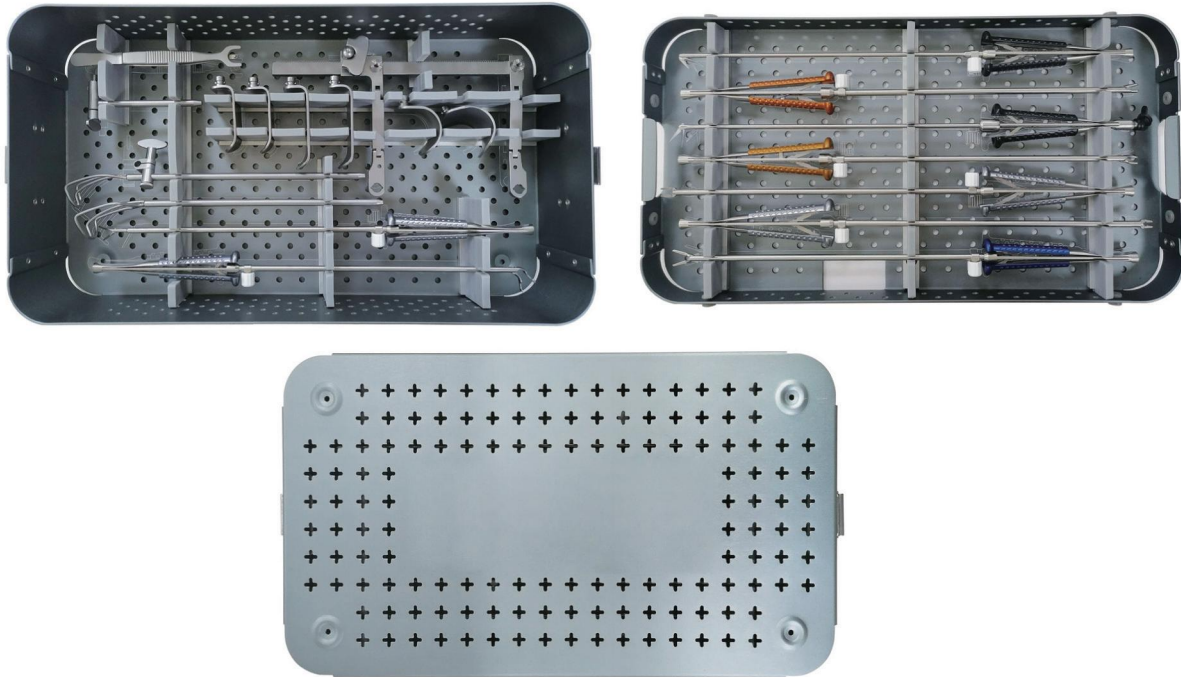

XQ- I 型胸腔外科手术器械包 (微创搭桥包) (ZL181)  
XQ- I type MIS Heart Bypass Instruments set (ZL181)

序号 NO.	产品编码 Article NO.	产品名称 / 规格型号 Description	数量 Unit	单位 Qty
1	JP1643RB	小切口持针钳 250, 直, 单开, 镶片, 握笔管式 MIS needle holder, 250, straight, TC, single action	1	把 pc
2	JP1646RB	小切口持针钳 250, 弯, 单开, 镶片, 握笔管式 MIS needle holder, 250, curved, TC, single action	1	把 pc
3	JP1703RB	夹持钳 250, 握笔管式 grasping forceps, 250, Titanium clip applier, small	1	把 pc
4	JP1706RB	夹持钳 250, 握笔管式 grasping forceps, 250, Titanium clip applier, large	1	把 pc
5	JP1691RB	夹持钳 250, 上翘45°, 单开, 握笔管式 grasping forceps, single action, 250, upwards curved 45°	1	把 pc
6	JP1667RB	夹持钳 250×1.5, 1×2凹凸齿, 直头, 双开握笔管式 grasping forceps, double action, atraumatic, 250×1.5, 1×2teeth, straight	1	把 pc
7	JP1685RB	夹持钳 250×1.5, 1×2凹凸齿, 角弯单开, 握笔管式 grasping forceps, single action, atraumatic, 250×1.5, 1×2teeth, angled curved	1	把 pc
8	JP1622RB	精细剪 250, 弯45°, 单开, 握笔管式 delicate scissors, 250, curved45°, single action	1	把 pc
9	JP1628RB	精细剪 250, 弯125°, 单开, 握笔管式 delicate scissors, 250, curved125°, single action	1	把 pc
10	ZL869RG	外科牵开器 单叶, 拆卸式, 附叶片, 附拉钩, 小切口 surgical retractor, detachable, MIS	1	把 pc

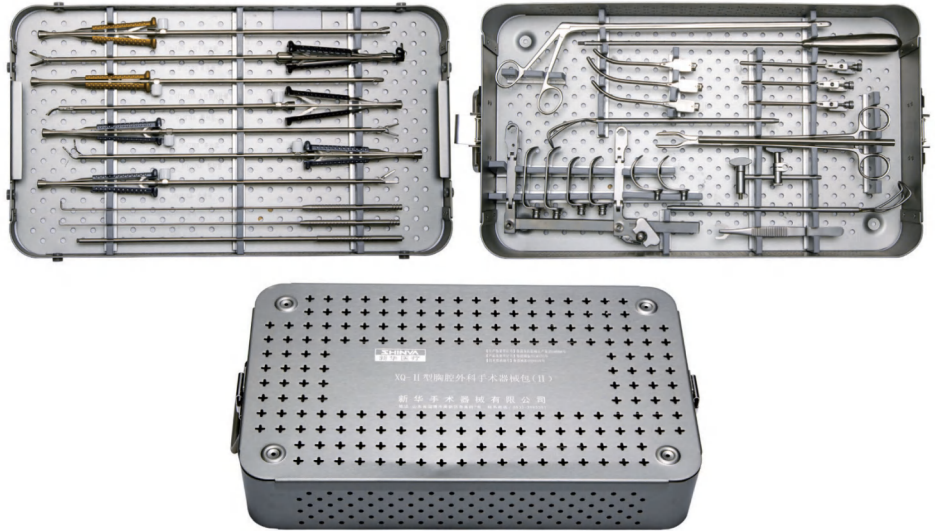

**XQ-II型胸腔外科手术器械包(微创瓣膜包) (ZL182)**  
XQ-II type MIS Valve Replacement Instruments Set (ZL182)

序号 NO.	产品编码 Article NO.	产品名称 / 规格型号 Description	数量 Unit	单位 Qty
1	JP1610RB	精细剪 250, 弯, 双开握笔管式 delicate scissors, 250, curved, double action	1	把 pc
2	JP1613RB	精细剪 250, 弯, 双开, 握笔管式 delicate scissors, 250, curved, double action	1	把 pc
3	JP1643RB	小切口持针钳 250, 直, 单开, 镶片, 握笔管式 MIS needle holder, 250, straight, TC, single action	1	把 pc
4	JP1646RB	小切口持针钳 250, 弯, 单开, 镶片, 握笔管式 MIS needle holder, 250, curved, TC, single action	1	把 pc
5	JP1673RB	夹持钳 250×2.8, 1×2凹凸齿, 直头, 双开, 握笔管式 grasping forceps, double action, atraumatic, 250×2.8, 1×2teeth, straight	1	把 pc
6	JP1676RB	夹持钳 250×3, 直头, 单开, 握笔管式 grasping forceps, single action, 250×3, straight	1	把 pc
7	JP1691RB	夹持钳 250, 上翘45°单开, 握笔管式 grasping forceps, single action, 250, upwards curved 45°	1	把 pc
8	ZL869RG	外科牵开器 单叶, 拆卸式, 附叶片, 附拉钩, 小切口 surgical retractor, detachable, MIS	1	把 pc
9	ZP1352RB	显微钩 340×5, 小切口 micro hook, 340×5, MIS	1	把 pc
10	ZP1353RB	显微钩 340×9, 小切口 micro hook, 340×9, MIS	1	把 pc
11	ZP1354RB	手术刀柄 340 scalpel handle, 340	1	把 pc
12	ZF1756RB	髓核钳 300×3, 指圈式 laminectomy forceps, 300×3	1	把 pc
13	ZL1130RB	血管钳 135, 直 vascular clamp, 135, straight	1	把 pc
14	ZL1131RB	血管钳 120, 直 vascular clamp, 120, straight	1	把 pc
15	ZL1132RB	血管钳 110, 直 vascular clamp, 110, straight	1	把 pc
16	ZL1133RB	血管钳 130, 弯 vascular clamp, 130, curved	1	把 pc
17	ZL1134RB	血管钳 120, 弯 vascular clamp, 120, curved	1	把 pc
18	ZL1135RB	血管钳 110, 弯 vascular clamp, 110, curved	1	把 pc
19	ZL1136RB	起子 350 screwdriver, 350	1	把 pc
20	ZL1137RB	夹持钳 250 grasping forceps, 250	1	把 pc

成套器械包  
Surgical Instrument Set



### I 型 微创小切口双关节器械包 (ZP1579) I type MIS Incision Double Joint Instrument Set (ZP1579)

序号 NO.	产品编码 Article NO.	产品名称 / 规格型号 Description	数量 Unit	单位 Qty
1	ZP1567RB	血管钳 360×15,滑板式,圆弯,1×2齿 vascular clamp, single action, 360×15, curved, 1*2teeth	1	把 pc
2	ZP1568RB	血管钳 360×20,滑板式,圆弯,1×2齿 vascular clamp, single action, 360×20, curved, 1*2teeth	1	把 pc
3	ZP1569RB	血管钳 360×25,滑板式,圆弯,1×2齿 vascular clamp, single action, 360×25, curved, 1*2teeth	1	把 pc
4	ZP1570RB	血管钳 360×25×90°,滑板式,弯,1×2齿 vascular clamp, single action, 360×25×90°, curved, 1*2teeth	1	把 pc
5	ZP1571RB	血管钳 360×18×90°,滑板式,弯,1×2齿 vascular clamp, single action, 360×18×90°, curved, 1*2teeth	1	把 pc
6	ZP1572RB	血管钳 360×75×30,滑板式,圆弯,1×2齿 vascular clamp, single action, 360×75×30, curved, 1*2teeth	1	把 pc
7	ZP1562RB	海绵钳 340×5,滑板式,弯,有槽,小切口 sponge forceps, 340×5, curved, MIS	1	把 pc
8	ZP1564RB	海绵钳 340×10,滑板式,弯,有槽,小切口 sponge forceps, 340×10, curved, MIS	1	把 pc
9	ZP1172RB	海绵钳 360×10,滑板式,弯有齿,小切口 MIS sponge forceps, 360×10, curved, with teeth, shaft 8mm	1	把 pc
10	ZP1173RB	海绵钳 360×8,滑板式,弯有齿,小切口 MIS sponge forceps, 360×8, curved, with teeth, shaft 9mm	1	把 pc
11	ZP1574RB	小切口持针钳 340,滑板式,弯,细针,镶片0.3 needle holder with TC 0.3 for thin needle, 340, shaft 6mm, curved	1	把 pc
12	ZP1575RB	精细剪. 320×2,滑板式,弯,窄头 delicate scissors, shaft 6mm, 320×2, curved	1	把 pc
13	ZP1182RB	小切口组织钳 360×6,弯,滑板式 MIS tissue forceps, 360×6, curved	1	把 pc
14	ZP1545RB	小切口组织钳 340×10,滑板式,匙形,淋巴 MIS lymphatic forceps, 340×10, shaft 5mm	1	把 pc
15	ZP1314RN	小切口手术缝合线拉钩 380×中5 small incision suture hook, 380×Φ5	1	把 pc
16	ZP1577RB	吸引管 380,弯,小切口 MIS suction tube, 380, curved	1	把 pc

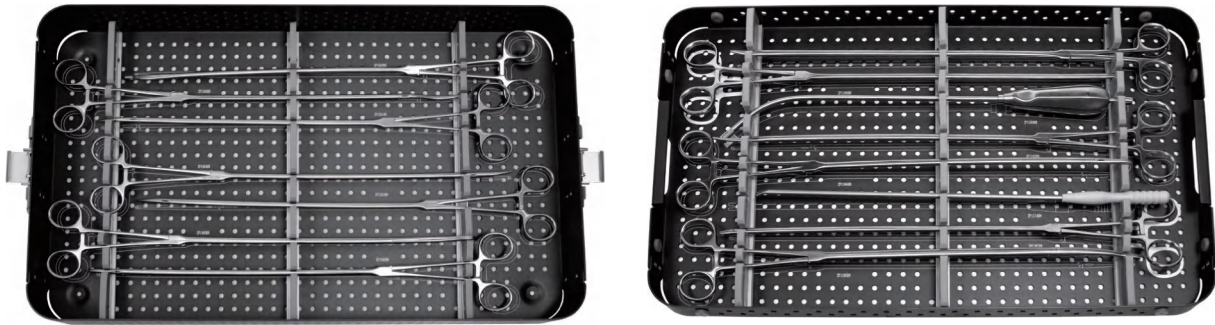

## II 型 微创小切口双关节器械包 (ZP1608) II type MIS Incision Double Joint Instrument Set (ZP1608)

序号 NO.	产品编码 Article NO.	产品名称 / 规格型号 Description	数量 Unit	单位 Qty
1	ZP1314RN	小切口手术缝合线拉钩 380×φ5 small incision suture hook, 380×φ5	1	把 pc
2	ZP1560RB	海绵钳 420×10, 滑板式, 弯有齿, 小切口 MIS sponge forceps, 420×10, curved, with teeth	1	把 pc
3	ZP1561RB	海绵钳 420×10, 滑板式, 弯无齿, 小切口 MIS sponge forceps, 420×10, curved	1	把 pc
4	ZP1589RB	吸引管 385×φ5, 弯, 小切口 suction tube, 380×φ5, curved, MIS	1	把 pc
5	ZP1590RB	海绵钳 420×6, 滑板式, 弯, 有槽, 小切口 MIS sponge forceps, 420*6, curved	1	把 pc
6	ZP1591RB	血管钳 420×20×90°, 滑板式, 弯, 1×2齿 vascular clamp, single action, 420×20×90°, curved, 1×2teeth	1	把 pc
7	ZP1592RB	血管钳 420×10, 滑板式, 圆弯, 1×2齿 vascular clamp, single action, 420×10, curved, 1×2teeth	2	把 pc
8	ZP1593RB	血管钳 420×15, 滑板式, 圆弯, 1×2齿 vascular clamp, single action, 420×15, curved, 1×2teeth	2	把 pc
9	ZP1594RB	血管钳 420×20, 滑板式, 圆弯, 1×2齿 vascular clamp, single action, 420×20, curved, 1×2teeth	1	把 pc
10	ZP1595RB	血管钳 420×25, 滑板式, 圆弯, 1×2齿 vascular clamp, single action, 420×25, curved, 1×2teeth	2	把 pc
11	ZP1596RB	血管钳 420×25×90°, 滑板式, 弯, 1×2齿 vascular clamp, single action, 420×25×90°, curved, 1×2teeth	1	把 pc
12	ZP1597RB	小切口持针钳 420, 滑板式, 直, 细针, 镶片0.3 needle holder with TC 0.3 for thin needle, 420, shaft 6mm, straight	1	把 pc
13	ZP1598RB	小切口持针钳 420, 滑板式, 弯, 细针, 镶片0.3 needle holder with TC 0.3 for thin needle, 420, shaft 6mm, curved	1	把 pc
14	ZP1599RB	精细剪 420×2, 滑板式, 弯, 窄头 delicate scissors, 420*2, curved, shaft 6mm	1	把 pc
15	ZP1600RB	血管钳 420×75×30, 滑板式, 圆弯, 1×2齿 vascular, 420×75×30, curved, 1×2teeth	1	把 pc

成套器械包  
Surgical Instrument Set



III型 微创小切口双关节器械包 (ZP1609)  
III type MIS Incision Double Joint Instrument Set (ZP1609)

序号 NO.	产品编码 Article NO.	产品名称 / 规格型号 Description	数量 Unit	单位 Qty
1	ZP1567RB	血管钳 360×15, 滑板式, 圆弯, 1×2齿 vascular clamp, single action, 360×15, curved, 1*2teeth	1	把 pc
2	ZP1568RB	血管钳 360×20, 滑板式, 圆弯, 1×2齿 vascular clamp, single action, 360×20, curved, 1*2teeth	1	把 pc
3	ZP1569RB	血管钳 360×25, 滑板式, 圆弯, 1×2齿 vascular clamp, single action, 360×25, curved, 1*2teeth	1	把 pc
4	ZP1570RB	血管钳 360×25×90°, 滑板式, 弯, 1×2齿 vascular clamp, single action, 360×25×90°, curved, 1*2teeth	1	把 pc
5	ZP1562RB	海绵钳 340×5, 滑板式, 弯, 有槽, 小切口 sponge forceps, 340×5, curved, MIS	1	把 pc
6	ZP1605RB	海绵钳 360×8, 滑板式, 弯有齿, 小切口 MIS sponge forceps, 360×8, curved, with teeth	1	把 pc
7	ZP1606RB	海绵钳 360×10, 滑板式, 弯有齿, 小切口 MIS sponge forceps, 360×10, curved, with teeth	1	把 pc
8	ZP1573RB	小切口持针钳 340, 滑板式, 直, 细针, 镶片0.3 needle holder with TC 0.3 for thin needle, 340, shaft 6mm, straight	1	把 pc
9	ZP1575RB	精细剪 320×2, 滑板式, 弯, 窄头 delicate scissors, shaft 6mm, 320×2, curved	1	把 pc
10	ZP1544RB	小切口组织钳 340×8, 滑板式, 匙形, 淋巴 MIS lymphatic forceps, 340×8, shaft 5mm	1	把 pc
11	ZP1314RN	小切口手术缝合线拉钩 380×中5 small incision suture hook, 380×Φ5	1	把 pc
12	ZP1589RB	吸引管 385×中5, 弯, 小切口 suction tube, 380×Φ5, curved, MIS	1	把 pc



### IV型 微创小切口双关节器械包 (ZP1610) IV type MIS Incision Double Joint Instrument Set (ZP1610)

序号 NO.	产品编码 Article NO.	产品名称 / 规格型号 Description	数量 Unit	单位 Qty
1	ZP1567RB	血管钳 360×15, 滑板式, 圆弯, 1×2齿 vascular clamp, single action, 360×15, curved, 1*2teeth	1	把 pc
2	ZP1568RB	血管钳 360×20, 滑板式, 圆弯, 1×2齿 vascular clamp, single action, 360×20, curved, 1*2teeth	1	把 pc
3	ZP1569RB	血管钳 360×25, 滑板式, 圆弯, 1×2齿 vascular clamp, single action, 360×25, curved, 1*2teeth	1	把 pc
4	ZP1570RB	血管钳 360×25×90°, 滑板式, 弯, 1×2齿 vascular clamp, single action, 360×25×90°, curved, 1*2teeth	1	把 pc
5	ZP1581RB	血管钳 360×15×110°, 滑板式, 弯, 1×2齿 vascular clamp, 360×15×110°, curved, 1×2teeth	1	把 pc
6	ZP1562RB	海绵钳 340×5, 滑板式, 弯, 有槽, 小切口 sponge forceps, 340×5, curved, MIS	1	把 pc
7	ZP1563RB	海绵钳 340×8, 滑板式, 弯, 有槽, 小切口 sponge forceps, 340×8, curved, MIS	1	把 pc
8	ZP1605RB	海绵钳 360×8, 滑板式, 弯有齿, 小切口 MIS sponge forceps, 360×8, curved, with teeth	1	把 pc
9	ZP1606RB	海绵钳 360×10, 滑板式, 弯有齿, 小切口 MIS sponge forceps, 360×10, curved, with teeth	1	把 pc
10	ZP1602RB	海绵钳 360×8, 滑板式, 弯无齿, 小切口 MIS sponge forceps, 360×8, curved	1	把 pc
11	ZP1603RB	海绵钳 360×10, 滑板式, 弯无齿, 小切口 MIS sponge forceps, 360×10, curved	1	把 pc
12	ZP1607RB	海绵钳 360×12, 滑板式, 弯有齿, 小切口 MIS sponge forceps, 360×12, curved, with teeth	1	把 pc
13	ZP1573RB	小切口持针钳 340, 滑板式, 直, 细针, 镶片0.3 needle holder with TC 0.3 for thin needle, 340, shaft 6mm, straight	1	把 pc
14	ZP1575RB	精细剪 320×2, 滑板式, 弯, 窄头 delicate scissors, shaft 6mm, 320×2, curved	1	把 pc
15	ZP1544RB	小切口组织钳 340×8, 滑板式, 匙形, 淋巴 MIS lymphatic forceps, 340×8, shaft 5mm	1	把 pc
16	ZP1314RN	小切口手术缝合线拉钩 380×φ5 small incision suture hook, 380×φ5	1	把 pc
17	ZP1589RB	吸引管 385×φ5, 弯, 小切口 suction tube, 380×φ5, curved, MIS	1	把 pc

0  
1  
2  
3  
4  
5  
6  
7  
8  
9  
10  
11  
12  
13  
14  
15  
16  
17  
18  
19  
20  
21  
22  
23  
24  
25  
26  
27

# 质量, 我们迈向成功之路

QUALITY - OUR WAY TO SUCCESS



地址: 山东省淄博市高新区齐祥路2779号  
电话: 0533-3595351  
传真: 0533-3595352  
邮编: 255086  
网址: [www.shinvasurgical.com](http://www.shinvasurgical.com)

ADD: No.2779 Qixiang Road, Zibo Hi-tech Zone,  
Shandong Province, China  
TEL: 0533-3595351  
FAX: 0533-3595352  
ZIP: 255086  
<http://www.shinvasurgical.com>