

质量——我们迈向成功之路  
QUALITY - OUR WAY TO SUCCESS

SHINVA 新华医疗  
为健康创新界



SHINVA



# 骨科手术器械

ORTHOPEDIC INSTRUMENTS



地址：山东省淄博市高新区齐祥路2779号  
电话：0533-3595351  
传真：0533-3595352  
邮编：255086  
网址：www.shinvasurgical.com

ADD: No.2779 Qixiang Road, Zibo Hi-tech Zone,  
Shandong Province, China  
TEL: 0533-3595351  
FAX: 0533-3595352  
ZIP: 255086  
http: www.shinvasurgical.com

新华手术器械有限公司  
XINHUA SURGICAL INSTRUMENT CO.,LTD.

\* 2025版, 此样本图片仅供参考, 本公司保留对产品改良设计的变更权, 具体请以产品实物为准\*



---

**SHINVA** 新华手术器械有限公司  
XINHUA SURGICAL INSTRUMENT CO., LTD.

岁月积淀 铸就非凡品质  
YEARS OF ACCUMULATION EXTRAORDINARY CAST QUALITY

---

# 公司简介 Company Profile



新华医疗成立于1943年,是我党我军创建的第一家医疗器械生产企业,手术器械作为新华医疗的起家产品,经过八十余年匠心传承,现已发展为国内手术器械行业领军企业。

新华手术器械有限公司专业从事手术器械的研发、生产和销售,引进国际先进的手术器械制造工艺和装备,拥有一流的手术器械生产线。公司产品涵盖了神经外科、骨科、普外科、心胸外科等临床外科各科室,拥有14000余个品种规格。公司积极布局微创外科领域,先后推出腔镜器械、内窥镜摄像系统、光学硬镜、微创手术耗材等产品,已打造成集手术器械、手术设备、手术耗材、硬质容器四大系列的产品矩阵,满足外科手术“器械+设备+耗材”整体配置需要。

公司通过ISO9001质量体系认证和ISO13485医疗器械质量体系认证,主持和参与起草多项行业标准,产品获得欧盟CE认证和美国FDA认证,远销亚洲、中东、欧美的60多个国家和地区。

公司为国家级高新技术企业、山东省制造业单项冠军企业、山东省“专精特新”企业,拥有省级企业技术中心等技术创新平台,产品制造工艺技术和质量控制水平位居国内前列,表面处理、防腐耐蚀等方面技术能力处于国际先进水平。

我们始终奉行“质量—我们迈向成功之路”的品牌理念,持续走医工结合的创新之路,为各级医疗机构和临床专家提供专业化的解决方案,以满足国内外外科手术快速发展的需要,为人类健康事业做出更大贡献。

Shinya Medical is the first medical device manufacturer set up by our Party and military in 1943 with surgical instruments as the starting product. Now as surgical instrument subsidiary of Shinya Medical, Xinhua Surgical Instrument Co., Ltd., has developed into a leading company in the domestic surgical instrument industry after more than 80 years of production experience.

Specializing in R&D, production and sales of surgical instruments, Xinhua Surgical Instrument Co., Ltd. has first-class production line for surgical instruments with advanced imported manufacturing techniques and machines. Product portfolio covers various clinical departments such as neuro, orthopedics, cardiothoracic and general surgeries etc with over 14,000 varieties and specifications. The company has actively developed minimally invasive surgery items and launched product lines including endoscopic instruments, endoscopic camera systems, endoscopes, and MIS consumables. Now with four product families: surgical instruments, surgical equipment, surgical consumables, and hard containers, the company can meet the overall clinical needs of "instruments + equipment + consumables".

The company has obtained ISO9001 and ISO13485 certificates, organized and participated drafting some industrial standards. Products are certified CE MDR, registered in USFDA and exported to over 60 countries in Asia, the Middle East, Europe and America etc.

The company is rewarded “national high-tech enterprise”, “single champion enterprise in Shandong Province's manufacturing industry”, and “specialized, refined, distinctive and innovative enterprise in Shandong Province” and has a provincial-level technology center and other technical innovation centers. Its manufacturing techniques and quality control are in the top of China, its surface treatment, and corrosion resistance technique are at the international advanced level.

Following our brand principle “Quality - our way to success” all the time and on the way of continuous innovation with clinic support, the company is devoted to supply professional clinical solutions to meet rapid development needs of hospitals and surgeons and devoted greater contribution in the health of human being.



# 目录

## CONTENT

SHINVA

**P01** 内窥镜摄像系统  
Endoscopic Camera System

**P07** 动力系统  
Power Tools

**P21** 运动医学  
Sports Medicine

**P45** 脊柱微创器械  
Minimally invasive spinal Instrument

**P93** 脊柱基础器械  
Spinal basic Instrument

**P123** 椎板咬骨钳  
Kerrison Punch

**P131** 髓核钳  
Laminectomy Rongeur

**P136** 咬骨钳  
Bone Rongeur

**P142** 剥离子/剥离器  
Periosteal Raspatory

**P150** 骨刀/骨凿  
Chisel

**P164** 刮匙  
Bone Curette

**P171** 复位钳/持骨钳  
Reposition Forceps/Bone Clamp

**P184** 剪切和折弯工具  
Cutting and bending tools

**P192** 关节器械  
Joint instruments

**P221** 骨科手术基础器械  
Basic instruments for orthopedic surgery

**P253** 手足器械  
Hand and foot instruments

**P277** 内固定取出器械  
Internal fixation and removal instruments

## 骨科微创4K摄像系统

Orthopedic 4K Camera System



### 多项自研图像处理算法

Intelligent image algorithms

#### 高亮抑制 Anti-overexposure

自动识别过曝区域并进行亮度抑制，使整个手术视野更柔和，缓解视觉疲劳。

Recognize automatically overexposure area and decrease the brightness to achieve homogeneous illumination.



过曝显示  
overexposure

高亮抑制  
anti-overexposure

#### 暗区改善 Dark area improvement

自动识别视野暗区并进行暗区增亮，使整个视野更通透。

Recognize automatically dark area and enhance its visibility.

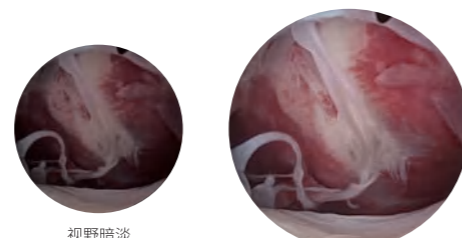

视野暗淡  
dark area

暗区增量  
dark improvement

#### 细节滤镜 Detail filter

突出腔体内血管，医生更清楚分辨细节，降低出血风险。

Highlight the vessels, enabling surgeons to see them clearly.

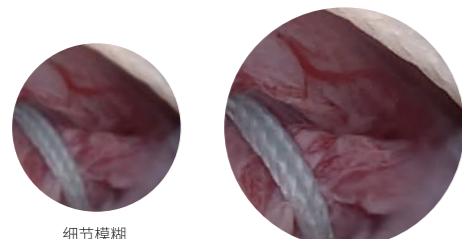

细节模糊  
detail blurred

细节清晰  
detail clear

#### 防红溢出 Anti-red overflow

淡化大面积红色场景的视觉冲击，缓解医生视觉疲劳。

Fade large area blood scene to relieve surgeons visual fatigue.

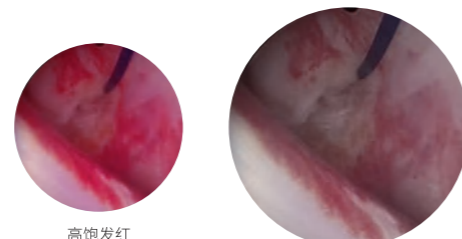

高饱发红  
too red area

淡化防红  
soft red area



### 脊柱内镜推荐配置 / Recommended configuration of spine camera system

产品编码 Article no.	产品名称 Description	规格 Specification	
ZP5003	摄像主机 4K camera control unit	PU-3	
ZP5110	摄像头 4K camera head	CU-2 (手动调焦F14~32) manual focus F14-32	
ZP5307	冷光源 cold light source	L80-1	
ZP5313	导光束 light cable	4mm×3m	
JP4033	脊柱内镜 (单通道专用) spine endoscope (for uniportal)	DS0633001A	
ZP6062	关节内镜 (双通道专用) arthroscope (for biportal)	175×Φ4, 30°	二选一 Alternative
JP6072	关节镜鞘 (双通道专用) arthroscope sheath (for biportal)	175×Φ6	
ZP5528	医用显示器 medical monitor	32寸, 4K 32 inch, 4K	
ZP5105	内窥镜台车 trolley	YB-997T	



关节镜推荐配置 / Recommended configuration of arthroscopic camera system

产品编码 Article no.	产品名称 Description	规格 Specification
ZP5003	摄像主机 4K camera control unit	PU-3
ZP5110	摄像头 4K camera head	CU-2(手动调焦F14~32) manual focus F14-32
ZP5307	冷光源 cold light source	L80-1
ZP5313	导光束 light cable	4mm×3m
ZP6062	关节内窥镜 arthroscope	175×Φ4, 30°
JP6072	关节镜鞘 sheath	175×Φ6
ZP6084	闭孔器 obturator	175×Φ4.2, 钝头 blunt tip
ZP5528	医用显示器 medical monitor	32寸、4K 32 inch,4K
ZP5105	内窥镜台车 trolley	YB-997T



关节内窥镜 / Arthroscope



产品编码 article no.	规格 specification	内镜直径 scope diameter	工作长度 working length	视野方向 vision angle
JP6051	110×φ2.7,0°	2.7mm	110mm	0°
JP6052	110×φ2.7,30°	2.7mm	110mm	30°
JP6053	110×φ2.7,70°	2.7mm	110mm	70°
JP6061	175×φ4,0°	4mm	175mm	0°
JP6062	175×φ4,30°	4mm	175mm	30°
JP6063	175×φ4,70°	4mm	175mm	70°
ZP6061	175×φ4,0°	4mm	175mm	0°
ZP6062	175×φ4,30°	4mm	175mm	30°
ZP6063	175×φ4,70°	4mm	175mm	70°

镜鞘 / Sheath



产品编码 article no.	规格 specification	适配关节镜外径 for arthroscope dia.
JP6071	110×φ3.8	φ2.7
JP6072	175×φ6	φ4 (0°, 30°)
ZP6072	175×φ6	φ4 (0°, 30°)
ZP6073	175×φ6	φ4, 70°

闭孔器 / Obturator



产品编码 article no.	规格 specification	适配镜鞘外径 for sheath dia.
ZP6081	110×φ2.7, 尖头 sharp tip	φ3.8
ZP6082	110×φ2.7, 钝头 blunt tip	φ3.8
ZP6083	175×φ4.2, 尖头 sharp tip	φ6
ZP6084	175×φ4.2, 钝头 blunt tip	φ6

脊柱内窥镜 / Spinal endoscope



编码 article no.	视向角 / (°) direction of view	视场角 / (°) field of view	工作长度 working Length	插入部最大宽度 max.sleeve width	器械通道最小宽度 min.width of instrument channel	灌流通道最小宽度 min.width of irrigation channel
JP4033	30°	80°	181mm	6.3mm	3.7mm	1.5mm
JP4034	30°	80°	181mm	6.9mm	4.3mm	1.5mm
JP4036	15°	80°	125mm	10.0mm	7.1mm	1.7mm

### XGZ-ZX 型/骨组织手术设备

XGZ-ZX Electric Orthopedic System for Neuro Surgery



自停钻头  
Self-stop drill



HD02001低速型手机  
HD02001 low speed handpiece



HD03019直机头  
HD03019 straight attachment



HD03009铣机头  
HD03009 milling attachment

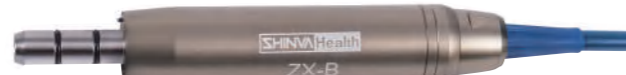

HD02005高速型A手机  
HD02005 high speed handpiece

#### ● 临床应用 Application

适用于神经外科手术中对脑外伤、脑出血、肿瘤及神经功能性病变等手术，或用于经鼻入颅手术中颅内/颅底骨组织和软组织的精细磨削。

Applicable for delicate drilling, milling and grinding in neuro surgeries such as brain injury, bleeding, tumors or neuro functional diseases; or endonasal skull base surgeries.

#### ● 产品特性 Features

高效开颅: 开颅铣转速70000rpm, 1:1速率输出, 高扭高转速;  
性能稳定: 全密封进口电机, 功率150W+, 可承受1000次灭菌循环;  
保障安全: 开机自我故障诊断, 故障自动停机并发出警报;  
操作舒适: 无风冷隔热设计, 连续运行10min表面温升不超过15°C;  
智能补偿: 恒输出控制, 具有功率补偿功能, 负载掉速≤5%。

High efficiency craniotomy: 70000rpm, 1:1 output, high torque and high rotation;  
High quality: Fully sealed imported motor, 150W+ power and can be at least 1000 times sterilized;  
Automatic trouble shooting: automatic trouble shooting when power on and automatic stop as soon as trouble occurs and alarms at the same time;  
Comfortable operation: no air cooling and heat proof design, temperature increases less than 15 with 15-minute continuous running;  
Intelligent power compensation: constant power output with automatic power compensation, loading speed decrease < 5%.

#### ● 技术参数 Technical specification

产品编码 Article NO.	HD01002	
电源 Power	AC 220V, 50Hz	
最高输出转速 Max. output rotation	低速型手机 low speed handpiece	1400 rpm
	高速型A手机 high speed handpiece	70000 rpm
输出转矩 Output torque	低速型手机 low speed handpiece	≥750mN.m
	高速型A手机 high speed handpiece	≥11.2 mN.m
调速范围 Speed adjustment	三档可调, 无级变速 three speed options, stepless adjustment	
设备功率 Output	300VA	

### XGZ-ZJ 型/骨组织手术设备

XGZ-ZJ Electric Orthopedic System for Spine, Maxillofacial, Hand and Foot Surgeries



HD02002普通型手机  
HD02002 normal handpiece



HD02004高速型手机  
HD02004 high speed handpiece



HD03001往复锯机头  
HD03001 reciprocating saw attachment



HD03002摆锯机头  
HD03002 oscillating saw attachment



HD03019直机头  
HD03019 straight attachment

#### ● 临床应用 Application

适用于骨科、颌面外科、手足等科室的手术操作; 可用于椎间孔镜、椎间盘镜等手术; 或用于单侧双通道脊柱微创手术及开放式脊柱外科手术。同时适用于颌面外科、整形外科或其他相关外科手术中对人体上颌、下颌、颧骨等骨组织的钻削、铣削、锯切、磨削处理。

Applicable for orthopedic, maxillofacial, hand and foot, open and endoscopic spine surgeries.

#### ● 产品特性 Features

精细手术: 采用0.35mm高强度锯片, 可以满足各类手术最大程度减小骨缝的需求;  
适用性强: 宽电压设计, 脚踏达到IPX8防水等级;  
高效工作: 动力强劲、恒输出控制, 负载掉速≤5%、ISO-E型快换接口;  
智能自检: 自我故障诊断, 一旦故障自动急停并发出警报;

Delicate cutting: minimize injury with only 0.35mm strong saw blade;  
Good applicability: wide voltage design with IPX8 water proof foot switch;  
High efficiency: constant and strong output control with loading speed decrease < 5%, ISO-E quick coupling connection;  
Intelligent trouble shooting: automatic trouble shooting and automatic stop as soon as trouble occurs and alarms at the same time.

#### ● 技术参数 Technical specification

产品编码 Article NO.	HD01003	
电源 Power	AC 220V, 50Hz	
最高输出转速 Max. output rotation	普通型手机 Normal handpiece	30000 rpm
	往复锯机头 Reciprocating saw attachment	30000 rpm
	摆锯机头 Oscillating saw attachment	20000 rpm
	立摆锯机头 Oscillating saw attachment	20000 rpm
输出转矩 Output torque	高速型手机 High speed handpiece	70000 rpm
	普通型手机 Normal handpiece	≥14.4mN.m
调速范围 Speed adjustment	高速型手机 High speed handpiece	≥7.4 mN.m
	三档可调, 无级变速 three speed options, stepless adjustment	
设备功率 Output	180VA	

### XGZ-N-I 型/骨组织手术设备

XGZ-N-I Electric Orthopedic System



**HD04001-01 多功能主机 (最高转速:80000rpm)**  
(下方产品可选配) following products optional

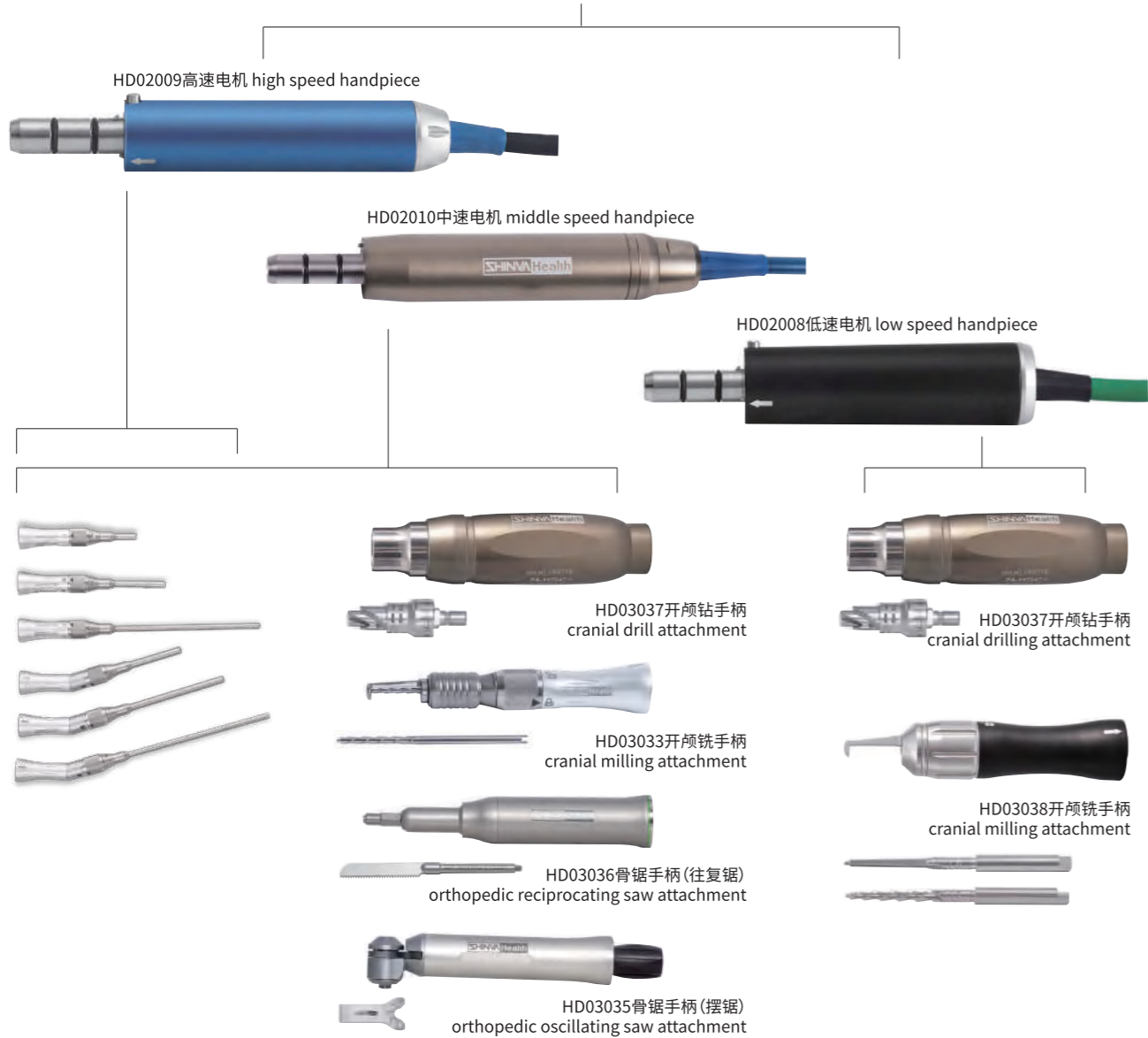

### 刀具及附件

Cutting Tools and Attachments

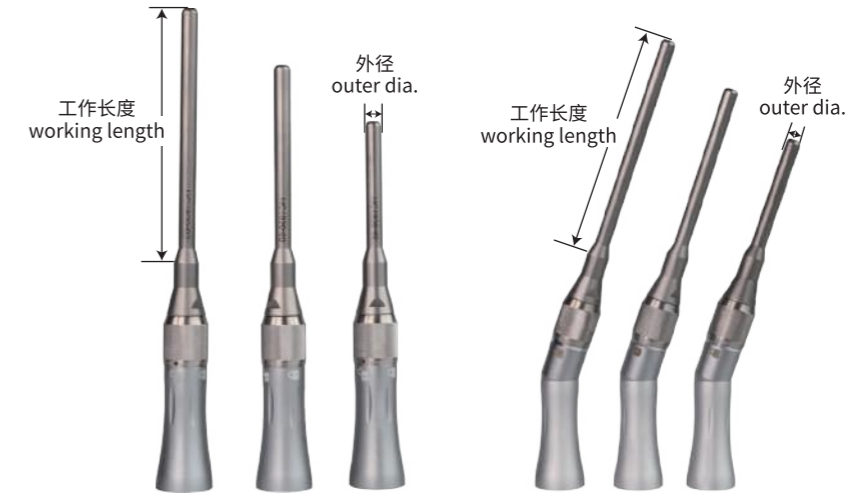

磨柄机头 (适用于高速A手机、高速型手机) / 规格参数

For high speed A handpiece, other high speed handpieces/Attachments Specification

产品编码 Article NO.	产品名称 Products	工作长度 (mm) Working length	外径 (mm) Outer Dia.	内径 (mm) Inner Dia.	适用范围 Applicable Surgery
★ HD03034	直机头 straight attachment	20	6	2.35	开放性手术 for open surgeries
HD03004	直机头 straight attachment	30	6	2.35	
HD03005	弯机头 curved attachment				
★ HD03019	直机头 straight attachment	45	6	2.35	
HD03022	弯机头 curved attachment				
HD03020	直机头 straight attachment	65	6	2.35	
HD03023	弯机头 curved attachment				
HD03021	直机头 straight attachment	85	6	2.35	
★ HD03024	弯机头 curved attachment				
HD03025	长直机头 long straight attachment	88	5	2	
HD03026	长弯机头 long curved attachment				
HD03027	长直机头 long straight attachment	108	5	2	
HD03028	长弯机头 long curved attachment				
HD03029	长直机头 long straight attachment	128	5	2	
HD03030	长弯机头 long curved attachment				
★ HD03031	超长直机头 super long straight attachment	300	3.5	2	镜下脊柱 for endoscopic spine surgeries
HD03032	超长弯机头 super long curved attachment				

刀具及附件

Cutting Tools and Attachments



球状切削钻 / 规格参数  
Burrs/specification

产品编码 Article NO.	型号 Specification	直径 (mm) Dia.	长度 (mm) Length	适配磨柄 Applicable attachment
HD09056-40	QZ10060	φ1	60	HD03034
HD09056-41	QZ20060	φ2	60	
HD09056-42	QZ30060	φ3	60	
HD09056-43	QZ40060	φ4	60	
HD09056-44	QZ50060	φ5	60	
HD09056-45	QZ60060	φ6	60	
HD09001	QZ10070	φ1	70	HD03004 HD03005
HD09002	QZ20070	φ2	70	
HD09003	QZ30070	φ3	70	
HD09004	QZ40070	φ4	70	
HD09005	QZ50070	φ5	70	
HD09056-11	QZ10085	φ1	85	HD03019 HD03022
★ HD09056-12	QZ20085	φ2	85	
★ HD09056-13	QZ30085	φ3	85	
★ HD09056-14	QZ40085	φ4	85	
HD09056-15	QZ50085	φ5	85	
HD09056-16	QZ60085	φ6	85	
HD09056-17	QZ10125	φ1	125	HD03021 HD03024
★ HD09056-18	QZ20125	φ2	125	
★ HD09056-19	QZ30125	φ3	125	
★ HD09056-20	QZ40125	φ4	125	
HD09056-21	QZ50125	φ5	125	
HD09056-22	QZ60125	φ6	125	
HD09056-23	QZ10105	φ1	105	HD03020 HD03023
HD09056-24	QZ20105	φ2	105	
HD09056-25	QZ30105	φ3	105	
HD09056-26	QZ40105	φ4	105	
HD09056-27	QZ50105	φ5	105	
HD09056-28	QZ60105	φ6	105	
HD09056-29	QZ20128	φ2	128	HD03025 HD03026
HD09056-30	QZ30128	φ3	128	
HD09056-31	QZ40128	φ4	128	
HD09056-32	QZ20148	φ2	148	HD03027 HD03028
HD09056-33	QZ30148	φ3	148	
HD09056-34	QZ40148	φ4	148	
HD09056-35	QZ20168	φ2	168	HD03029 HD03030
HD09056-36	QZ30168	φ3	168	
HD09056-37	QZ40168	φ4	168	
★ HD09056-38	QZ30330	φ3	330	HD03031 HD03032
★ HD09056-39	QZ40330	φ4	330	

刀具及附件

Cutting Tools and Attachments

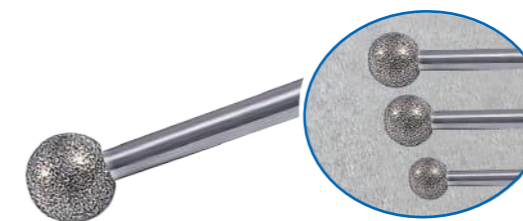

磨头 (金刚砂磨头) / 规格参数  
Diamond dust coated burrs/specification

产品编码 Article NO.	型号 Specification	直径 (mm) Dia.	长度 (mm) Length	适配磨柄 Applicable attachment
HD09054-70	QM10060	φ1	60	HD03034
HD09054-71	QM20060	φ2	60	
HD09054-72	QM30060	φ3	60	
HD09054-73	QM40060	φ4	60	
HD09054-74	QM50060	φ5	60	
HD09054-75	QM60060	φ6	60	
HD09054-01	QM10070	φ1	70	HD03004 HD03005
HD09054-03	QM20070	φ2	70	
HD09054-05	QM30070	φ3	70	
HD09054-10	QM40070	φ4	70	
HD09054-15	QM50070	φ5	70	
HD09054-41	QM10085	φ1	85	HD03019 HD03022
★ HD09054-42	QM20085	φ2	85	
★ HD09054-43	QM30085	φ3	85	
★ HD09054-44	QM40085	φ4	85	
HD09054-45	QM50085	φ5	85	
HD09054-46	QM60085	φ6	85	
HD09054-47	QM10125	φ1	125	HD03021 HD03024
★ HD09054-48	QM20125	φ2	125	
★ HD09054-49	QM30125	φ3	125	
★ HD09054-50	QM40125	φ4	125	
HD09054-51	QM50125	φ5	125	
HD09054-52	QM60125	φ6	125	
HD09054-53	QM10105	φ1	105	HD03020 HD03023
HD09054-54	QM20105	φ2	105	
HD09054-55	QM30105	φ3	105	
HD09054-56	QM40105	φ4	105	
HD09054-57	QM50105	φ5	105	
HD09054-58	QM60105	φ6	105	
HD09054-59	QM20128	φ2	128	HD03025 HD03026
HD09054-60	QM30128	φ3	128	
HD09054-61	QM40128	φ4	128	
HD09054-62	QM20148	φ2	148	HD03027 HD03028
HD09054-63	QM30148	φ3	148	
HD09054-64	QM40148	φ4	148	
HD09054-65	QM20168	φ2	168	HD03029 HD03030
HD09054-66	QM30168	φ3	168	
HD09054-67	QM40168	φ4	168	
★ HD09054-68	QM30330	φ3	330	HD03031 HD03032
★ HD09054-69	QM40330	φ4	330	

刀具及附件

Cutting Tools and Attachments



往复锯机头 / 规格参数  
Reciprocating saw attachment/specification

产品编码 Article No.	产品名称 Product	型号 Specification	往复频率 Working Speed	往复冲程 Working Distance
HD03001	往复锯机头	WFJT	30000cpm	1.8mm



摆锯机头 / 规格参数  
Oscillating saw attachment/specification

产品编码 Article No.	产品名称 Product	型号 Specification	摆频 Working Speed	摆幅 Working angle
HD03002	摆锯机头	BJJT	20000cpm	3°



麻花钻 / 规格参数  
Twist Drills/specification

产品编码 Article No.	麻花直径 d1 (mm)	长度 L (mm)	适配机头 Applicable attachments
HD09011	φ1.2	80	HD03004
HD09012	φ1.5	80	HD03005
★ HD09055-05	φ1.1	70	HD03034
★ HD09055-06	φ1.5	70	
★ HD09055-07	φ2.0	70	



自停钻头 / 规格参数  
Self-stop Drills/specification

产品编码 Article No.	规格 Specification
HD09059	φ7
HD09060	φ9
HD09024	φ11



往复锯片 / 规格参数  
Reciprocating saw blade/specification

产品编码 Article No.	总长度 (mm) Total Length	锯片厚度 (mm) Blade thickness	齿部长度 (mm) Working Length	齿部宽度 (mm) Blade Width
HD09061-06	48	0.5	22	4



平摆锯片 / 规格参数  
Oscillating saw blade/specification

产品编码 Article No.	总长度 (mm) Total Length	锯片厚度 (mm) Blade thickness	齿部宽度 (mm) Blade Width
HD09062-03	20	0.4	4
HD09062-04	22	0.4	6
HD09062-05	24	0.4	8
HD09062-06	26	0.4	10
HD09062-07	31	0.5	9
HD09062-08	50	0.5	10



铣刀 / 规格参数  
Milling Cutter/specification

产品编码 Article No.	刃部直径 Blade diameter	杆部直径 Rod diameter	刃型 Blade shape
HD09014-11	φ2.2	φ2.35	螺旋
HD09014-12	φ1.8	φ3.0	螺旋
HD09014-13	φ1.8	φ3.0	直刃

电池供电骨科手术设备

Battery Operated Orthopedic Power Tools



XGZ-DZ- I  
骨钻  
BONE DRILL

适用于创伤手术  
Apply to trauma operation

产品编码 Article No.	HD10001	转速 Speed	0-1100rpm	输出功率 Output power	150W
适用于134°C高温蒸汽灭菌 It is suitable for high temperature steam sterilization at 134 °C					



XGZ-DZ- II  
开颅钻  
CRANIOTOMY  
DRILL

适用于神外手术  
Apply to neurosurgery

产品编码 Article No.	HD10002	转速 Speed	0-1000rpm	输出功率 Output power	150W
适用于134°C高温蒸汽灭菌 It is suitable for high temperature steam sterilization at 134 °C					



XGZ-DZ- III  
研磨钻  
HIGH TORQUE  
HIP JOINT DRILL

适用于关节手术  
Apply to joint operation

产品编码 Article No.	HD10003	转速 Speed	0-350rpm	输出功率 Output power	150W
适用于134°C高温蒸汽灭菌 It is suitable for high temperature steam sterilization at 134 °C					



XGZ-DJ- I  
摆锯  
OSCILLATING SAW

适用于关节手术  
Apply to joint operation

产品编码 Article No.	HD10004	转速 Speed	0-18000cpm	输出功率 Output power	150W
适用于134°C高温蒸汽灭菌 It is suitable for high temperature steam sterilization at 134 °C					

电池供电骨科手术设备

Battery Operated Orthopedic Power Tools



**XGZ-DJ- III**  
往复锯  
**RECIPROCATING SAW**

适用于关节手术  
Apply to joint operation

产品编码 Article No.	HD10005	转速 Speed	0-12500cpm	输出功率 Output power	150W
适用于134°C高温蒸汽灭菌 It is suitable for high temperature steam sterilization at 134 °C					



**XGZ-DZ- IV**  
空心钻  
**CANNULATED DRILL**

适用于创伤手术  
Apply to trauma operation

产品编码 Article No.	HD10008	转速 Speed	0-1100rpm	输出功率 Output power	150W
适用于134°C高温蒸汽灭菌 It is suitable for high temperature steam sterilization at 134 °C					



**XGZ-DJ- III**  
胸骨锯  
**STERNUM SAW**

适用于心胸手术  
Apply to thoracotomy

产品编码 Article No.	HD10009	转速 Speed	0-12500cpm	输出功率 Output power	150W
适用于134°C高温蒸汽灭菌 It is suitable for high temperature steam sterilization at 134 °C					



**XGZ-DZ-V**  
开颅铣  
**CRANIOTOMY MILL**

适用于神外手术  
Apply to neurosurgery

产品编码 Article No.	HD10026	转速 Speed	0-4000rpm	输出功率 Output power	150W
适用于134°C高温蒸汽灭菌 It is suitable for high temperature steam sterilization at 134 °C					

**XGZ-DT- I 多功能钻铣锯**  
**MULTIFUNCTIONAL POWER TOOLS**

产品编码 Article No.	HD10006	适用于神外手术、创伤手术、心胸手术、关节手术 Apply to neurosurgery, trauma operation , thoracotomy, joint operation
---------------------	---------	--

配件 ACCESSORIES

产品编码 Article No.	HD10021
转速 Speed	0-13500rpm
输出功率 Output power	150W

适用于134°C高温蒸汽灭菌

It is suitable for high temperature steam sterilization at 134 °C



名称 Component name	骨钻组件 Bone drill component
夹持范围 Gripping range	0.8-7.9mm
转速/摆频 Speed	0-850rpm

产品编码Article No. HD10006-02



名称 Component name	摆锯组件 Oscillating saw component
夹持范围 Gripping range	/
转速/摆频 Speed	0-13500cpm

产品编码Article No. HD10006-03



名称 Component name	研磨钻组件 Hip joint drill component
夹持范围 Gripping range	1.0-8.1mm
转速/摆频 Speed	0-210rpm

产品编码Article No. HD10006-04



名称 Component name	空心钻组件 Cannulated drill component	产品编码Article No. HD10006-05 
夹持范围 Gripping range	0.8-7.9mm	
转速/摆频 Speed	0-450rpm	

名称 Component name	开颅钻组件 Cranial drill component	产品编码Article No. HD10006-06 
夹持范围 Gripping range	/	
转速/摆频 Speed	0-850rpm	

名称 Component name	开颅铣组件 Cranial mill component	产品编码Article No. HD10006-07 
夹持范围 Gripping range	/	
转速/摆频 Speed	0-30000rpm	

名称 Component name	往复锯组件 Reciprocating saw component	产品编码Article No. HD10006-08 
夹持范围 Gripping range	/	
转速/摆频 Speed	0-13000cpm	

名称 Component name	HD10006-18	HD10006-19	名称 Component name	快夹空心钻组件 Quick clamping Cannulated drill component
夹持范围 Gripping range	0.8-2.0mm	1.5-3.2mm		
转速/摆频 Speed	0-1200rpm			

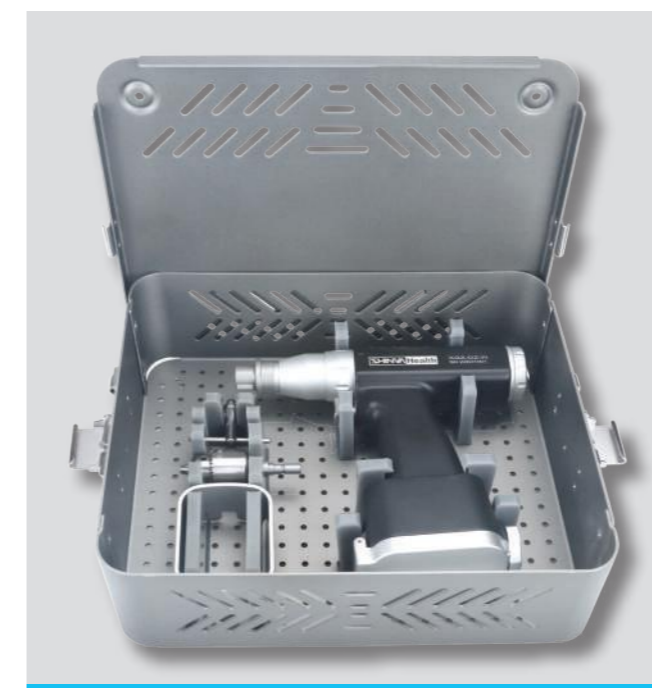

■ 器材消毒箱 / Sterilization case	
产品编码 Article No.	HD10001-14

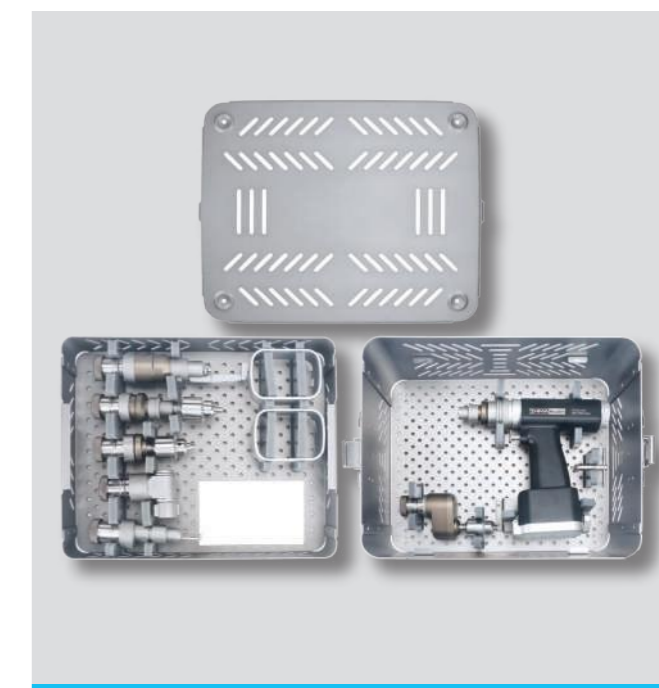

■ 器材消毒箱 / Sterilization case	
产品编码 Article No.	HD10006-12

配件 ACCESSORIES



■ 电池 / Battery	
产品编码 Article No.	HD10001-05



■ 充电器 / Charger	
产品编码 Article No.	HD10001-06



■ 钥匙 / Key for drill chuck	
产品编码 Article No.	HD10001-11



■ 消毒通道 / Sterile cover	
产品编码 Article No.	HD10001-07

电池供电骨组织手术设备

Battery Operated Orthopedic Power Tools



■ 自停钻 Self-stop drills			
产品编码 Article No.	HD10002-11-01	规格 Specifications	XH Cr $\phi$ 8
	HD10002-11-02		XH Cr $\phi$ 9
	HD10002-11-03		XH Cr $\phi$ 10
	HD10002-11-04		XH Cr $\phi$ 11



■ 摆锯片 Oscillating saw blade			
产品编码 Article No.	HD10004-11-01	规格 Specifications	XH Cr 118×13×1
	HD10004-11-03		XHCr 118×13×1.2

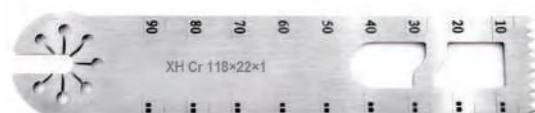

■ 摆锯片 Oscillating saw blade			
产品编码 Article No.	HD10004-11-02	规格 Specifications	XH Cr 118×22×1
	HD10004-11-04		XHCr 118×22×1.2

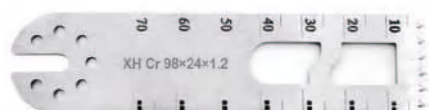

■ 摆锯片 Oscillating saw blade			
产品编码 Article No.	HD10004-11-05	规格 Specifications	XH Cr 98×24×1.2



■ 摆锯片 Oscillating saw blade			
产品编码 Article No.	HD10004-11-06	规格 Specifications	XH Cr 73×32×1.2



■ 胸骨锯锯片 Sternum saw blade			
产品编码 Article No.	HD10005-11	规格 Specifications	XH Cr 60×7.2×0.8



■ 往复锯双面齿 Reciprocating saw blade			
产品编码 Article No.	HD10005-12	规格 Specifications	XH Cr 92×13.4×0.8



■ 往复锯单面齿 Reciprocating saw blade			
产品编码 Article No.	HD10005-13	规格 Specifications	XH Cr 106×11.9×0.8



■ 牙刷锯片 Reciprocating saw blade			
产品编码 Article No.	HD10005-14	规格 Specifications	XH Cr 110×3.3×0.8



■ 铣刀 Milling cutter			
产品编码 Article No.	HD10006-09-01	规格 Specifications	XH Cr 69.5×2.5× $\phi$ 3

篮钳  
Basket Forceps

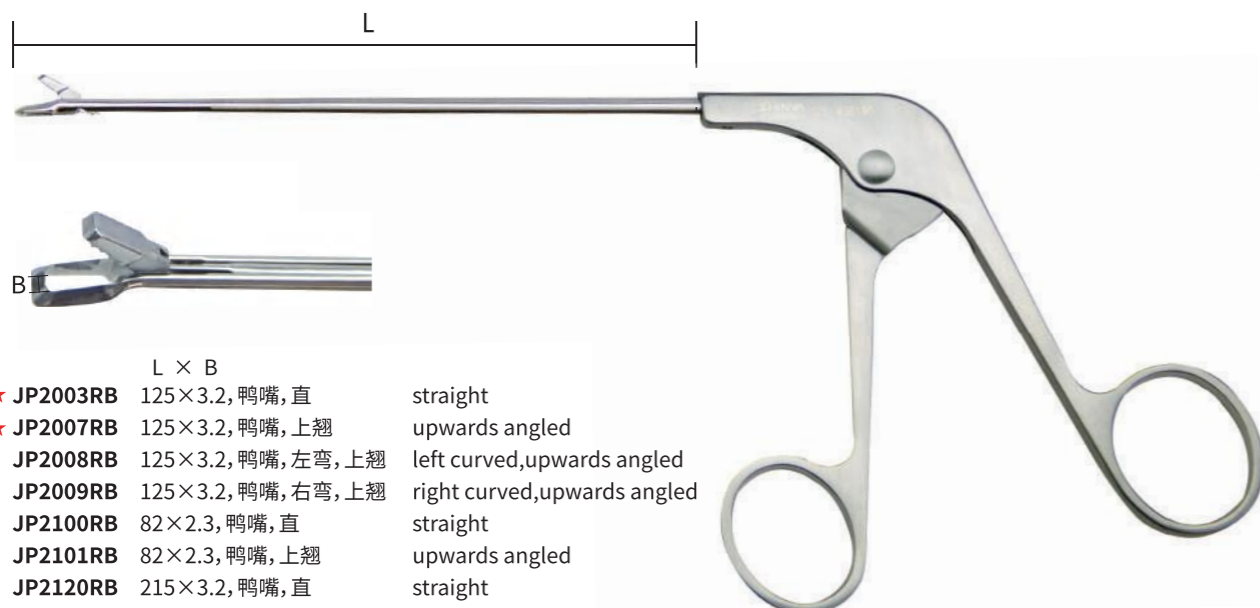

	L × B		
★ JP2003RB	125×3.2, 鸭嘴, 直	straight	
★ JP2007RB	125×3.2, 鸭嘴, 上翘	upwards angled	
JP2008RB	125×3.2, 鸭嘴, 左弯, 上翘	left curved, upwards angled	
JP2009RB	125×3.2, 鸭嘴, 右弯, 上翘	right curved, upwards angled	
JP2100RB	82×2.3, 鸭嘴, 直	straight	
JP2101RB	82×2.3, 鸭嘴, 上翘	upwards angled	
JP2120RB	215×3.2, 鸭嘴, 直	straight	
JP2121RB	215×3.2, 鸭嘴, 上翘	upwards angled	
JP2124RB	215×3.2, 鸭嘴, 上弯	upwards curved	

	L × B		
★ ZP2003RB	125×3.2, 鸭嘴, 直	straight	
★ ZP2007RB	125×3.2, 鸭嘴, 上翘	upwards angled	
ZP2008RB	125×3.2, 鸭嘴, 左弯, 上翘	left curved, upwards angled	
ZP2009RB	125×3.2, 鸭嘴, 右弯, 上翘	right curved, upwards angled	
ZP2100RB	82×2.3, 鸭嘴, 直	straight	
ZP2101RB	82×2.3, 鸭嘴, 上翘	upwards angled	
ZP2120RB	215×3.2, 鸭嘴, 直	straight	
ZP2121RB	215×3.2, 鸭嘴, 上翘	upwards angled	
ZP2124RB	215×3.2, 鸭嘴, 上弯	upwards curved	



★ JP2020RB	125×3.2, 鸭嘴, 直	straight	★ ZP2020RB	125×3.2, 鸭嘴, 直	straight
★ JP2021RB	125×3.2, 鸭嘴, 左弯	left curved	★ ZP2021RB	125×3.2, 鸭嘴, 左弯	left curved
★ JP2022RB	125×3.2, 鸭嘴, 右弯	right curved	★ ZP2022RB	125×3.2, 鸭嘴, 右弯	right curved
★ JP2023RB	125×3.2, 鸭嘴, 上弯	upwards curved	★ ZP2023RB	125×3.2, 鸭嘴, 上弯	upwards curved



★ JP2038RB	125×4.4, 卵圆形, 直	straight
JP2039RB	125×4.4, 卵圆形, 左弯	left curved
JP2040RB	125×4.4, 卵圆形, 右弯	right curved
JP2042RB	125×4.4, 卵圆形, 上翘	upwards angled
JP2105RB	82×2.3, 卵圆形, 直	straight
JP2106RB	82×2.3, 卵圆形, 左弯	left curved
JP2107RB	82×2.3, 卵圆形, 右弯	right curved

★ ZP2038RB	125×4.4, 卵圆形, 直	straight
ZP2039RB	125×4.4, 卵圆形, 左弯	left curved
ZP2040RB	125×4.4, 卵圆形, 右弯	right curved
ZP2042RB	125×4.4, 卵圆形, 上翘	upwards angled
ZP2105RB	82×2.3, 卵圆形, 直	straight
ZP2106RB	82×2.3, 卵圆形, 左弯	left curved
ZP2107RB	82×2.3, 卵圆形, 右弯	right curved



JP2050RB	125×1.8, 窄形, 上翘	upwards angled
JP2058RB	125×1.8, 窄形, 直	straight
JP2059RB	125×1.8, 窄形, 上翘	upwards angled
JP2110RB	82×1.8, 窄形, 直	straight
JP2127RB	215×1.8, 窄形, 直	straight
JP2128RB	215×1.8, 窄形, 上翘	upwards angled

ZP2050RB	125×1.8, 窄形, 上翘	upwards angled
ZP2058RB	125×1.8, 窄形, 直	straight
ZP2059RB	125×1.8, 窄形, 上翘	upwards angled
ZP2110RB	82×1.8, 窄形, 直	straight
ZP2127RB	215×1.8, 窄形, 直	straight
ZP2128RB	215×1.8, 窄形, 上翘	upwards angled



★ JP2074RB	115×2.2, 反咬切, 左	left
★ JP2075RB	115×2.2, 反咬切, 右	right
JP2132RB	210×2.2, 反咬切, 左	left
JP2133RB	210×2.2, 反咬切, 右	right

★ ZP2074RB	115×2.2, 反咬切, 左	left
★ ZP2075RB	115×2.2, 反咬切, 右	right
ZP2132RB	210×2.2, 反咬切, 左	left
ZP2133RB	210×2.2, 反咬切, 右	right



JP2031RB	125×1.8, 窄形, 直	straight
JP2071RB	125×2.2, 窄形, 上翘	upwards angled
ZP2031RB	125×1.8, 窄形, 直	straight
ZP2071RB	125×2.2, 窄形, 上翘	upwards angled

注: 上述“左弯”、“右弯”为杆部左弯或右弯 12°; “上弯”为杆部上弯 15°; “上翘”为头部上翘 20°  
Remark: Above left or right curved means shaft left or right curved to 12°; Upwards curved means shaft upwards curved to 15°; Upwards angled means tip upwards angled to 20°.

篮钳  
Basket Forceps

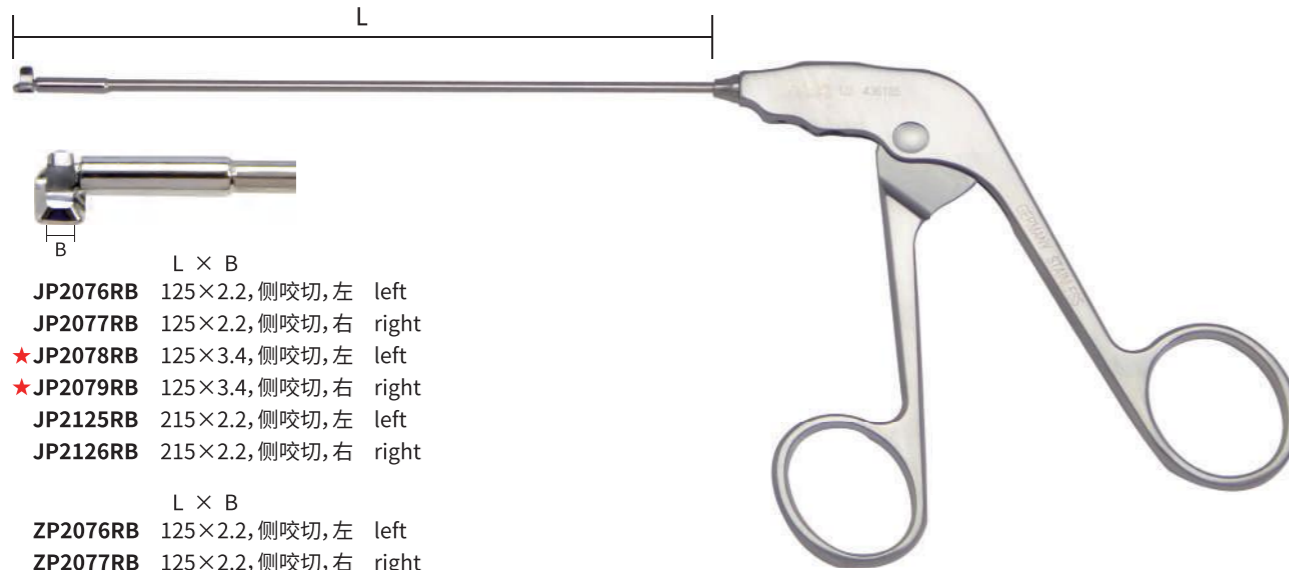

- |           |                 |       |  |
|-----------|-----------------|-------|--|
|           | L × B           |       |  |
| JP2076RB  | 125×2.2, 侧咬切, 左 | left  |  |
| JP2077RB  | 125×2.2, 侧咬切, 右 | right |  |
| ★JP2078RB | 125×3.4, 侧咬切, 左 | left  |  |
| ★JP2079RB | 125×3.4, 侧咬切, 右 | right |  |
| JP2125RB  | 215×2.2, 侧咬切, 左 | left  |  |
| JP2126RB  | 215×2.2, 侧咬切, 右 | right |  |
|           | L × B           |       |  |
| ZP2076RB  | 125×2.2, 侧咬切, 左 | left  |  |
| ZP2077RB  | 125×2.2, 侧咬切, 右 | right |  |
| ★ZP2078RB | 125×3.4, 侧咬切, 左 | left  |  |
| ★ZP2079RB | 125×3.4, 侧咬切, 右 | right |  |
| ZP2125RB  | 215×2.2, 侧咬切, 左 | left  |  |
| ZP2126RB  | 215×2.2, 侧咬切, 右 | right |  |

抓钳  
Grasping Forceps

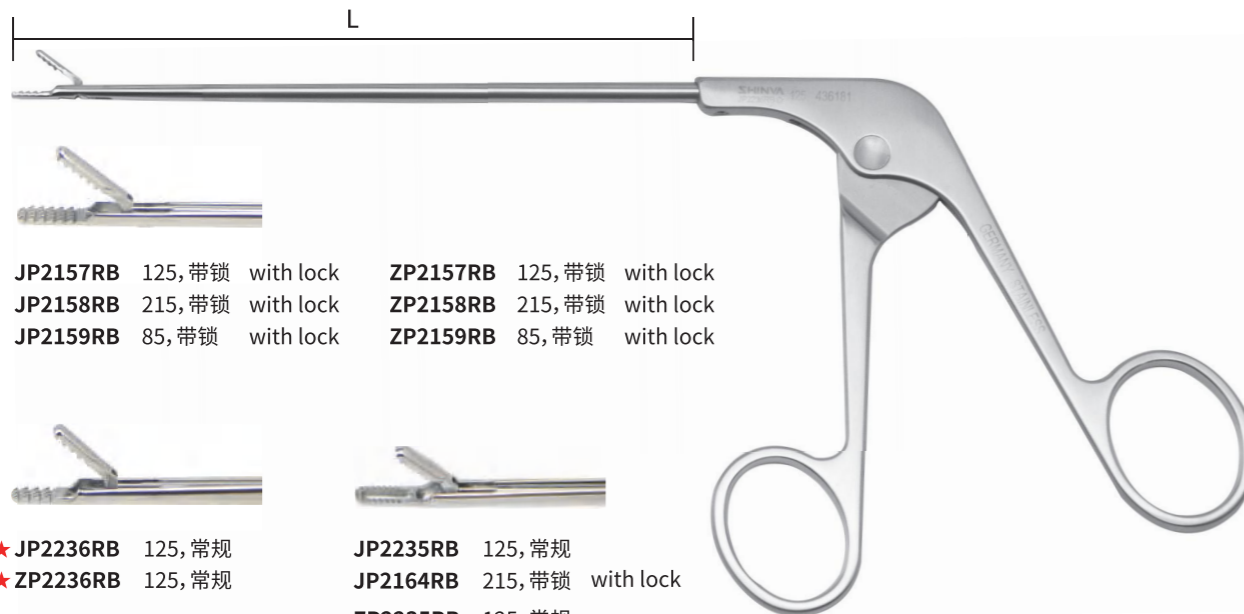

- |           |         |           |          |         |           |
|-----------|---------|-----------|----------|---------|-----------|
| JP2157RB  | 125, 带锁 | with lock | ZP2157RB | 125, 带锁 | with lock |
| JP2158RB  | 215, 带锁 | with lock | ZP2158RB | 215, 带锁 | with lock |
| JP2159RB  | 85, 带锁  | with lock | ZP2159RB | 85, 带锁  | with lock |
| ★JP2236RB | 125, 常规 |           | JP2235RB | 125, 常规 |           |
| ★ZP2236RB | 125, 常规 |           | JP2164RB | 215, 带锁 | with lock |
|           |         |           | ZP2235RB | 125, 常规 |           |
|           |         |           | ZP2164RB | 215, 带锁 | with lock |

穿线钳  
Suture Forceps

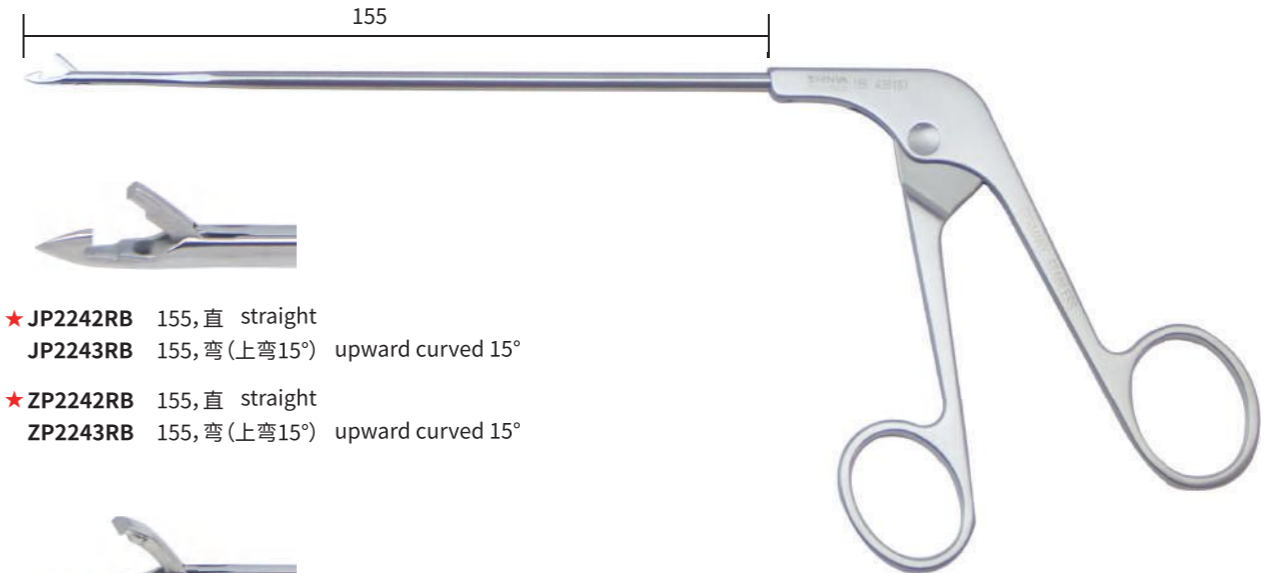

- |           |               |                   |  |
|-----------|---------------|-------------------|--|
| ★JP2242RB | 155, 直        | straight          |  |
| JP2243RB  | 155, 弯(上弯15°) | upward curved 15° |  |
| ★ZP2242RB | 155, 直        | straight          |  |
| ZP2243RB  | 155, 弯(上弯15°) | upward curved 15° |  |
| ★JP2244RB | 155, 弯(左弯45°) | left curved 45°   |  |
| ★JP2245RB | 155, 弯(右弯45°) | right curved 45°  |  |
| ★ZP2244RB | 155, 弯(左弯45°) | left curved 45°   |  |
| ★ZP2245RB | 155, 弯(右弯45°) | right curved 45°  |  |



- |          |               |                   |
|----------|---------------|-------------------|
| JP2246RB | 155, 弯(上翘20°) | upward angled 20° |
| JP2247RB | 155, 弯(上翘40°) | upward angled 40° |
| ZP2246RB | 155, 弯(上翘20°) | upward angled 20° |
| ZP2247RB | 155, 弯(上翘40°) | upward angled 40° |



- |          |                  |                                |
|----------|------------------|--------------------------------|
| JP2248RB | 155, 弯(左弯45°下开口) | left curved 45°, down opening  |
| JP2249RB | 155, 弯(右弯45°下开口) | right curved 45°, down opening |
| ZP2248RB | 155, 弯(左弯45°下开口) | left curved 45°, down opening  |
| ZP2249RB | 155, 弯(右弯45°下开口) | right curved 45°, down opening |

抓线器  
Suture Grasper

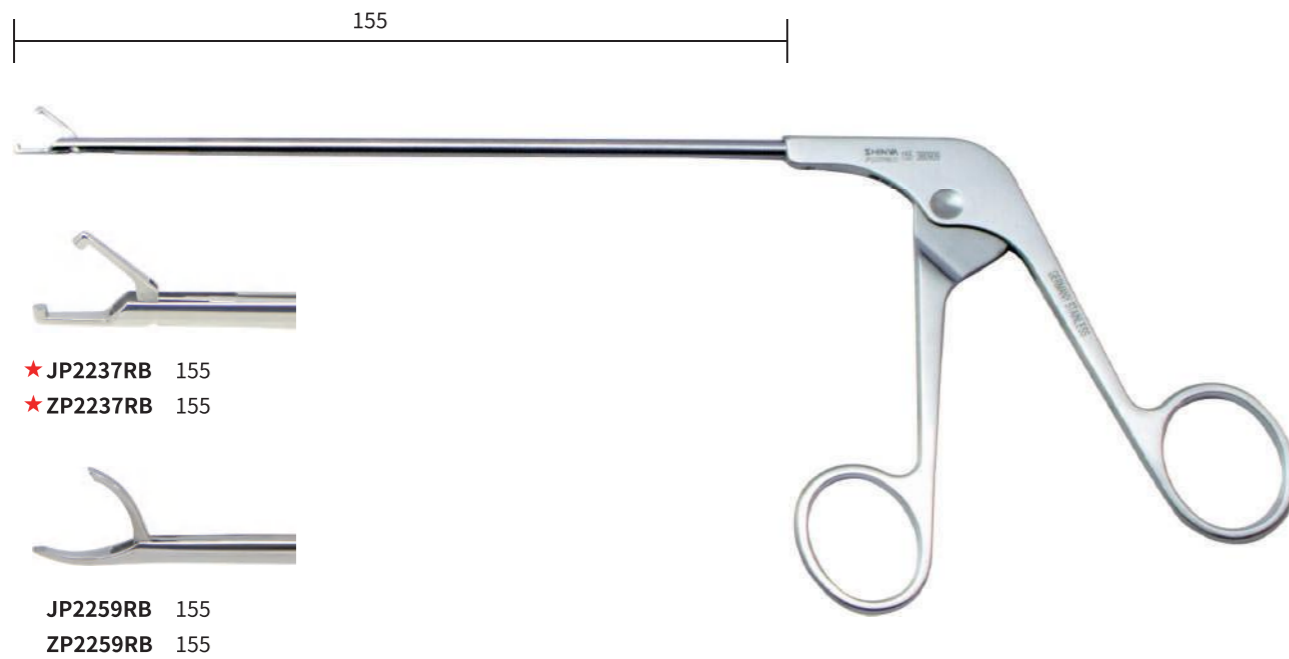

关节钳  
Grasper

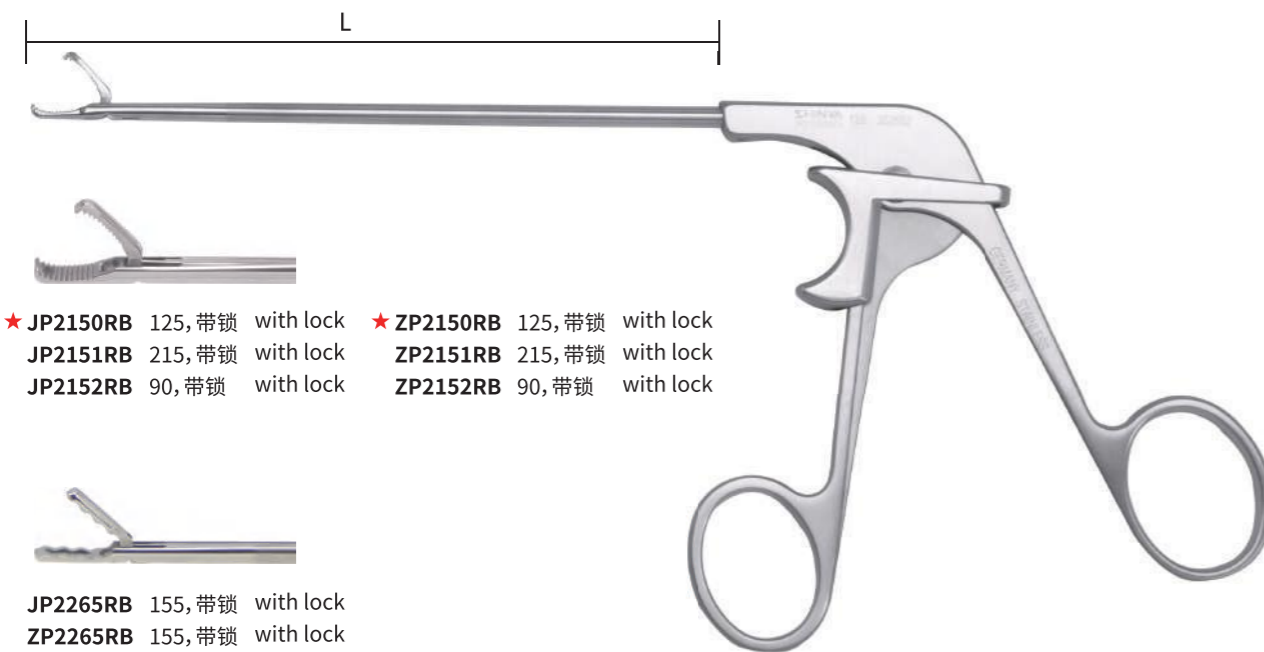

剪线器  
Suture Cutter

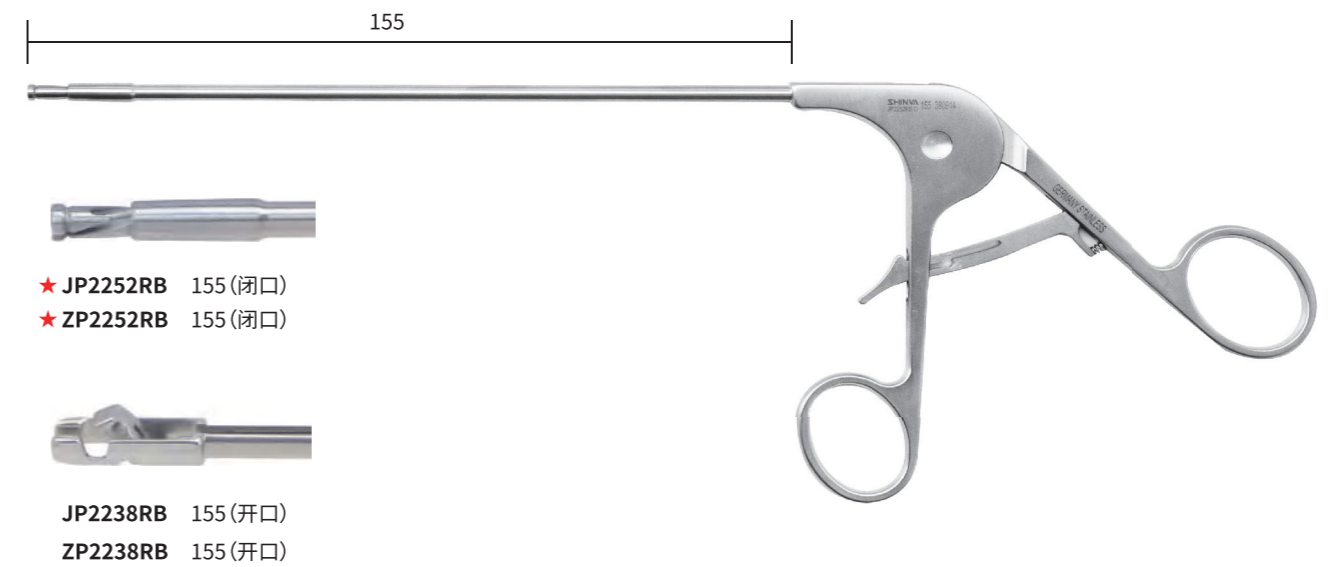

关节剪  
Scissors

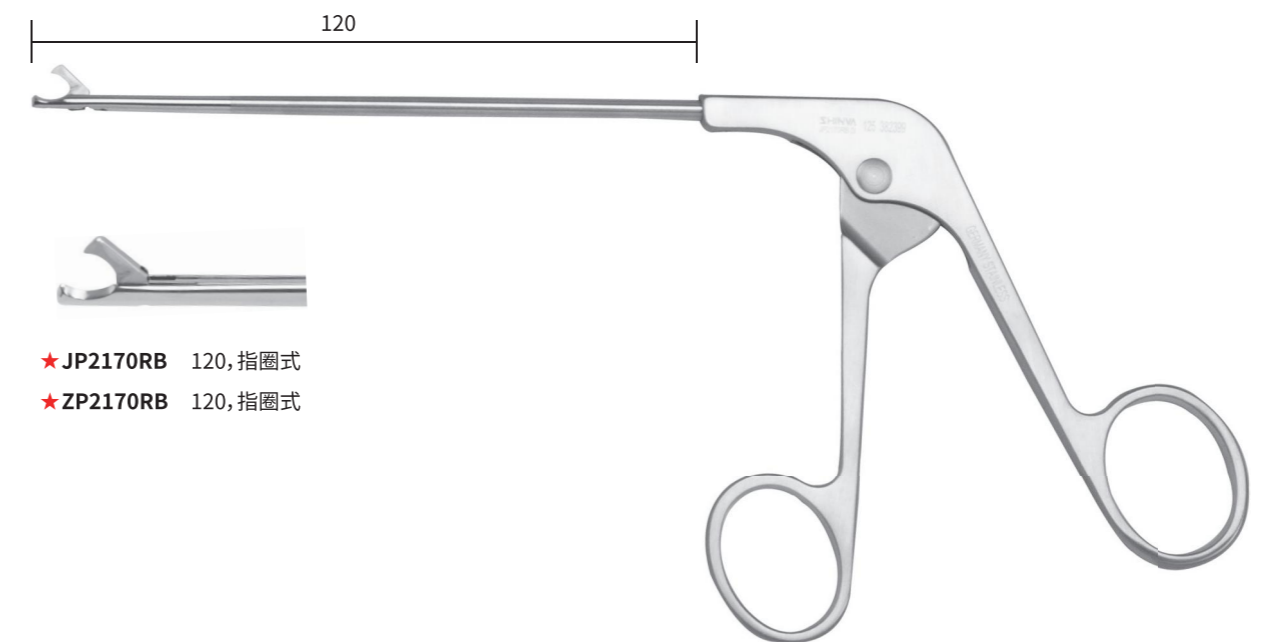

关节剪  
Scissors

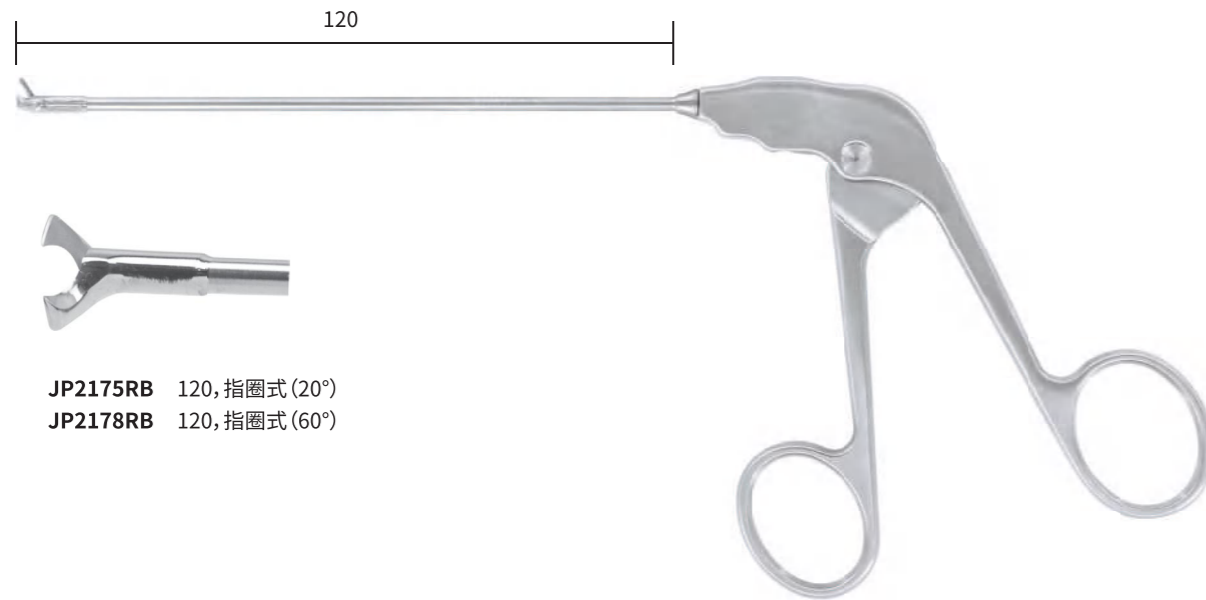

JP2175RB 120, 指圈式 (20°)  
JP2178RB 120, 指圈式 (60°)

关节剪  
Scissors

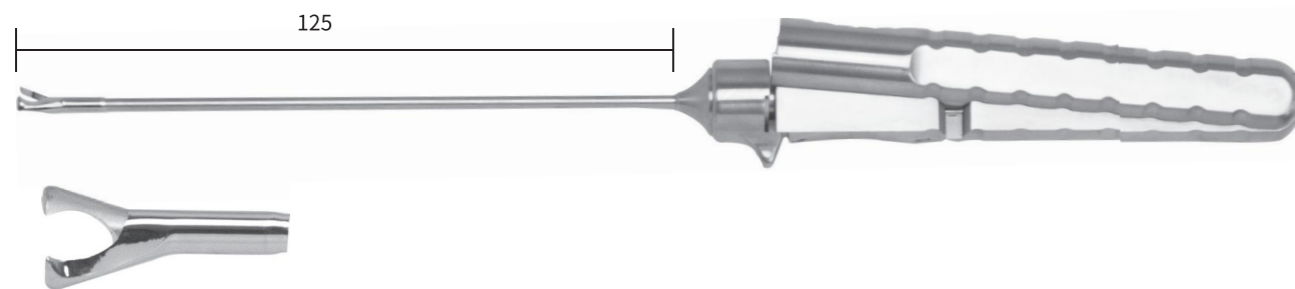

JP2173RB 125, 雪茄式 (20°)  
JP2177RB 125, 雪茄式 (60°)

推结器  
Knot Pusher

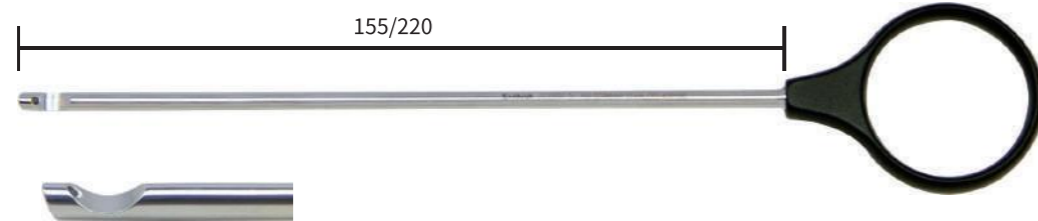

★ JP2256RB 155    ★ ZP2256RB 155  
JP2257RB 220    ZP2257RB 220

缝合钳  
Suture Passers

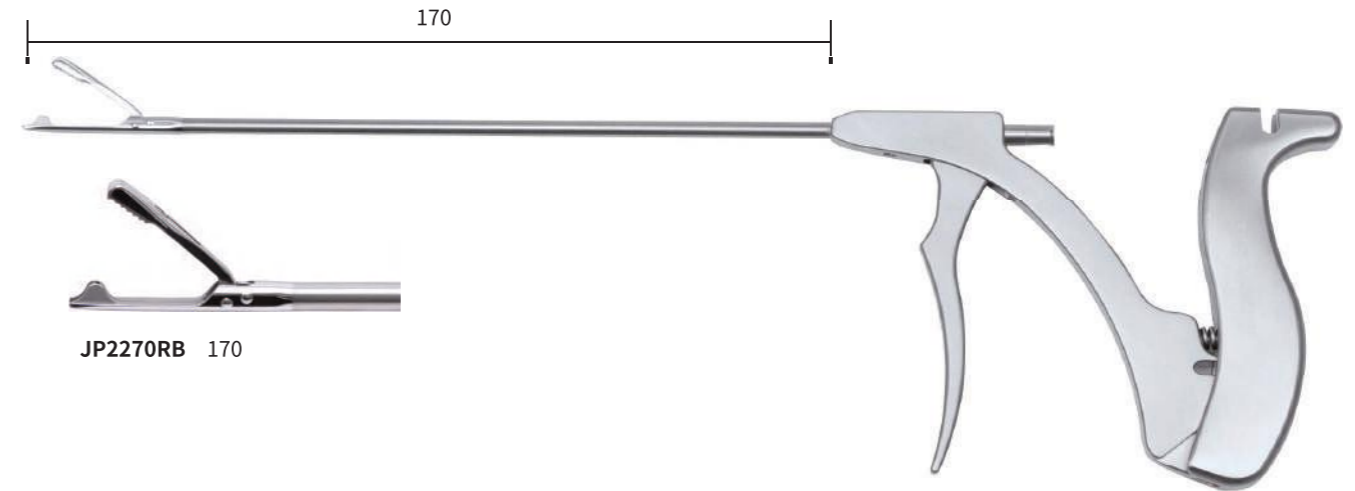

JP2270RB 170

骨牵引针  
Guiding Wire



JP2274RB 170, 带槽

交换棒  
Exchange rod

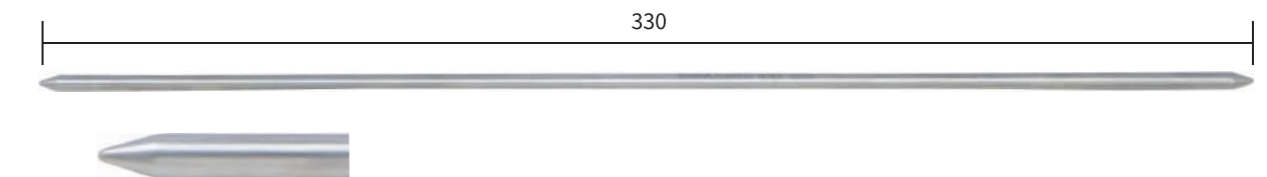

★ ZP2280RN  $\phi 4.3 \times 330$ , 圆型  
ZP2281RN  $\phi 4 \times 330$ , 圆型 (中空) cannulated  
ZP2282RN  $\phi 4.2 \times 330$ , 圆型

显微刀  
Micro reamer



ZP2290RN 240 $\times$ 4.4, 弯型 (可拆) detachable

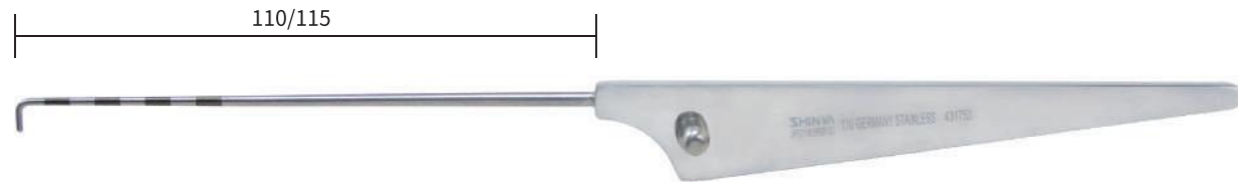

探针  
Probe

- ★ JP2180RB 115 (3)    ★ ZP2180RB 115 (3)
- JP2183RB 115 (5)    ZP2183RB 115 (5)

手术刀  
Knife



- JP2191RB 110, 反角形    ZP2191RB 110, 反角形

手术刀  
Knife



- JP2194RB 110, 香蕉形    ZP2194RB 110, 香蕉形

手术刀  
Knife



- ★ JP2197RB 110, 镰刀形    ★ ZP2197RB 110, 镰刀形

手术刀  
Knife



- JP2207RB 110, 半月板    ZP2207RB 110, 半月板

平锉  
File



- JP2219RB 115, (细齿)    ZP2219RB 115, (细齿)

刮匙  
Curette



- ★ JP2213RB 115 (3)    ★ ZP2213RB 115 (3)
- JP2214RB 115 (5)    ZP2214RB 115 (5)

手术刀  
Knife



- JP2193RB 110, 香蕉形    ZP2193RB 110, 香蕉形

手术刀  
Knife



- JP2196RB 110, 玫瑰形    ZP2196RB 110, 玫瑰形

手术刀  
Knife



- ★ JP2198RB 110, 钩形    ★ ZP2198RB 110, 钩形

手术刀  
Knife



- JP2209RB 110, 韧带松弛    ZP2209RB 110, 韧带松弛

平锉  
File



- JP2220RB 115, (粗齿)    ZP2220RB 115, (粗齿)

骨科用穿线器  
Suture Passer

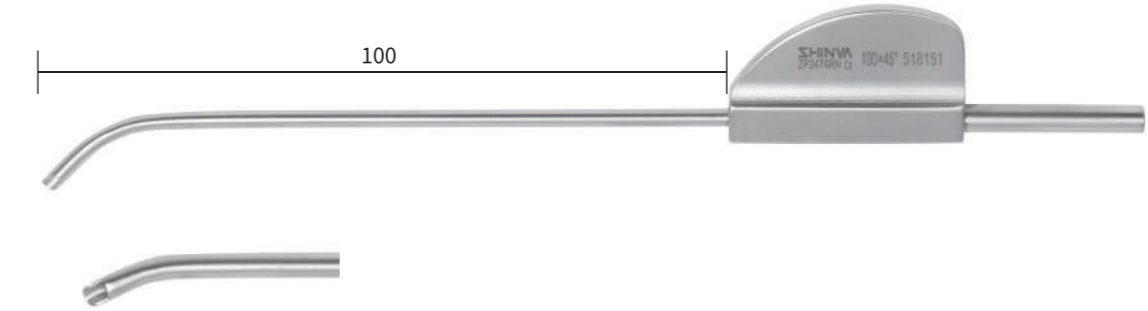

- ★ ZP2473RN 100×30°, 左弯 left curved
- ★ ZP2476RN 100×30°, 右弯 right curved



- ZP2474RN 100×45°, 左弯 left curved
- ZP2477RN 100×45°, 右弯 right curved



- ZP2475RN 100×65°, 左弯 left curved
- ZP2478RN 100×65°, 右弯 right curved

穿孔针  
Pin Punch



- ★ ZP2471RN 80, 尖头(直) straight
- ZP2472RN 80, 尖头(弯) curved

小切口手术缝合线拉钩  
Suture Catcher

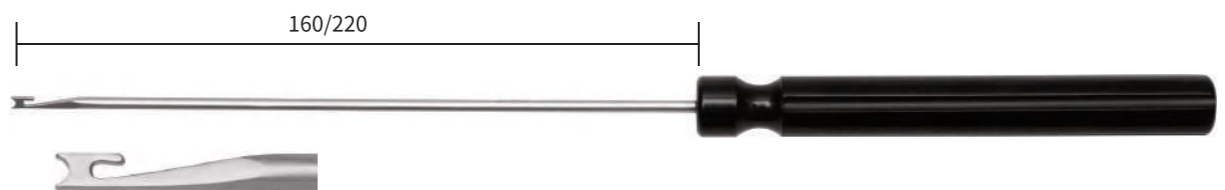

- ★ ZP2494RN 160, U型 U shaped
- ZP2493RN 220, 圆头 round tip

结扎缝合引线器  
Suture Guide



★ ZP2401RN 直型



ZP2404RN 左弯 (45°) left curved  
ZP2405RN 右弯 (45°) right curved



ZP2406RN 左弯 (60°) left curved  
ZP2407RN 右弯 (60°) right curved

骨科用穿线器  
Suture Passer

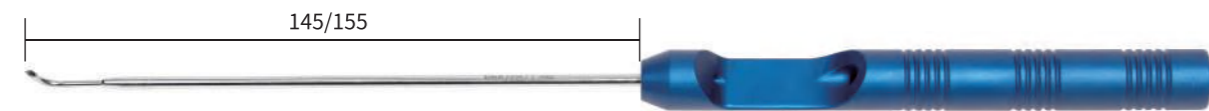

★ ZP2410RN 155, 直 straight



★ ZP2415RN 155×45°, 左弯 left curved  
★ ZP2416RN 155×45°, 右弯 right curved



ZP2419RN 145×90°, 左弯 left curved  
ZP2420RN 145×90°, 右弯 right curved

交叉韧带定位系统  
Cruciate Ligament Positioning System



导向手柄  
Handle



★ ZP2501RN 110

导向管  
Guiding Sleeve



ZP2502RN  $\Phi 3$

导向管  
Guiding Sleeve



★ ZP2503RN  $\Phi 2.5$

瞄准臂  
ACL tip aimer



★ ZP2510RN 点对点

瞄准臂  
ACL elbow aimer



ZP2511RN 点对肘

瞄准臂  
PCL tibial aimer



ZP2512RN 后叉胫骨

瞄准臂  
PCL femoral aimer



ZP2513RN 后叉股骨

交叉韧带定位系统  
All-inside Craciate Ligament Positioning System



导向手柄  
Handle



ZP2700RN 110

导向管  
Guiding Sleeve



ZP2711RN  $\Phi$ 2.5

导向管  
Guiding Sleeve



ZP2713RN  $\Phi$ 3.5

瞄准臂  
PCL tibial aimer



ZP2721RN PCL 胫骨 tibia

瞄准臂  
PCL femoral aimer



ZP2722RN PCL 股骨 femur

瞄准臂  
ACL femoral aimer



ZP2723RN ACL 股骨 femur

瞄准臂  
ACL tibial aimer



ZP2724RN ACL 胫骨 tibia

直径尺  
Diameter Ruler

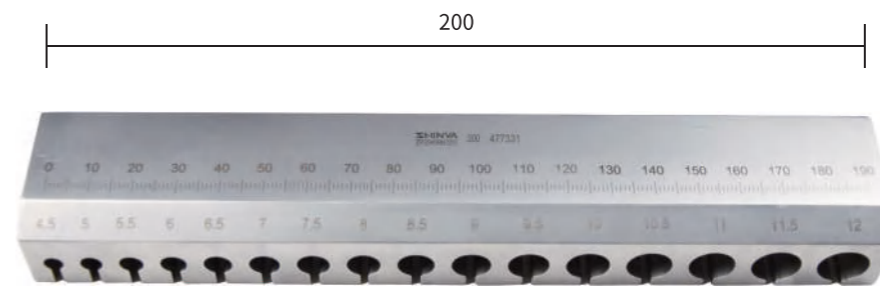

ZP2540RN 200, 测量器

后又保护器  
Back Ligament Protector



ZP2563RN 120

测探器  
Depth Gauge



ZP2561RN 240

取腱器  
Tendon stripper

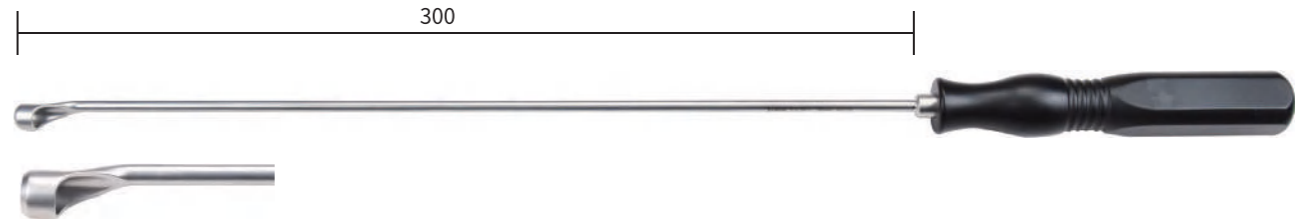

ZP2572RN  $\Phi$ 7

空心钻  
Cannulated Twist Drill for tibia

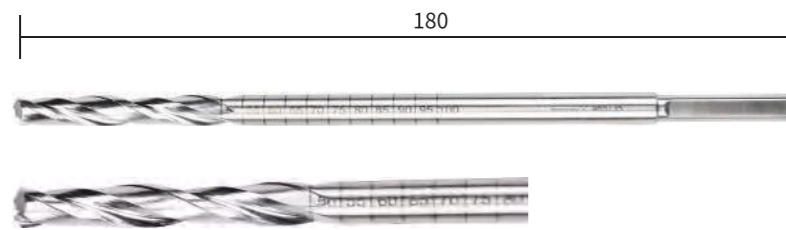

- ZP2590RN  $\Phi 5$ , 胫骨
- ZP2591RN  $\Phi 6$ , 胫骨
- ZP2592RN  $\Phi 7$ , 胫骨
- ZP2593RN  $\Phi 8$ , 胫骨
- ZP2594RN  $\Phi 9$ , 胫骨
- ZP2595RN  $\Phi 10$ , 胫骨

空心钻  
Cannulated Twist Drill for femur

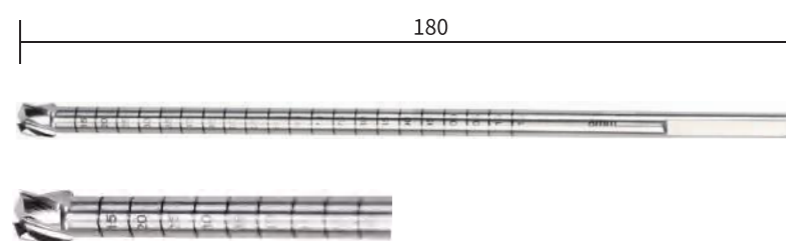

- ZP2610RN  $\Phi 5$ , 股骨
- ZP2611RN  $\Phi 6$ , 股骨
- ZP2612RN  $\Phi 7$ , 股骨
- ZP2613RN  $\Phi 8$ , 股骨
- ZP2614RN  $\Phi 9$ , 股骨
- ZP2615RN  $\Phi 10$ , 股骨
- ★ ZP2618RN  $\Phi 4.5$ , 股骨

骨钻  
Bone Drill

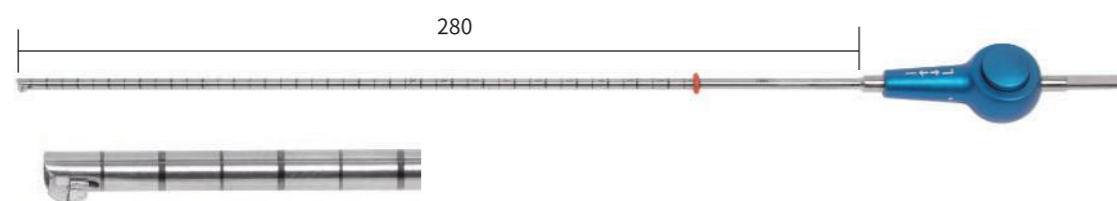

- ZP2703RB  $\Phi 7$
- ★ ZP2704RB  $\Phi 8$
- ZP2705RB  $\Phi 9$

股骨瞄准器  
Femur Aimer



- ZP2522RN 5
- ★ ZP2523RN 6
- ZP2524RN 7

定位针  
Positioning Pin

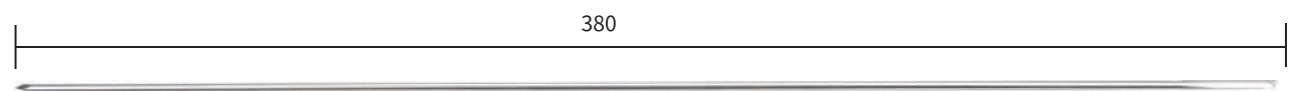

- ★ ZP2535RN  $\Phi 2.4$
- ZP2530RN  $\Phi 1$

骨锉  
Bone File

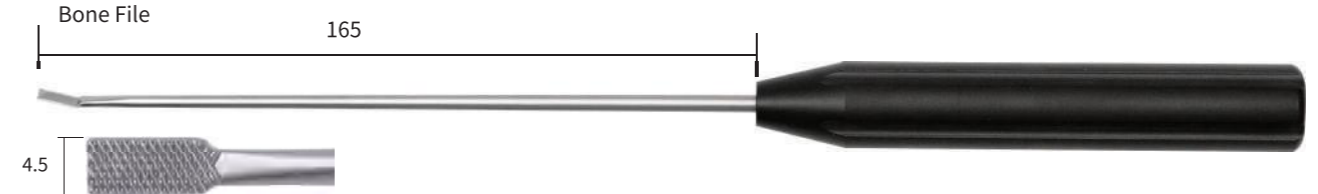

- ★ ZP2490RN 165, 弯(上) upward curved
- ZP2491RN 165, 弯(下) backward curved

骨刀  
Osteotome

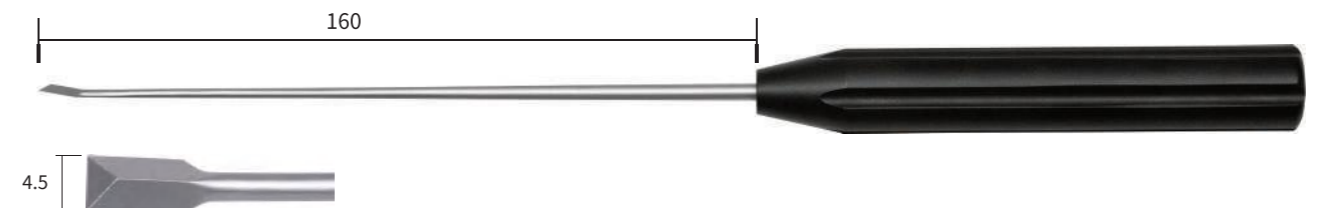

- ZP2630RN  $160 \times 4.5 \times 15^\circ$ , 前弯 forward curved
- ★ ZP2631RN  $160 \times 4.5 \times 15^\circ$ , 后弯 backward curved
- ZP2632RN  $160 \times 4.5 \times 30^\circ$ , 前弯 forward curved
- ZP2633RN  $160 \times 4.5 \times 30^\circ$ , 后弯 backward curved

骨刀  
Osteotome



ZP2646RN 110×4, 弯 curved



ZP2647RN 110×6, 弯 curved

骨凿  
Chisel



ZP2651RN 240×4, 直 straight

ZP2652RN 240×4, 弯 curved

ZP2653RN 240×6, 直 straight

ZP2654RN 240×6, 弯 curved

骨刮匙  
Bone Curette Cannulated

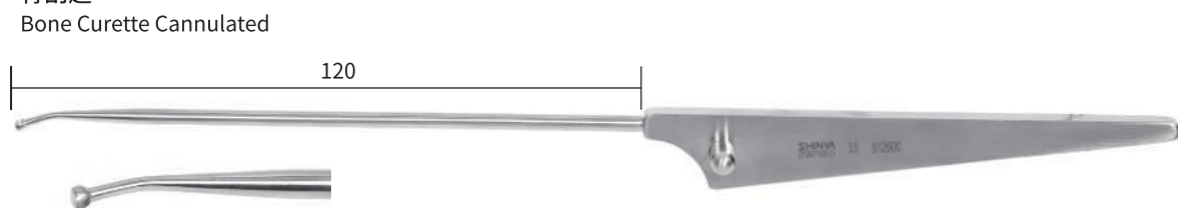

ZP2671RB 120×3.5, 空心

ZP2672RB 120×4.5, 空心

ZP2673RB 120×5.5, 空心

骨刮匙  
Bone Curette Cannulated



★ ZP2641RN 110×3.5×15°, 空心

ZP2642RN 110×5×15°, 空心

打孔器  
Punch



ZP2742RN 120×Φ3.5

ZP2744RN 120×Φ5

骨用丝锥  
Screw Tap



ZP2746RN Φ4.6×140

ZP2747RN Φ4.8×140

ZP2748RN Φ5.2×140

开口锥  
Opening awl



ZP2751RN 140×2.7

ZP2752RN 140×3.8

ZP2753RN 140×5.8

ZP2754RN 230×5

微骨折锥  
Microfracture Awl



- |  |                   |                     |                 |                     |
|--|-------------------|---------------------|-----------------|---------------------|
|  | <b>JP2225RB</b>   | 125, 直 straight     | <b>JP2230RB</b> | 215, 直 straight     |
|  | ★ <b>JP2226RB</b> | 125, 弯 (25°) curved | <b>JP2231RB</b> | 215, 弯 (25°) curved |
|  | ★ <b>JP2227RB</b> | 125, 弯 (40°) curved | <b>JP2232RB</b> | 215, 弯 (40°) curved |
|  | <b>JP2228RB</b>   | 125, 弯 (60°) curved | <b>JP2233RB</b> | 215, 弯 (60°) curved |
|  | <b>JP2229RB</b>   | 125, 弯 (90°) curved | <b>JP2234RB</b> | 215, 弯 (90°) curved |

微骨折锥  
Microfracture Awl



- |  |                   |                     |
|--|-------------------|---------------------|
|  | ★ <b>ZP2661RN</b> | 120, 弯 (25°) curved |
|  | ★ <b>ZP2662RN</b> | 120, 弯 (40°) curved |
|  | <b>ZP2663RN</b>   | 120, 弯 (60°) curved |
|  | <b>ZP2664RN</b>   | 120, 弯 (90°) curved |

打入器  
Impactor

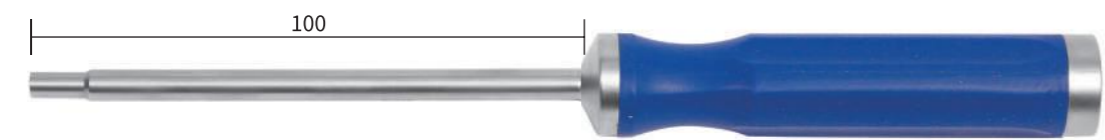

- |  |                 |     |
|--|-----------------|-----|
|  | <b>ZP2670RN</b> | 100 |
|--|-----------------|-----|

足踝微骨折器械  
Ankle Microfracture Instruments

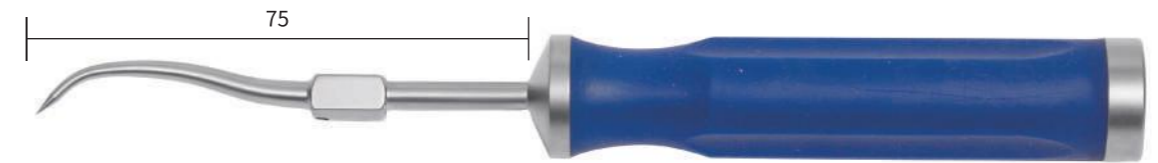

骨锥  
Bone Awl



- |                 |                     |
|-----------------|---------------------|
| <b>ZP2760RN</b> | 170, 弯 (25°) curved |
|-----------------|---------------------|

骨锥  
Bone Awl



- |                   |                     |
|-------------------|---------------------|
| ★ <b>ZP2761RN</b> | 170, 弯 (40°) curved |
|-------------------|---------------------|

骨锥  
Bone Awl



- |                   |                     |
|-------------------|---------------------|
| ★ <b>ZP2762RN</b> | 170, 弯 (60°) curved |
|-------------------|---------------------|

骨锥  
Bone Awl



- |                 |                     |
|-----------------|---------------------|
| <b>ZP2763RN</b> | 170, 弯 (90°) curved |
|-----------------|---------------------|

打入器  
Impactor



- |                 |     |
|-----------------|-----|
| <b>ZP2764RN</b> | 170 |
|-----------------|-----|

骨刮匙  
Bone Curette



- |                 |                             |
|-----------------|-----------------------------|
| <b>ZP2765RN</b> | 170×5×15°, 双刃 double blades |
| <b>ZP2766RN</b> | 170×3×15°, 双刃 double blades |
| <b>ZP2767RN</b> | 170×2×15°, 双刃 double blades |

骨刮匙  
Bone Curette



- |                 |                        |
|-----------------|------------------------|
| <b>ZP2768RN</b> | 170×5, 单刃 single blade |
| <b>ZP2769RN</b> | 170×3, 单刃 single blade |
| <b>ZP2770RN</b> | 170×2, 单刃 single blade |

骨刀  
Chisel



- |                 |                              |
|-----------------|------------------------------|
| <b>ZP2771RN</b> | 170×15° (直) straight         |
| <b>ZP2772RN</b> | 170×15° (上弯) upward curved   |
| <b>ZP2773RN</b> | 170×15° (下弯) downward curved |
| <b>ZP2774RN</b> | 170×15° (窄形) narrow          |

探针  
Probe



- |                 |       |
|-----------------|-------|
| <b>ZP2775RN</b> | 170×5 |
|-----------------|-------|

快装手柄  
Handle, T-shape

ZQ4320RN 165, T型



骨凿  
Gouge



ZQ4310RN 105×6 (直径)  
ZQ4311RN 105×7 (直径)  
ZQ4312RN 105×8 (直径)  
ZQ4313RN 105×9 (直径)  
ZQ4314RN 105×10 (直径)

植骨器  
Bone grafting impactor



ZQ4315RN 135×φ5  
ZQ4316RN 135×φ6  
ZQ4317RN 135×φ7  
ZQ4318RN 135×φ8  
ZQ4319RN 135×φ9

导钻  
Drill guide

ZQ4305RN 55×φ6  
ZQ4306RN 55×φ7  
ZQ4307RN 55×φ8  
ZQ4308RN 55×φ9  
ZQ4309RN 55×φ10



打入器  
Impactor

ZQ4303RN 105



打入器  
Impactor

ZQ4304RN 150



扳手  
Wrench

ZQ4301RN 140, 双头



测深器  
Depth Gauge

ZQ4302RN 150



ZQ4300软骨移植器械  
cartilage grafting device

序号	产品编码	产品名称	规格型号	数量	单位
1	ZQ4301RN	扳手	140, 双头	1	把
2	ZQ4302RN	测深器	150	1	把
3	ZQ4303RN	打入器	105	2	把
4	ZQ4304RN	打入器	150	1	把
5	ZQ4305RN	导钻	55×φ6	1	把
6	ZQ4306RN	导钻	55×φ7	1	把
7	ZQ4307RN	导钻	55×φ8	1	把
8	ZQ4308RN	导钻	55×φ9	1	把
9	ZQ4309RN	导钻	55×φ10	1	把
10	ZQ4310RN	骨凿	105×6	1	把
11	ZQ4311RN	骨凿	105×7	1	把
12	ZQ4312RN	骨凿	105×8	1	把
13	ZQ4313RN	骨凿	105×9	1	把
14	ZQ4314RN	骨凿	105×10	1	把
15	ZQ4315RN	植骨器	135×φ5	1	把
16	ZQ4316RN	植骨器	135×φ6	1	把
17	ZQ4317RN	植骨器	135×φ7	1	把
18	ZQ4318RN	植骨器	135×φ8	1	把
19	ZQ4319RN	植骨器	135×φ9	1	把
20	ZQ4320RN	快装手柄	165, T型	2	把



ZP2000 膝关节手术器械  
Knee joint instruments set

序号	产品编码	产品名称	规格型号	数量	单位
1	JP2003RB	篮钳	125×3.2, 鸭嘴, 直	1	把
2	JP2021RB	篮钳	125×3.2, 鸭嘴, 左弯	1	把
3	JP2022RB	篮钳	125×3.2, 鸭嘴, 右弯	1	把
4	JP2023RB	篮钳	125×3.2, 鸭嘴, 上弯	1	把
5	JP2007RB	篮钳	125×3.2, 鸭嘴, 上翘	1	把
6	JP2038RB	篮钳	125×4.4, 卵圆形	1	把
7	JP2075RB	篮钳	115×2.2, 反咬切	1	把
8	JP2074RB	篮钳	115×2.2, 反咬切	1	把
9	JP2076RB	篮钳	125×2.2, 侧咬切	1	把
10	JP2077RB	篮钳	125×2.2, 侧咬切	1	把
11	JP2150RB	关节钳	125, 带锁	1	把
12	JP2180RB	探针	115	1	把
13	JP2173RB	关节剪	125, 雪茄式	1	把
14	JP2198RB	手术刀	110, 钩形	1	把



ZP2100 肩关节手术器械  
Shoulder joint instruments set

序号	产品编码	产品名称	规格型号	数量	单位
1	JP2242RB	穿线钳	155, 直	1	把
2	JP2244RB	穿线钳	155, 弯	1	把
3	JP2245RB	穿线钳	155, 弯	1	把
4	JP2247RB	穿线钳	155, 弯	1	把
5	JP2237RB	抓线器	155	1	把
6	JP2252RB	剪线器	155	1	把
7	JP2256RB	推结器	155	1	把
8	JP2265RB	关节钳	155, 带锁	1	把
9	ZP2490RN	骨锉	165, 弯	1	把
10	ZP2631RN	骨刀	160×4.5×15°, 后弯	1	把
11	ZP2494RN	小切口手术缝合线拉钩	160, U型	1	把
12	JP2183RB	探针	115	1	把
13	ZP2280RN	骨牵引针	Φ4.3×330, 圆型	1	把
14	ZP2401RN	结扎缝合引线器	直型	1	把
15	ZP2404RN	结扎缝合引线器	左弯	1	把
16	ZP2405RN	结扎缝合引线器	右弯	1	把
17	ZP2406RN	结扎缝合引线器	左弯	1	把
18	ZP2407RN	结扎缝合引线器	右弯	1	把



ZP2200 交叉韧带重建器械  
Cruciate ligament Reconstruction instruments set

序号	产品编码	产品名称	规格型号	数量	单位
1	ZP2501RN	导向手柄 DXSB-110	110	1	把
2	ZP2502RN	导向管 DXG-3	Φ3	1	把
3	ZP2503RN	导向管 DXG-2.5	Φ2.5	1	把
4	ZP2510RN	瞄准臂 MZB-D	点对点	1	把
5	ZP2511RN	瞄准臂 MZB-Z	点对肘	1	把
6	ZP2512RN	瞄准臂 MZB-JG	后叉胫骨	1	把
7	ZP2513RN	瞄准臂 MZB-GG	后叉股骨	1	把
8	ZP2522RN	股骨瞄准器 GMQ-5	5	1	把
9	ZP2523RN	股骨瞄准器 GMQ-6	6	1	把
10	ZP2540RN	直径尺	200, 测量器	1	个
11	ZP2561RN	测深器 CSQ-240	240	1	把
12	ZP2563RN	后叉保护器 BHQ-120	120	1	把
13	ZP2572RN	取腱器 QJQ-7	Φ7	1	把
14	ZP2493RN	小切口手术缝合线拉钩	220, 圆头	1	把
15	ZP2618RN	空心钻 GGZ-4.5	Φ4.5, 股骨	1	个
16	ZP2611RN	空心钻 GGZ-6	Φ6, 股骨	1	个
17	ZP2612RN	空心钻 GGZ-7	Φ7, 股骨	1	个
18	ZP2613RN	空心钻 GGZ-8	Φ8, 股骨	1	个
19	ZP2614RN	空心钻 GGZ-9	Φ9, 股骨	1	个
20	ZP2615RN	空心钻 GGZ-10	Φ10, 股骨	1	个
21	ZP2591RN	空心钻 JGZ-6	Φ6, 胫骨	1	个
22	ZP2592RN	空心钻 JGZ-7	Φ7, 胫骨	1	个
23	ZP2593RN	空心钻 JGZ-8	Φ8, 胫骨	1	个
24	ZP2594RN	空心钻 JGZ-9	Φ9, 胫骨	1	个
25	ZP2595RN	空心钻 JGZ-10	Φ10, 胫骨	1	个
26	ZP2535RN	定位针 DWZ-2.4	Φ2.4	1	个
27	ZP2530RN	骨牵引针	Φ1	1	个

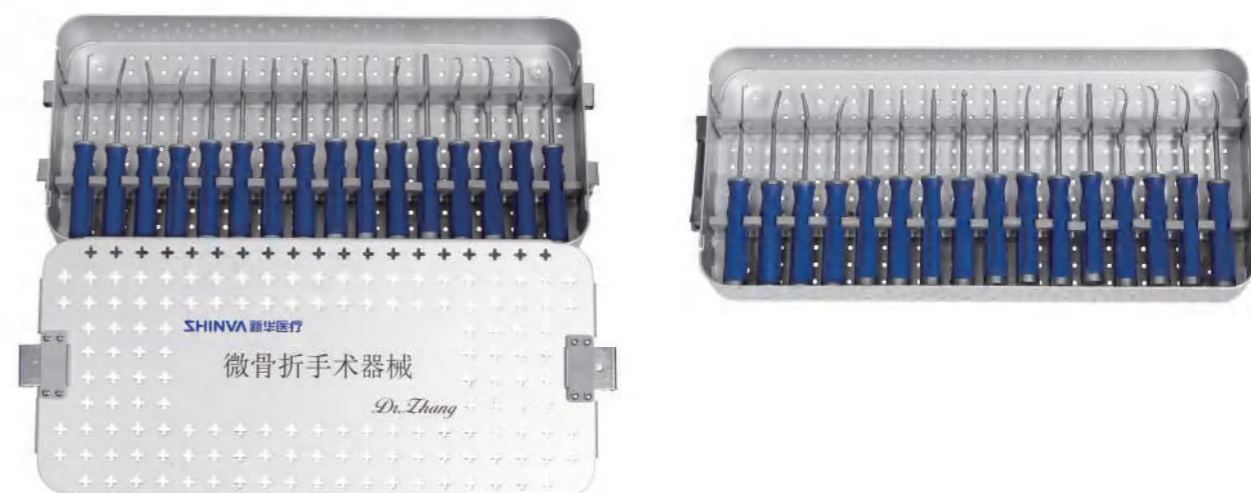

ZP2400 微骨折手术器械  
Microfracture instruments set

序号	产品编码	产品名称	规格型号	数量	单位
1	ZP2760RN	骨锥	170, 弯	1	把
2	ZP2761RN	骨锥	170, 弯	1	把
3	ZP2762RN	骨锥	170, 弯	1	把
4	ZP2763RN	骨锥	170, 弯	1	把
5	ZP2764RN	打入器	170	1	把
6	ZP2765RN	骨刮匙	170×5×15°, 双刃	1	把
7	ZP2766RN	骨刮匙	170×3×15°, 双刃	1	把
8	ZP2767RN	骨刮匙	170×2×15°, 双刃	1	把
9	ZP2768RN	骨刮匙	170×5, 单刃	1	把
10	ZP2769RN	骨刮匙	170×3, 单刃	1	把
11	ZP2770RN	骨刮匙	170×2, 单刃	1	把
12	ZP2771RN	骨刀	170×15°	1	把
13	ZP2772RN	骨刀	170×15°	1	把
14	ZP2773RN	骨刀	170×15°	1	把
15	ZP2774RN	骨刀	170×15°	1	把
16	ZP2775RN	探针	170×5	1	把

### 手术钳 Forceps and Punches

**锋利**  
Sharp

钳头采用进口特种钢材加工,全面提升刃口性能,获得柔顺咬切体验。  
Working parts made of German steel to ensure cutting sharpness.

**安全**  
Safe

髓核钳、抓钳手柄过载卸力结构设计,延长芯轴使用寿命。  
Forceps handle with overload protection design to gain longer life time.

**洁净**  
Clean

杆部设有冲洗口,有效清除管腔内污物。  
Irrigation hole in the shank to clean inside thoroughly.

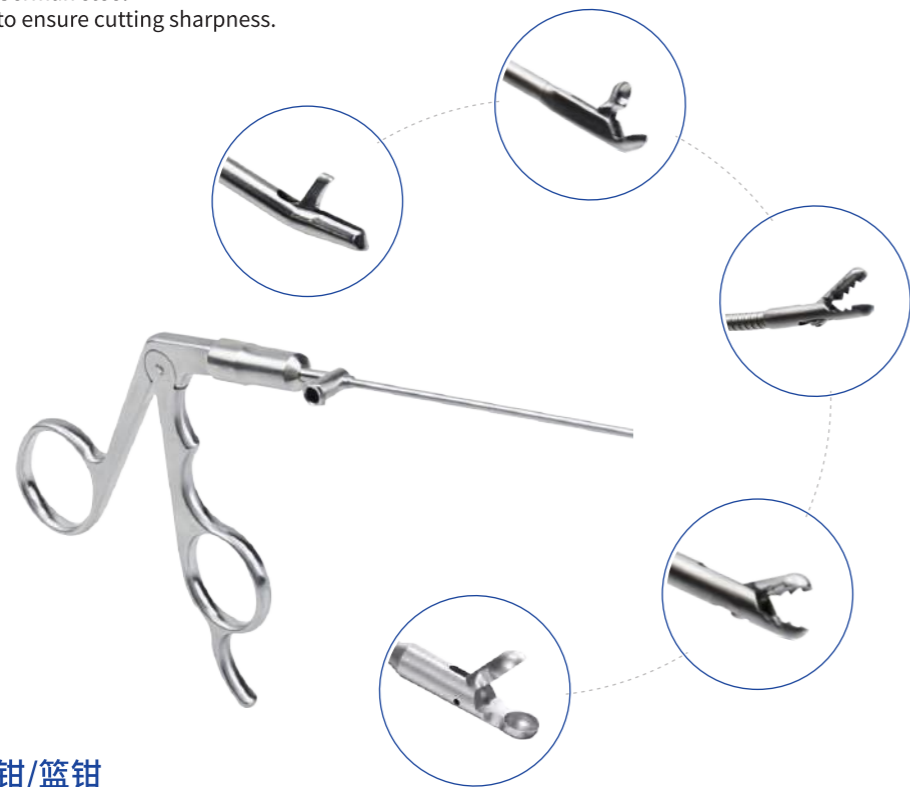

髓核钳/抓钳/篮钳  
Laminectomy forceps/grasping forceps/basket punch

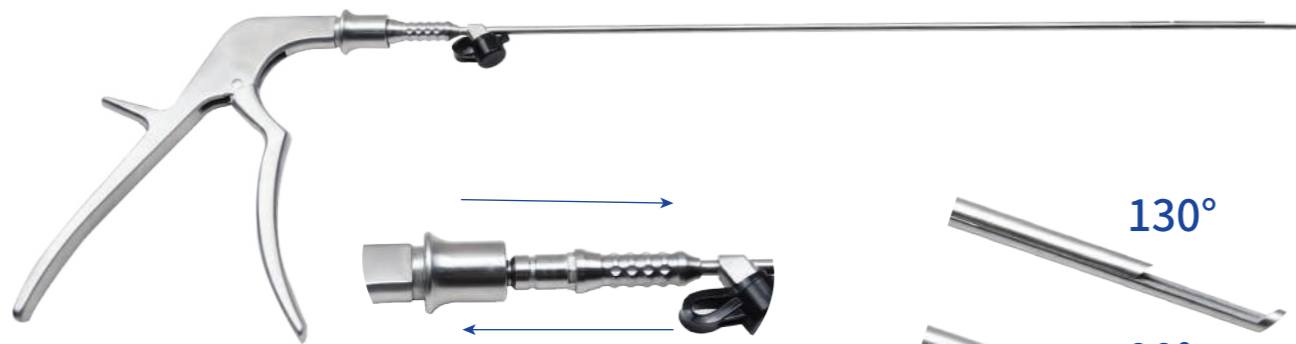

- 快捷可拆设计 quick detaching design
- 八向角度调节 8 directions adjustment

椎板咬骨钳  
Kerrison punch

### 可视环锯系统 Visible trephine system

#### 可视化环锯技术 Visible trephine technology

1. 内镜下直视关节突成型;
  2. 安全、可视抵达目标靶点;
  3. 手术操作高效、简单。
1. Full endoscopic foraminoplasty;
  2. Visible and safe cutting;
  3. Simple and quick operation.



环锯手柄人体工学设计,舒适省力。  
Ergonomic handle for comfortable holding



1. 环锯内壁安全刻线设计,精确判断深度;
  2. 特种钢材,锋利刃口,兼具优异的韧性与硬度。
1. Trephine inside graduated for depth estimate;
  2. Special steel for sharper cutting.

#### UA套管(专利产品) UA sleeve(patented)



精简手术操作,无需置换套管,避免移位,提高手术效率。  
No need to change working sleeve for faster operation and avoiding dislocation

### 切割环锯系统 Standard trephine system

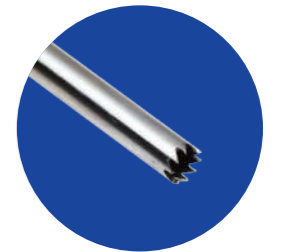
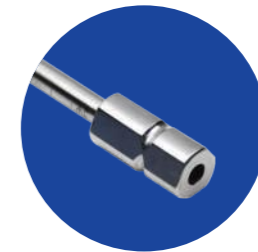

- T型锁定手柄,拆装快捷  
Quick coupling T handle
- 一体式环锯,牢固可靠  
One part processing for longer life time
- 进口钢材,锋利耐用  
German steel for sharper cutting
- 3.5/4/5/6.5/7.5多种规格供选择  
3.5/4/5/6.5/7.5mm available
- 精确刻度标记  
Graduated for easy operation

### 安全骨钻系统 Safe bone drill system

**安全 Safe**  
骨钻安全钝头设计, 避免神经根、硬膜囊损伤。  
Bone drill with blunt tip to avoid damaging nerves.

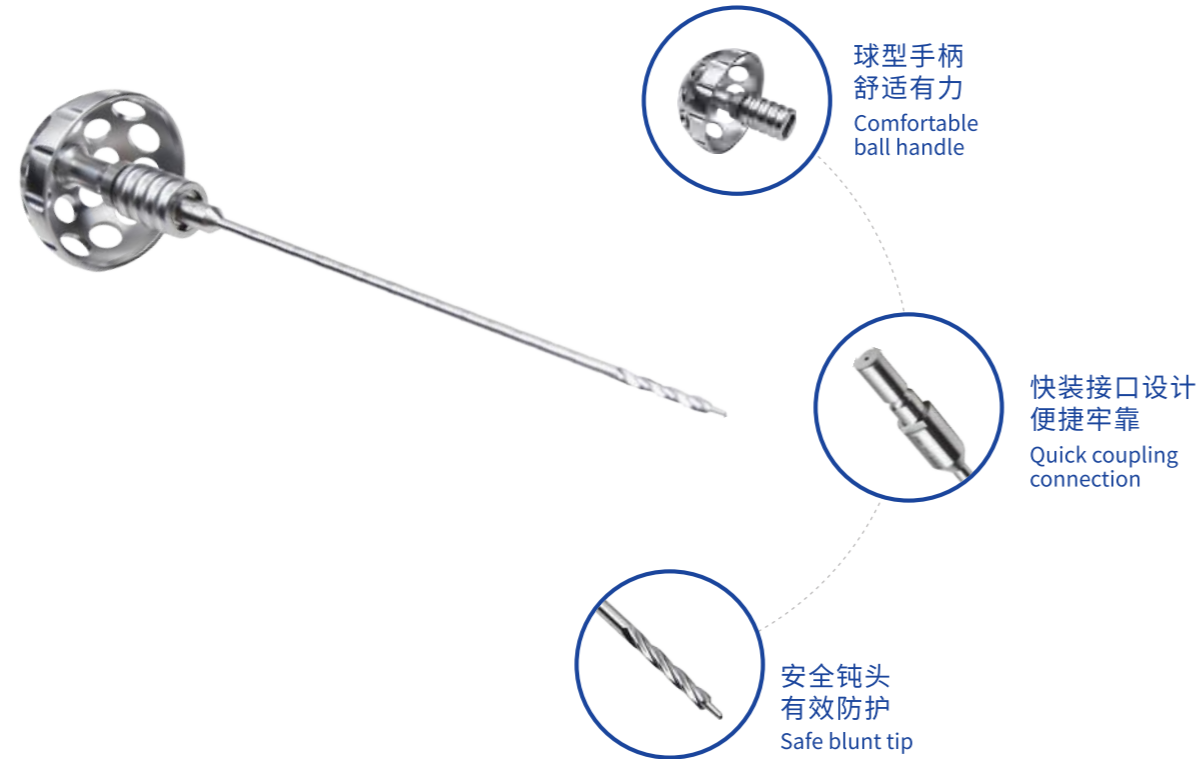

**精准 Precise**  
三种定位针应用, 确保通道建立准确。  
Three bone needles available for precise channel.



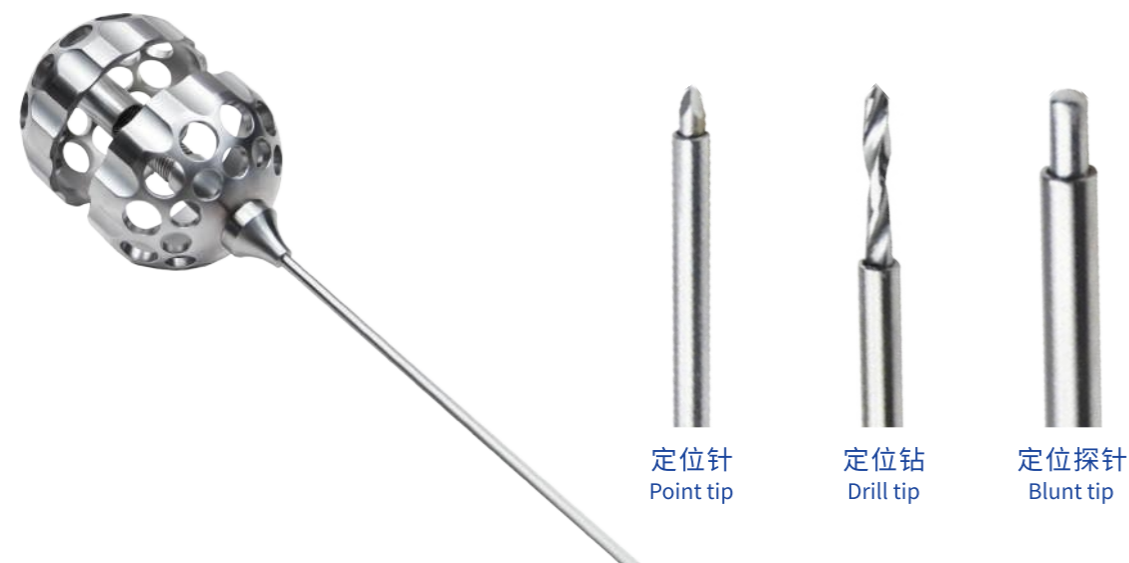



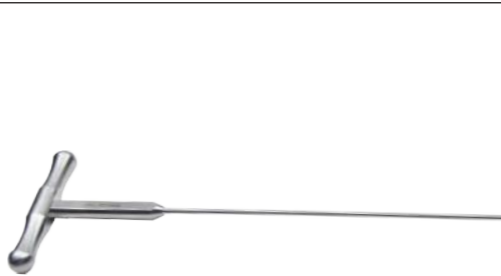
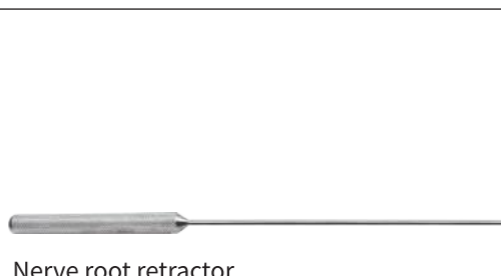
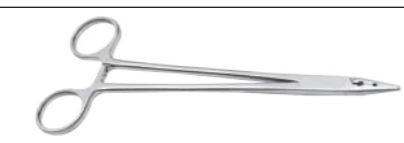

### TOM针 TOM SHIDI needles

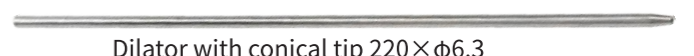

编码 Article No.	名称/规格 Description	图示 Photo
★ ZQ4002RB	髓核钳SHQ-L2.5 330×φ2.5, 匙形, 直 330×φ2.5, Straight	
★ ZQ4004RB	髓核钳SHQ-L3.5 330×φ3.5, 匙形, 直 330×φ3.5, Straight	
★ ZQ4008RB	髓核钳SHQ-WL2.5 330×φ2.5×45°, 匙形, 上翘 330×φ2.5×45°, Upward angled	
★ ZQ4010RB	抓钳ZQ-L2.5 330×φ2.5, 锯齿形, 直 330×φ2.5, Straight	
ZQ4011RB	抓钳ZQ-L3.5 330×φ3.5, 锯齿形, 直 330×φ3.5, Straight	
★ ZQ4016RB	抓钳ZQ-TLJ2.5 330×φ2.5, 锯齿形, 可弯 (弹簧钳)	
ZQ4018RB	抓钳ZQ-TLC2.5 330×φ2.5, 匙形, 可弯 (弹簧钳)	
ZQ4020RB	篮钳LQ-L2.5 330×φ2.5, 直 330×φ2.5, Straight	
ZQ4022RB	篮钳LQ-L3.5 330×φ3.5, 直 330×φ3.5, Straight	
★ ZQ4025RB	篮钳LQ-WL2.5 330×φ2.5×15°, 上翘 330×φ2.5×15°, Upward angled	
★ ZQ4027RB	咬骨钳YGQ-L3.5 330×φ3.5, 可换头, 可旋转	 130° 90°

编码 Article No.	名称/规格 Description	图示 Photo
★ ZQ4030RB	剥离器BLQ-3 330×φ3, 弧形 330×φ3, Curved	 Dissector
ZQ4031RB	剥离器BLQ-2.5 330×φ2.5, 直形 330×φ2.5, Straight	
★ ZQ4032RB	骨凿GZ-3.5 360×φ3.5, 斜刃 360×φ3.5, Chisel	 Ostetome
★ ZQ4033RB	骨凿GZ-Y3 330×φ3, 圆刃 330×φ3, Gouge	
★ ZQ4034RB	骨凿GZ-Y3.5 330×φ3.5, 圆刃 330×φ3.5, Gouge	
ZQ4035RB	骨凿GZ-J3 330×φ3, 锥形 330×φ3, Osteotome	
★ ZQ4036RB	神经根拉钩SJLG-1 330×φ1×3.3, 平头 330×φ1×3.3, Flat tip	
ZQ4038RB	神经根拉钩SJLG-2 310×φ2×3.5, 球头 310×φ2×3.5, Ball tip	 Nerve root retractor
★ ZQ4037RB	神经根探子SJTZ-2.2 330×φ2.2, 直型, 球头 330×φ2.2, Ball tip	
ZQ4088RB	夹持钳JCQ-200 200 Holding forceps, 200	
★ ZQ4089RB	骨锤GC-230 230 Bone hammer, 230	
ZQ4090RB	医用尺YYC-300 300 Medical ruler, 300	



通道建立工具 Channel forming instruments

编码 Article No.	名称/规格 Description	图示 Photo
★ ZQ4082RB	导针DZ-0.8 450×φ0.8	 Guide wire 450×φ0.8, 450×φ1.0 450×φ1.2, 450×φ1.5
★ ZQ4083RB	导针DZ-1.0 450×φ1.0	
★ ZQ4084RB	导针DZ-1.2 450×φ1.2	
★ ZQ4085RB	导针DZ-1.5 450×φ1.5	
★ ZQ4066RB	扩张管KZG-3.5 230×φ3.5, 锥形口	
★ ZQ4067RB	扩张管KZG-6.3 200×φ6.3, 锥形口	 Dilator with conical tip 230×φ3.5, 200×φ6.3, 170×φ7.4
★ ZQ4068RB	扩张管KZG-7.4 170×φ7.4, 锥形口	
★ ZQ4074RB	扩张管KZG-B6.3 220×φ6.3, 铅笔头	 Dilator with conical tip 220×φ6.3
★ ZQ4069RB	扩张管KZG-2.5 230×φ2.5, 铅笔头	 Dilator with conical tip 230×φ2.5, 205×φ4, 190×φ5, 175×φ6, 160×φ8,
★ ZQ4070RB	扩张管KZG-4 205×φ4, 锥形口	
★ ZQ4071RB	扩张管KZG-5 190×φ5, 锥形口	
★ ZQ4072RB	扩张管KZG-6 175×φ6, 锥形口	
★ ZQ4073RB	扩张管KZG-8 160×φ8, 锥形口	 Dilator, two holes, 220×φ6.4
ZQ4075RB	扩张管KZG-SK6.4 220×φ6.4, 双孔	
ZQ4093RB	扩孔器 200×φ6.3	 Grooved bar 200×φ6.3
★ ZQ4053RB	工作套管TG-P8.5 160×φ8.5, 长柄	 Working sleeve for visible trephine
★ ZQ4054RB	工作套管TG-PL9 160×φ9, 长柄	

编码 Article No.	名称/规格 Description	图示 Photo
★ ZQ4056RB	工作套管TG-8 170×φ8,短柄	 Working sleeve 170×φ8, 170×φ7.5 170×φ6, 170×φ8.5
★ ZQ4058RB	工作套管TG-7.5 170×φ7.5,短柄	
ZQ4057RB	工作套管TG-6 170×φ6,短柄	
★ ZQ4059RB	工作套管TG-8.5 170×φ8.5,短柄	
★ ZQ4060RB	工作套管TG-A7.4 165×φ7.4,短柄	 Working sleeve 165×φ7.4, 165×φ7.8 UA套管
★ ZQ4061RB	工作套管TG-AL7.8 165×φ7.8,短柄	
★ ZQ4063RB	工作套管TG-U8.5 150×φ8.5,组合柄	 Protector 150×φ8.5, 150×φ9
★ ZQ4064RB	工作套管TG-UL9 150×φ9,组合柄	

椎间孔成型工具 Foraminoplasty instruments

编码 Article No.	名称/规格 Description	图示 Photo
★ ZQ4040RB	环锯HJ-7.5 175×φ7.5,一体式	 可视环锯:适配φ6.3和φ6.9内窥镜 visible trephine:for 6.3 and 6.9 spine endoscopes Trephine,one part 175×φ7.5, 175×φ8
★ ZQ4041RB	环锯HJ-L8 175×φ8,一体式	
★ ZQ4039RB	环锯HJ-3.5 350×φ3.5,分体式	 Trephine tip 350×φ3.5
ZQ4043RB	环锯HJ-4 225×φ4,分体式	 Trephine tip 225×φ4, 225×φ5 225×φ6.5, 225×φ7.5
ZQ4044RB	环锯HJ-5 225×φ5,分体式	
ZQ4045RB	环锯HJ-6.5 225×φ6.5,分体式	
★ ZQ4046RB	环锯HJ-7.5 225×φ7.5,分体式	 Trephine handle
★ ZQ4087RB	手术器械手柄SB-T 58, T型	
ZQ4094RB	扩孔器 250×φ6	 Dilator 250×φ6

编码 Article No.	名称/规格 Description	图示 Photo	
ZQ4079RB	定位针DWZ-SJ 170×φ3,三角状 170×φ3, Point tip	 Tom Shidi needle	
ZQ4080RB	定位针DWZ-LW 170×φ3, 螺纹状 170×φ3, Drill tip		
ZQ4081RB	定位针DWZ-YD 170×φ3, 圆钝 170×φ3, Blunt tip		
ZQ4047RB	手动骨钻SZ-4 235×φ4	 Bone drill tip 235×φ4 235×φ5 235×φ6 235×φ7 235×φ8 235×φ9	
ZQ4048RB	手动骨钻SZ-5 235×φ5		
ZQ4049RB	手动骨钻SZ-6 235×φ6		
ZQ4050RB	手动骨钻SZ-7 235×φ7		
ZQ4051RB	手动骨钻SZ-8 235×φ8		
ZQ4052RB	手动骨钻SZ-9 235×φ9		
ZQ4086RB	手术器械手柄SB-Q 70, 半球型		 Ball handle



I 椎间孔镜手术器械 (ZQ4000)  
Uniportal intervertebral foramen endoscope surgical instruments set

序号	产品编码	产品名称	规格型号	数量	单位
1	ZQ4002RB	髓核钳SHQ-L2.5	330×φ2.5,匙形,直	1	把
2	ZQ4004RB	髓核钳SHQ-L3.5	330×φ3.5,匙形,直	1	把
3	ZQ4008RB	髓核钳SHQ-WL2.5	330×φ2.5×45°,匙形,上翘	1	把
4	ZQ4010RB	抓钳ZQ-L2.5	330×φ2.5,锯齿形,直	1	把
5	ZQ4011RB	抓钳ZQ-L3.5	330×φ3.5,锯齿形,直	1	把
6	ZQ4016RB	抓钳ZQ-TLJ2.5	330×φ2.5,锯齿形,可弯	1	把
7	ZQ4025RB	篮钳LQ-WL2.5	330×φ2.5×15°,上翘	1	把
8	ZQ4027RB	咬骨钳YGQ-L3.5	330×φ3.5,可换头,可旋转	1	把
9	ZQ4030RB	剥离器BLQ-3	330×φ3,弧形	1	把
10	ZQ4034RB	骨凿GZ-Y3.5	330×φ3.5,圆刃	1	把
11	ZQ4036RB	神经根拉钩SJLG-1	330×φ1×3.3,平头	1	把
12	ZQ4037RB	神经根探子SJTZ-2.2	330×φ2.2,直型,球头	1	把
13	ZQ4088RB	夹持钳JCQ-200	200	1	把
14	ZQ4089RB	骨锤GC-230	230	1	把
15	ZQ4090RB	医用尺YYC-300	300	1	把
16	ZQ4082RB	导针DZ-0.8	450×φ0.8	1	把
17	ZQ4083RB	导针DZ-1.0	450×φ1.0	1	把
18	ZQ4085RB	导针DZ-1.5	450×φ1.5	1	把
19	ZQ4066RB	扩张管KZG-3.5	230×φ3.5,锥形口	1	把
20	ZQ4067RB	扩张管KZG-6.3	200×φ6.3,锥形口	1	把
21	ZQ4068RB	扩张管KZG-7.4	170×φ7.4,锥形口	1	把
22	ZQ4069RB	扩张管KZG-2.5	230×φ2.5,铅笔头	1	把

序号	产品编码	产品名称	规格型号	数量	单位
23	ZQ4070RB	扩张管KZG-4	205×φ4,锥形口	1	把
24	ZQ4071RB	扩张管KZG-5	190×φ5,锥形口	1	把
25	ZQ4072RB	扩张管KZG-6	175×φ6,锥形口	1	把
26	ZQ4073RB	扩张管KZG-8	160×φ8,锥形口	1	把
27	ZQ4074RB	扩张管KZG-B6.3	220×φ6.3,铅笔头	1	把
28	ZQ4075RB	扩张管KZG-SK6.4	220×φ6.4,双孔	1	把
29	ZQ4093RB	扩孔器	200×φ6.3	1	把
30	ZQ4053RB	工作套管TG-P8.5	160×φ8.5,长柄	1	把
31	ZQ4054RB	工作套管TG-PL9	160×φ9,长柄	1	把
32	ZQ4056RB	工作套管TG-8	170×φ8,短柄	1	把
33	ZQ4058RB	工作套管TG-7.5	170×φ7.5,短柄	1	把
34	ZQ4059RB	工作套管TG-8.5	170×φ8.5,短柄	1	把
35	ZQ4060RB	工作套管TG-A7.4	165×φ7.4,短柄	1	把
36	ZQ4061RB	工作套管TG-AL7.8	165×φ7.8,短柄	1	把
37	ZQ4063RB	工作套管TG-U8.5	150×φ8.5,组合柄	1	把
38	ZQ4064RB	工作套管TG-UL9	150×φ9,组合柄	1	把
39	ZQ4040RB	环锯HJ-7.5	175×φ7.5,一体式	1	把
40	ZQ4041RB	环锯HJ-L8	175×φ8,一体式	1	把
41	ZQ4039RB	环锯HJ-3.5	350×φ3.5,分体式	1	把
42	ZQ4046RB	环锯HJ-7.5	225×φ7.5,分体式	1	把
43	ZQ4087RB	手术器械手柄SB-T	58,T型	1	把
44	ZQ4094RB	扩孔器	250×φ6	1	把
45	ZQ4079RB	定位针DWZ-SJ	170×φ3,三角状	1	把
46	ZQ4080RB	定位针DWZ-LW	170×φ3,螺纹状	1	把
47	ZQ4081RB	定位针DWZ-YD	170×φ3,圆钝	1	把
48	ZQ4047RB	手动骨钻SZ-4	235×φ4	1	把
49	ZQ4048RB	手动骨钻SZ-5	235×φ5	1	把
50	ZQ4049RB	手动骨钻SZ-6	235×φ6	1	把
51	ZQ4050RB	手动骨钻SZ-7	235×φ7	1	把
52	ZQ4051RB	手动骨钻SZ-8	235×φ8	1	把
53	ZQ4052RB	手动骨钻SZ-9	235×φ9	1	把
54	ZQ4086RB	手术器械手柄SB-Q	70,半球型	1	把



II 椎间孔镜手术器械 (ZQ4100)

Uniportal intervertebral foramen endoscope surgical instruments set

序号	产品编码	产品名称	规格型号	数量	单位
1	ZQ4002RB	髓核钳SHQ-L2.5	330×φ2.5,匙形,直	1	把
2	ZQ4004RB	髓核钳SHQ-L3.5	330×φ3.5,匙形,直	1	把
3	ZQ4008RB	髓核钳SHQ-WL2.5	330×φ2.5×45°,匙形,上翘	1	把
4	ZQ4010RB	抓钳ZQ-L2.5	330×φ2.5,锯齿形,直	1	把
5	ZQ4011RB	抓钳ZQ-L3.5	330×φ3.5,锯齿形,直	1	把
6	ZQ4016RB	抓钳ZQ-TLJ2.5	330×φ2.5,锯齿形,可弯	1	把
7	ZQ4025RB	篮钳LQ-WL2.5	330×φ2.5×15°,上翘	1	把
8	ZQ4027RB	咬骨钳YGQ-L3.5	330×φ3.5,可换头,可旋转	1	把
9	ZQ4030RB	剥离器BLQ-3	330×φ3,弧形	1	把
10	ZQ4034RB	骨凿GZ-Y3.5	330×φ3.5,圆刃	1	把
11	ZQ4036RB	神经根拉钩SJLG-1	330×φ1×3.3,平头	1	把
12	ZQ4037RB	神经根探子SJTZ-2.2	330×φ2.2,直型,球头	1	把
13	ZQ4088RB	夹持钳JCQ-200	200	1	把
14	ZQ4089RB	骨锤GC-230	230	1	把
15	ZQ4090RB	医用尺YYC-300	300	1	把
16	ZQ4085RB	导针DZ-1.5	450×φ1.5	1	把
17	ZQ4066RB	扩张管KZG-3.5	230×φ3.5,锥形口	1	把
18	ZQ4067RB	扩张管KZG-6.3	200×φ6.3,锥形口	1	把
19	ZQ4068RB	扩张管KZG-7.4	170×φ7.4,锥形口	1	把
20	ZQ4073RB	扩张管KZG-8	160×φ8,锥形口	1	把
21	ZQ4093RB	扩孔器	200×φ6.3	1	把
22	ZQ4053RB	工作套管TG-P8.5	160×φ8.5,长柄	1	把

序号	产品编码	产品名称	规格型号	数量	单位
23	ZQ4054RB	工作套管TG-PL9	160×φ9,长柄	1	把
24	ZQ4056RB	工作套管TG-8	170×φ8,短柄	1	把
25	ZQ4058RB	工作套管TG-7.5	170×φ7.5,短柄	1	把
26	ZQ4060RB	工作套管TG-A7.4	165×φ7.4,短柄	1	把
27	ZQ4061RB	工作套管TG-AL7.8	165×φ7.8,短柄	1	把
28	ZQ4063RB	工作套管TG-U8.5	150×φ8.5,组合柄	1	把
29	ZQ4064RB	工作套管TG-UL9	150×φ9,组合柄	1	把
30	ZQ4040RB	环锯HJ-7.5	175×φ7.5,一体式	1	把
31	ZQ4041RB	环锯HJ-L8	175×φ8,一体式	1	把
32	ZQ4039RB	环锯HJ-3.5	350×φ3.5,分体式	1	把
33	ZQ4087RB	手术器械手柄SB-T	58,T型	1	把
34	ZQ4094RB	扩孔器	250×φ6	1	把

扩孔器  
Dilator, cannulated



- ★ ZQ3043RN 200×φ5
- ★ ZQ3044RN 185×φ7
- ★ ZQ3045RN 170×φ9
- ★ ZQ3046RN 155×φ11
- ★ ZQ3047RN 140×φ13
- ★ ZQ3048RN 125×φ15

扩孔器(实心)  
Dilator



- ZQ3039RN 150×φ5
- ZQ3040RN 150×φ11
- ZQ3041RN 150×φ13
- ZQ3042RN 150×φ15

骨定位针  
Guiding Pin



- ★ ZQ3003RN 210×φ5

骨锤  
Bone Mallet



- ★ ZQ3004RN 225/140g

骨刀  
Gouge

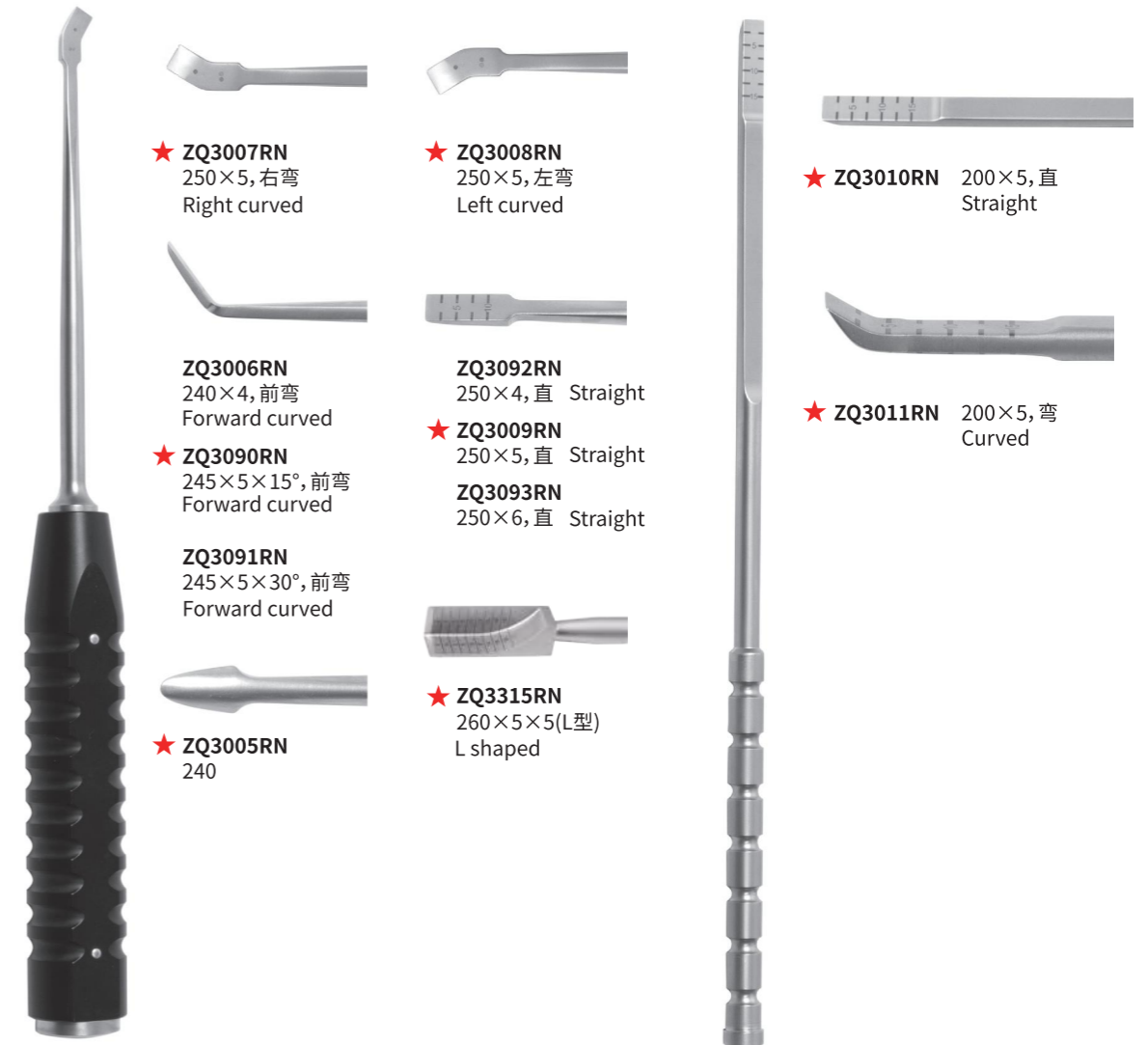

- ★ ZQ3007RN 250×5, 右弯  
Right curved

- ★ ZQ3008RN 250×5, 左弯  
Left curved

- ★ ZQ3010RN 200×5, 直  
Straight

- ZQ3006RN 240×4, 前弯  
Forward curved

- ZQ3092RN 250×4, 直  
Straight

- ★ ZQ3090RN 245×5×15°, 前弯  
Forward curved

- ★ ZQ3009RN 250×5, 直  
Straight

- ★ ZQ3011RN 200×5, 弯  
Curved

- ZQ3093RN 250×6, 直  
Straight

- ZQ3091RN 245×5×30°, 前弯  
Forward curved

- ★ ZQ3005RN 240

- ★ ZQ3315RN 260×5×5(L型)  
L shaped

骨刮匙  
Bone Curette



- ★ ZQ3013RN 260×3×30°,前弯 Forward curved
- ★ ZQ3014RN 260×5×30°,前弯 Forward curved
- ★ ZQ3015RN 260×6×30°,前弯 Forward curved



- ★ ZQ3016RN 260×3×45°,反口 Reverse opening
- ★ ZQ3060RN 260×6×45°,反口 Reverse opening



- ★ ZQ3017RN 230×3×130°,前弯 Forward curved

创口钩(半套管牵开器)  
Retractor



- ★ ZQ3056RN 50×12.5
- ★ ZQ3057RN 60×12.5
- ★ ZQ3058RN 70×12.5
- ★ ZQ3059RN 80×12.5

骨膜剥离器(肌肉剥离器)  
Muscle retractor



- ★ ZQ3037RN 165

骨膜剥离器(终板分离器)  
Periosteal Raspatory



- ★ ZQ3019RN 260×7×5°,弯 Curved



- ★ ZQ3020RN 260×7×25°,弯 Curved



- ZQ3097RN 220×9×45°,弯,方头 Curved

骨膜剥离器(双头剥离器)  
Periosteal Raspatory



- ZQ3300RN 300×1,深弯 Largely curved
- ★ ZQ3302RN 300×2,深弯 Largely curved
- ★ ZQ3032RN 300×3,深弯 Largely curved

- ZQ3030RN 300×4,深弯 Largely curved
- ZQ3028RN 300×5.5,深弯 Largely curved



- ZQ3099RN 300×1,微弯 Slightly curved
- ★ ZQ3301RN 300×2,微弯 Slightly curved
- ★ ZQ3031RN 300×3,微弯 Slightly curved

- ZQ3029RN 300×4,微弯 Slightly curved
- ZQ3027RN 300×5.5,微弯 Slightly curved

骨铰刀  
Reamer



- ZQ3305R N 230×4
- ZQ3306RN 230×5
- ★ ZQ3307RN 230×6
- ★ ZQ3038RN 230×8

显微钩(神经根剥离离子)  
Nerve Root Raspatory



- ★ ZQ3002RN 230×7
- ★ ZQ3095RN 230×5, 单头

神经根拉钩  
Nerve Root Retractor

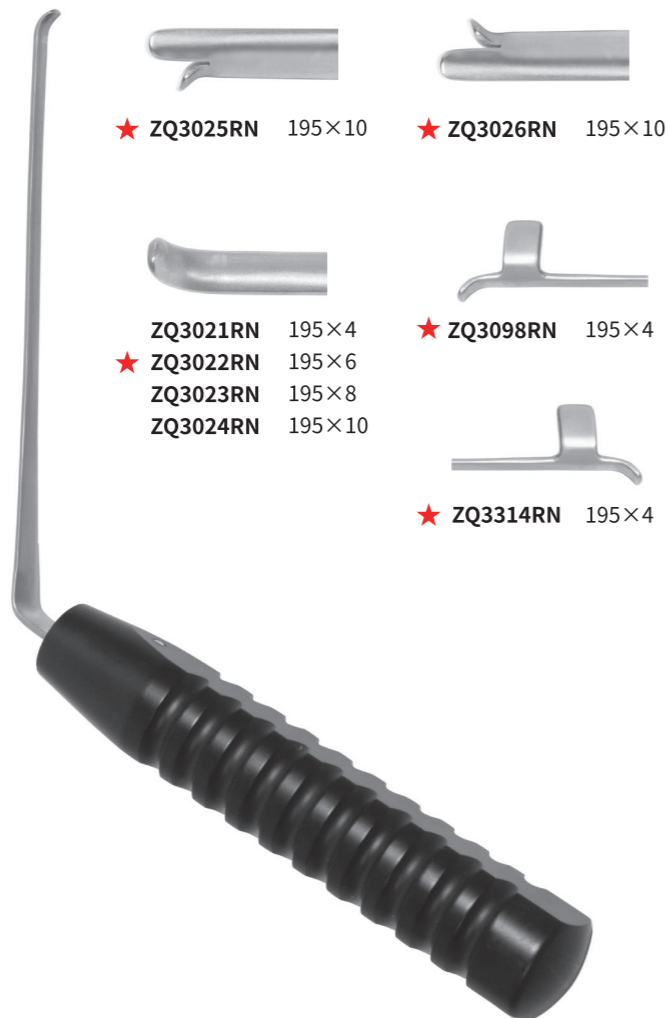

- ★ ZQ3025RN 195×10
- ★ ZQ3026RN 195×10
- ZQ3021RN 195×4
- ★ ZQ3098RN 195×4
- ★ ZQ3022RN 195×6
- ZQ3023RN 195×8
- ZQ3024RN 195×10
- ★ ZQ3314RN 195×4

双室漏斗  
Funnel



- ★ ZQ3061RN 165×φ8
- ZQ3109RN 165×φ6

植骨器(植骨推棒)  
Bone Grafting Impactor



- ★ ZQ3062RN 280×φ6.5
- ZQ3110RN 280×φ4.5

吸引管  
Suction Tube



- ★ ZQ3033RN 200×φ3, 弯



- ZQ3036RN 170×φ3, 弯

显微刀  
Micro Knife



★ ZQ3096RN 230

神经剥离器  
Nerve Raspatory



ZQ3001RN 230×5

植骨器(融合器打入器)  
Fusion Cage Impactor



★ ZQ3012RN 235

★ ZQ3094RN 235

骨用牵开器(弹簧撑开器)  
Bone Retractor



ZQ3050RN 35×10  
★ ZQ3051RN 50×10  
ZQ3052RN 50×20  
★ ZQ3053RN 60×20  
ZQ3054RN 70×20  
ZQ3055RN 80×20

护套管  
Sleeve



★ ZQ3311RN 40×φ7  
★ ZQ3312RN 50×φ7  
★ ZQ3313RN 60×φ7

椎板咬骨钳(旋转椎板咬骨钳)  
Kerrison Punch, Detachable



★ ZF3096RN 230×2/10×110°,可拆式  
★ ZF3097RN 230×3/10×110°,可拆式  
★ ZF3084RN 230×2/10×130°,可拆式  
★ ZF3085RN 230×3/10×130°,可拆式  
★ ZF3088RN 230×4/10×130°,可拆式

★ ZF3087RN 230×3/10×130°,可拆式,弧形  
★ ZF3086RN 230×2/10×130°,可拆式,弧形

髓核钳(精细型)  
Laminectomy Rongeur, fine



★ ZF3074RN 220×3,直型,握柄式  
ZF3078RN 220×4,直型,握柄式

★ ZF3075RN 220×3×150°,握柄式  
ZF3079RN 220×4×150°,握柄式

髓核钳  
Laminectomy Rongeur



★ ZF3089RN 230×2,直型,指圈式

★ ZF3090RN 230×2×150°,指圈式

髓核钳  
Laminectomy Rongeur

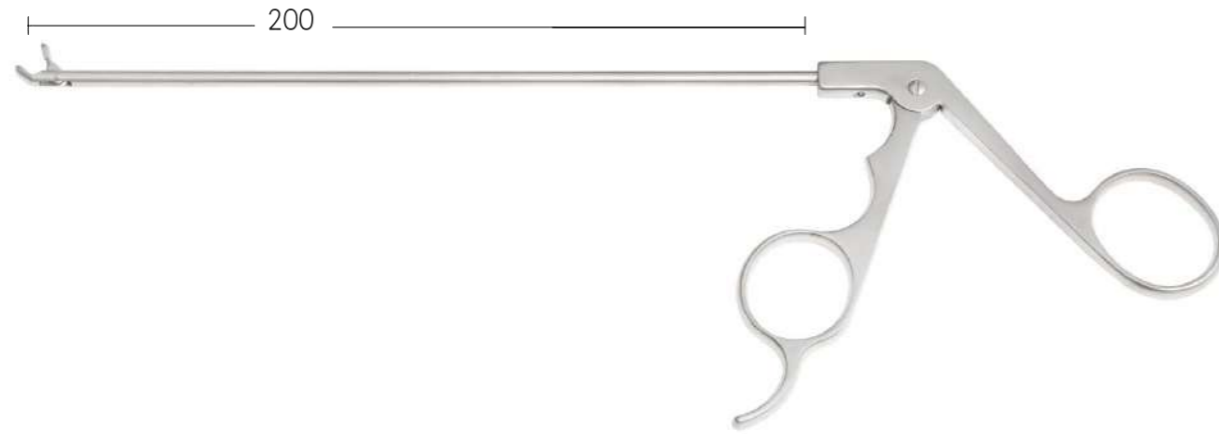

- ★ ZF3061RN 200×4, 直型, 指圈式
- ★ ZF3062RN 200×3, 直型, 指圈式
- ★ ZF3063RN 200×4×150°, 指圈式
- ★ ZF3064RN 200×3×150°, 指圈式
- ★ ZF3065RN 200×4, 尖状, 指圈式
- ★ ZF3066RN 200×3, 尖状, 指圈式
- ★ ZF3067RN 200×4×150°, 尖状, 指圈式
- ★ ZF3068RN 200×3×150°, 尖状, 指圈式



显微钳  
Micro cutting forceps

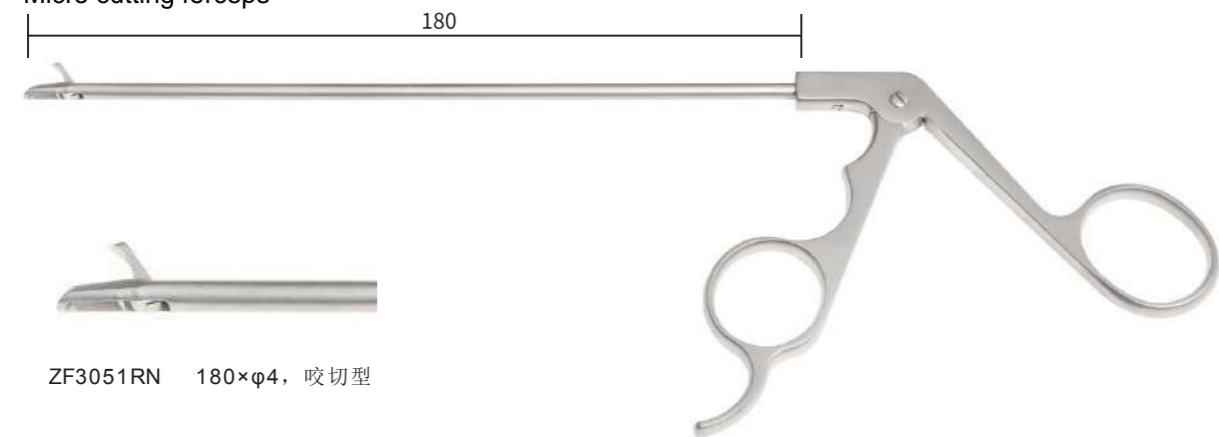

ZF3051RN 180×φ4, 咬切型



ZF3052RN 180×φ4×15°, 咬切型

×



JZWC- III 脊柱微创手术器械(ZQ2998)  
UBE Spine Surgery Set

序号	产品编码	产品名称	规格型号	数量	单位
1	ZQ3001RN	神经剥离器	230×5	1	把
2	ZQ3004RN	骨锤	225/140g	1	把
3	ZQ3005RN	骨刀	240	1	把
4	ZQ3091RN	骨刀	245×5×30°,前弯	1	把
5	ZQ3007RN	骨刀	250×5,右弯	1	把
6	ZQ3008RN	骨刀	250×5,左弯	1	把
7	ZQ3009RN	骨刀	250×5,直	1	把
8	ZQ3010RN	骨刀	200×5,直	1	把
9	ZQ3011RN	骨刀	200×5,弯	1	把
10	ZQ3012RN	植骨器	/	1	把
11	ZQ3013RN	骨刮匙	260×3×30°,前弯	1	把
12	ZQ3014RN	骨刮匙	260×5×30°,前弯	1	把
13	ZQ3016RN	骨刮匙	260×3×45°,反口	1	把
14	ZQ3095RN	显微钩	230×5,单头	1	把
15	ZQ3096RN	显微刀	230	1	把
16	ZQ3020RN	骨膜剥离器	260×7×25,弯	1	把
17	ZQ3097 RN	骨膜剥离器	220×9×45°,弯,方头	1	把
18	ZQ3098RN	神经根拉钩	195×4	1	把

序号	产品编码	产品名称	规格型号	数量	单位
19	ZQ3021 RN	神经根拉钩	195×4	1	把
20	ZQ3022RN	神经根拉钩	195×6	1	把
21	ZQ3023RN	神经根拉钩	195×8	1	把
22	ZQ3031 RN	骨膜剥离器	300×3,微弯	1	把
23	ZQ3032RN	骨膜剥离器	300×3,深弯	1	把
24	ZQ3033RN	吸引管	200×φ3,弯	1	把
25	ZQ3038RN	骨铰刀	230×8	1	把
26	ZQ3043RN	扩孔器	200×φ5	1	把
27	ZQ3044RN	扩孔器	185×φ7	1	把
28	ZQ3045RN	扩孔器	170×φ9	1	把
29	ZQ3046RN	扩孔器	155×φ11	1	把
30	ZQ3047RN	扩孔器	140×φ13	1	把
31	ZQ3056RN	创口钩	50×12.5	1	把
32	ZQ3057RN	创口钩	60×12.5	1	把
33	ZQ3058RN	创口钩	70×12.5	1	把
34	Z03059RN	创口钩	80×12.5	1	把
35	ZQ3061RN	双室漏斗	165×φ8	1	把
36	ZQ3062RN	植骨器	280×φ6.5	1	把
37	ZF3084RN	椎板咬骨钳	230×2/10×130°,可拆式	1	把
38	ZF3085RN	椎板咬骨钳	230×3/10×130°,可拆式	1	把
39	ZF3087RN	椎板咬骨钳	230×3/10×130°,可拆式,弧形	1	把
40	ZF3088RN	椎板咬骨钳	230×4/10×130°,可拆式	1	把
41	ZF3089RN	髓核钳	230×2,直型,指圈式	1	把
42	ZF3090RN	髓核钳	230×2×150°,指圈式	1	把
43	ZF3074RN	髓核钳	220×3,直型,握柄式	1	把
44	ZF3075RN	髓核钳	220×3×150°,握柄式	1	把
45	ZF3078RN	髓核钳	220×4,直型,握柄式	1	把



JZWC-I 脊柱微创手术器械 (ZQ3000)  
UBE Spine Surgery Set

序号	产品编码	产品名称	规格型号	数量	单位
1	ZQ3001RN	神经剥离器	230×5	1	把
2	ZQ3002RN	显微钩	230×7	1	把
3	ZQ3003RN	骨定位针	210×φ5	1	把
4	ZQ3004RN	骨锤	225/140g	1	把
5	ZQ3005RN	骨刀	240	1	把
6	ZQ3006RN	骨刀	240×4, 前弯	1	把
7	ZQ3007RN	骨刀	250×5, 右弯	1	把
8	ZQ3008RN	骨刀	250×5, 左弯	1	把
9	ZQ3009RN	骨刀	250×5, 直	1	把
10	ZQ3010RN	骨刀	200×5, 直	1	把
11	ZQ3011RN	骨刀	200×5, 弯	1	把
12	ZQ3012RN	植骨器	/	1	把
13	ZQ3013RN	骨刮匙	260×3×30°, 前弯	1	把
14	ZQ3014RN	骨刮匙	260×5×30°, 前弯	1	把
15	ZQ3015RN	骨刮匙	260×6×30°, 前弯	1	把
16	ZQ3016RN	骨刮匙	260×3×45°, 反口	1	把
17	ZQ3017RN	骨刮匙	230×3×130°, 前弯	1	把
18	ZQ1257RN	神经剥离器	240×5, 带钩	1	把
19	ZQ3019RN	骨膜剥离器	260×7×5°, 弯	1	把
20	ZQ3020RN	骨膜剥离器	260×7×25°, 弯	1	把

序号	产品编码	产品名称	规格型号	数量	单位
21	ZQ3021RN	神经根拉钩	195×4	1	把
22	ZQ3022RN	神经根拉钩	195×6	1	把
23	ZQ3023RN	神经根拉钩	195×8	1	把
24	ZQ3024RN	神经根拉钩	195×10	1	把
25	ZQ3025RN	神经根拉钩	195×10	1	把
26	ZQ3026RN	神经根拉钩	195×10	1	把
27	ZQ3031RN	骨膜剥离器	300×3, 微弯	1	把
28	ZQ3032RN	骨膜剥离器	300×3, 深弯	1	把
29	ZQ3033RN	吸引管	200×φ3, 弯	1	支
30	ZQ3036RN	吸引管	170×φ3, 弯	1	支
31	ZQ3037RN	骨膜剥离器	165	1	把
32	ZQ3038RN	骨铰刀	230×8	1	把
33	ZQ3039RN	扩孔器	150×φ5	1	把
34	ZQ3040RN	扩孔器	150×φ11	1	把
35	ZQ3041RN	扩孔器	150×φ13	1	把
36	ZQ3042RN	扩孔器	150×φ15	1	把
37	ZQ3043RN	扩孔器	200×φ5	1	把
38	ZQ3044RN	扩孔器	185×φ7	1	把
39	ZQ3045RN	扩孔器	170×φ9	1	把
40	ZQ3046RN	扩孔器	155×φ11	1	把
41	ZQ3047RN	扩孔器	140×φ13	1	把
42	ZQ3048RN	扩孔器	125×φ15	1	把
43	ZQ3049RN	扩孔器	200×φ7	1	把
44	ZQ3056RN	创口钩	50×12.5	1	把
45	ZQ3057RN	创口钩	60×12.5	1	把
46	ZQ3058RN	创口钩	70×12.5	1	把
47	ZQ3059RN	创口钩	80×12.5	1	把
48	ZQ3060RN	骨刮匙	260×6×45°, 反口	1	把
49	ZQ3061RN	双室漏斗	165×φ8	1	把
50	ZQ3062RN	植骨器	280×φ6.5	1	把



双通道脊柱手术器械推荐配置 (ZQ2999)  
UBE Spine Surgery Set

序号	产品编码	产品名称	规格型号	数量	单位
1	ZQ3001RN	ZQ3001RN 神经剥离器	230×5	1	把
2	ZQ3004RN	ZQ3004RN 骨锤	225/140g	1	把
3	ZQ3005RN	ZQ3005RN 骨刀	240	1	把
4	ZQ3090RN	ZQ3090RN 骨刀	245×5×15°, 前弯	1	把
5	ZQ3091RN	ZQ3091RN 骨刀	245×5×30°, 前弯	1	把
6	ZQ3007RN	ZQ3007RN 骨刀	250×5, 右弯	1	把
7	ZQ3008RN	ZQ3008RN 骨刀	250×5, 左弯	1	把
8	ZQ3092RN	ZQ3092RN 骨刀	250×4, 直	1	把
9	ZQ3009RN	ZQ3009RN 骨刀	250×5, 直	1	把
10	ZQ3093RN	ZQ3093RN 骨刀	250×6, 直	1	把
11	ZQ3010RN	ZQ3010RN 骨刀	200×5, 直	1	把
12	ZQ3011RN	ZQ3011RN 骨刀	200×5, 弯	1	把
13	ZQ3094RN	ZQ3094RN 植骨器	235	1	把
14	ZQ3013RN	ZQ3013RN 骨刮匙	260×3×30°, 前弯	1	把
15	ZQ3014RN	ZQ3014RN 骨刮匙	260×5×30°, 前弯	1	把

序号	产品编码	产品名称	规格型号	数量	单位
16	ZQ3015RN	ZQ3015RN 骨刮匙	260×6×30°, 前弯	1	把
17	ZQ3016RN	ZQ3016RN 骨刮匙	260×3×45°, 反口	1	把
18	ZQ3095RN	ZQ3095RN 显微钩	230×5, 单头	1	把
19	ZQ3096RN	ZQ3096RN 显微刀	230	1	把
20	ZQ3019RN	ZQ3019RN 骨膜剥离器	260×7×5°, 弯	1	把
21	ZQ3020RN	ZQ3020RN 骨膜剥离器	260×7×25°, 弯	1	把
22	ZQ3097RN	ZQ3097RN 骨膜剥离器	220×9×45°, 弯, 方头	1	把
23	ZQ3098RN	ZQ3098RN 神经根拉钩	195×4	1	把
24	ZQ3021RN	ZQ3021RN 神经根拉钩	195×4	1	把
25	ZQ3022RN	ZQ3022RN 神经根拉钩	195×6	1	把
26	ZQ3023RN	ZQ3023RN 神经根拉钩	195×8	1	把
27	ZQ3099RN	ZQ3099RN 骨膜剥离器	300×1, 微弯	1	把
28	ZQ3300RN	ZQ3300RN 骨膜剥离器	300×1, 深弯	1	把
29	ZQ3301RN	ZQ3301RN 骨膜剥离器	300×2, 微弯	1	把
30	ZQ3302RN	ZQ3302RN 骨膜剥离器	300×2, 深弯	1	把
31	ZQ3031RN	ZQ3031RN 骨膜剥离器	300×3, 微弯	1	把
32	ZQ3032RN	ZQ3032RN 骨膜剥离器	300×3, 深弯	1	把
33	ZQ3029RN	ZQ3029RN 骨膜剥离器	300×4, 微弯	1	把
34	ZQ3030RN	ZQ3030RN 骨膜剥离器	300×4, 深弯	1	把
35	ZQ3033RN	ZQ3033RN 吸引管	200×φ3, 弯	1	把
36	ZQ3305RN	ZQ3305RN 骨铰刀	230×4	1	把
37	ZQ3306RN	ZQ3306RN 骨铰刀	230×5	1	把
38	ZQ3307RN	ZQ3307RN 骨铰刀	230×6	1	把
39	ZQ3038RN	ZQ3038RN 骨铰刀	230×8	1	把
40	ZQ3040RN	ZQ3040RN 扩孔器	150×φ11	1	把
41	ZQ3041RN	ZQ3041RN 扩孔器	150×φ13	1	把
42	ZQ3042RN	ZQ3042RN 扩孔器	150×φ15	1	把
43	ZQ3043RN	ZQ3043RN 扩孔器	200×φ5	1	把
44	ZQ3044RN	ZQ3044RN 扩孔器	185×φ7	1	把
45	ZQ3045RN	ZQ3045RN 扩孔器	170×φ9	1	把
46	ZQ3046RN	ZQ3046RN 扩孔器	155×φ11	1	把
47	ZQ3049RN	ZQ3049RN 扩孔器	200×φ7	1	把
48	ZQ3308RN	ZQ3308RN 扩孔器	150×φ7	1	把
49	ZQ3309RN	ZQ3309RN 扩孔器	150×φ9	1	把
50	ZQ3056RN	ZQ3056RN 创口钩	50×12.5	1	把

序号	产品编码	产品名称	规格型号	数量	单位
51	ZQ3057RN	ZQ3057RN 创口钩	60×12.5	1	把
52	ZQ3058RN	ZQ3058RN 创口钩	70×12.5	1	把
53	ZQ3059RN	ZQ3059RN 创口钩	80×12.5	1	把
54	ZQ3060RN	ZQ3060RN 骨刮匙	260×6×45°, 反口	1	把
55	ZQ3061RN	ZQ3061RN 双室漏斗	165×φ8	1	把
56	ZQ3062RN	ZQ3062RN 植骨器	280×φ6.5	1	把
57	ZQ3311RN	ZQ3311RN 护套	φ7×40	1	把
58	ZQ3312RN	ZQ3312RN 护套	φ7×50	1	把
59	ZQ3313RN	ZQ3313RN 护套	φ7×60	1	把
60	ZF3084RN	ZF3084RN 椎板咬骨钳	230×2/10×130°, 可拆式	1	把
61	ZF3085RN	ZF3085RN 椎板咬骨钳	230×3/10×130°, 可拆式	1	把
62	ZF3086RN	ZF3086RN 椎板咬骨钳	230×2/10×130°, 可拆式, 弧形	1	把
63	ZF3087RN	ZF3087RN 椎板咬骨钳	230×3/10×130°, 可拆式, 弧形	1	把
64	ZF3088RN	ZF3088RN 椎板咬骨钳	230×4/10×130°, 可拆式	1	把
65	ZF3089RN	ZF3089RN 髓核钳	230×2, 直型, 指圈式	1	把
66	ZF3090RN	ZF3090RN 髓核钳	230×2×150°, 指圈式	1	把
67	ZF3074RN	ZF3074RN 髓核钳	220×3, 直型, 握柄式	1	把
68	ZF3075RN	ZF3075RN 髓核钳	220×3×150°, 握柄式	1	把
69	ZF3078RN	ZF3078RN 髓核钳	220×4, 直型, 握柄式	1	把

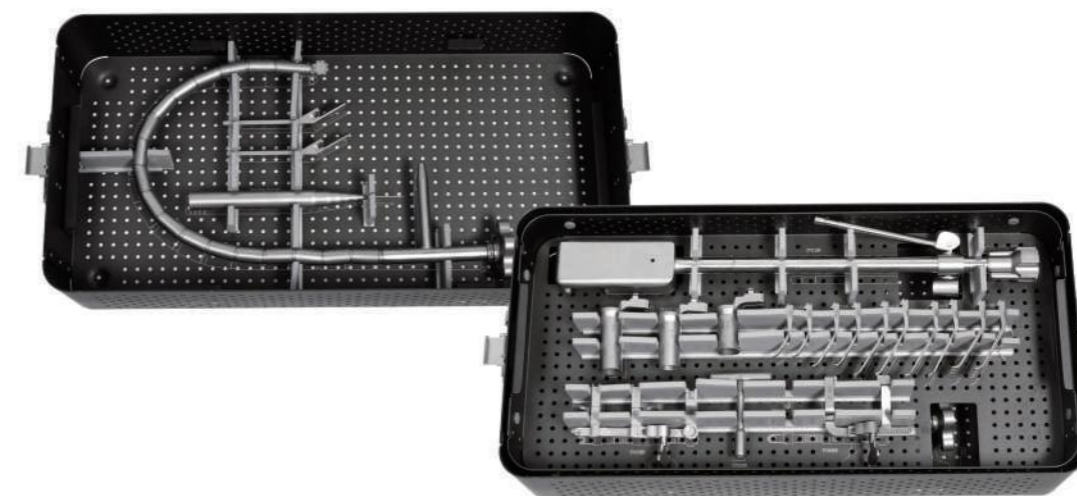

骨用牵开器 (ZV450RN)  
Bone Retractor

序号	产品编码	产品名称	规格型号	数量	单位
1	ZV451RN	软轴牵开器	740×φ17.5	1	套
2	ZV453RN	骨用牵开器	130×57	1	套
3	ZV454RN	骨用牵开器	95×64	1	件
4	ZV455RN	扩孔器	140×φ21.5	1	件
5	ZV456RN	扩孔器	150×φ19	1	件
6	ZV457RN	扩孔器	160×φ16	1	件
7	ZV458RN	扩孔器	170×φ13	1	件
8	ZV459RN	扩孔器	180×φ10	1	件
9	ZV460RN	扩孔器	190×φ6.5	1	件
10	ZV461RN	扩孔器	234×φ2	1	件

可扩张脊柱微创牵开系统





骨用牵开器 (ZV480RN)  
Bone Retractor

序号	产品编码	产品名称	规格型号	数量	单位
1	ZV451RN	软轴牵开器	740×Φ17.5	1	条
2	ZV481RN	椎间盘窥镜	Φ18×Φ14×40	1	件
3	ZV482RN	椎间盘窥镜	Φ18×Φ14×50	1	件
4	ZV483RN	椎间盘窥镜	Φ18×Φ14×60	1	件
5	ZV484RN	椎间盘窥镜	Φ22×Φ18×40	1	件
6	ZV485RN	椎间盘窥镜	Φ22×Φ18×50	1	件
7	ZV486RN	椎间盘窥镜	Φ22×Φ18×60	1	件
8	ZV487RN	椎间盘窥镜	Φ18×40	1	件
9	ZV488RN	椎间盘窥镜	Φ18×50	1	件
10	ZV489RN	椎间盘窥镜	Φ18×60	1	件
11	ZV490RN	椎间盘窥镜	Φ22×40	1	件
12	ZV491RN	椎间盘窥镜	Φ22×50	1	件
13	ZV492RN	椎间盘窥镜	Φ22×60	1	件
14	ZV493RN	扩孔器	150×Φ22	1	件
15	ZV494RN	扩孔器	160×Φ18	1	件
16	ZV495RN	扩孔器	170×Φ13	1	件
17	ZV496RN	扩孔器	230×Φ8	1	件



脊柱微创固定通道系统

颈椎牵开器 (JV320)  
Cervical Retractor

★ JV321T 左侧 Left

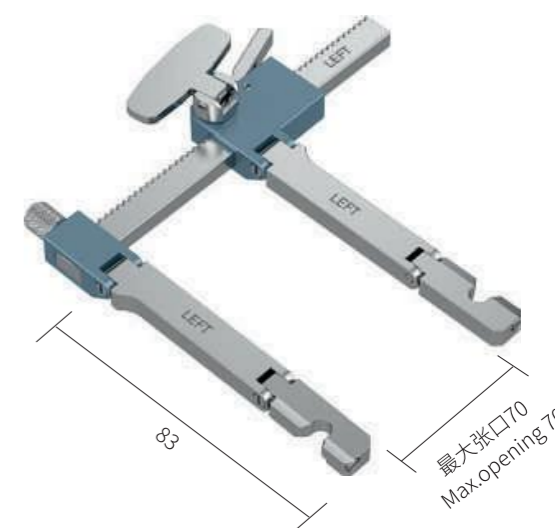

颈椎牵开器 (JV320)  
Cervical Retractor

★ JV322T 右侧 Right

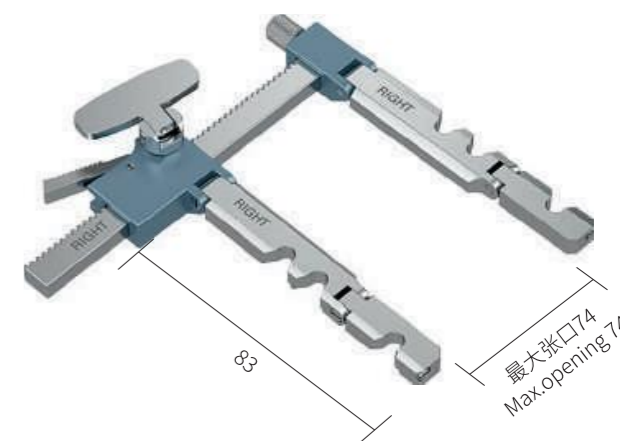

颈椎牵开器 (JV320)  
Cervical Retractor

★ JV323T 右侧 Right,offset

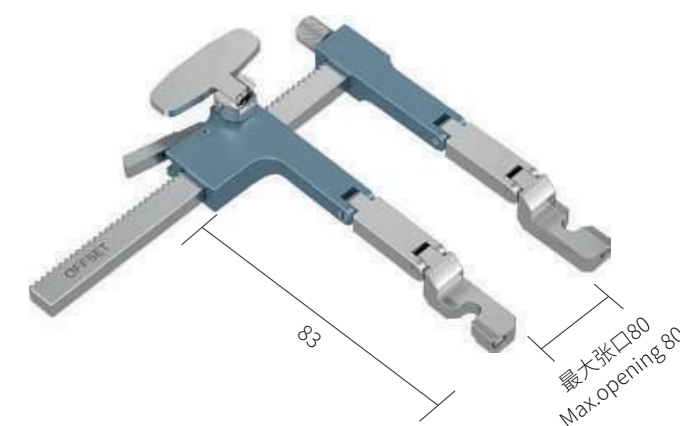

手柄  
Handle

★ JV324RB



手柄  
Handle

JV325RN



拉钩  
Blade

- JV326T 34×22.5, 有齿
- JV327T 40×22.5, 有齿
- ★ JV328T 45×22.5, 有齿
- ★ JV329T 50×22.5, 有齿
- ★ JV330T 55×22.5, 有齿
- ★ JV331T 60×22.5, 有齿
- JV332T 70×22.5, 有齿
- JV333T 85×22.5, 有齿

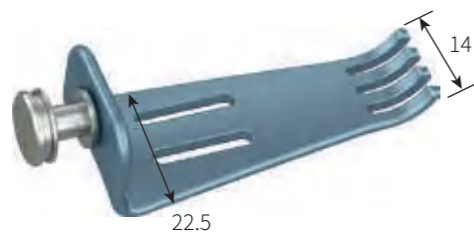

拉钩  
Blade

- JV334T 34×22.5, 无齿
- ★ JV335T 40×22.5, 无齿
- ★ JV336T 45×22.5, 无齿
- ★ JV337T 50×22.5, 无齿
- ★ JV338T 55×22.5, 无齿
- ★ JV339T 60×22.5, 无齿
- JV340T 70×22.5, 无齿

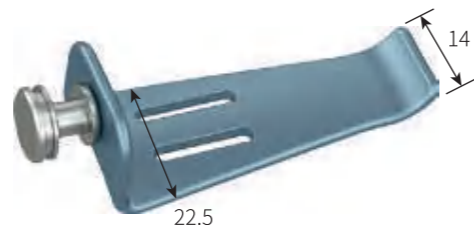

拉钩  
Blade

- JV341T 40×26.5, 有齿
- JV342T 47×26.5, 有齿
- ★ JV343T 55×26.5, 有齿



拉钩  
Blade

- JV344T 40×26.5, 无齿
- JV345T 47×26.5, 无齿
- ★ JV346T 55×26.5, 无齿



测深器  
Depth Gauge

★ JV347T



加长齿条  
Extension Rack

JV315T 160



拉钩  
Retractor

JV316T 尖型



拉钩  
Retractor

JV317T T型



拉钩  
Retractor

JV318T 椭圆型



锁紧器  
Locker

JV319T 33



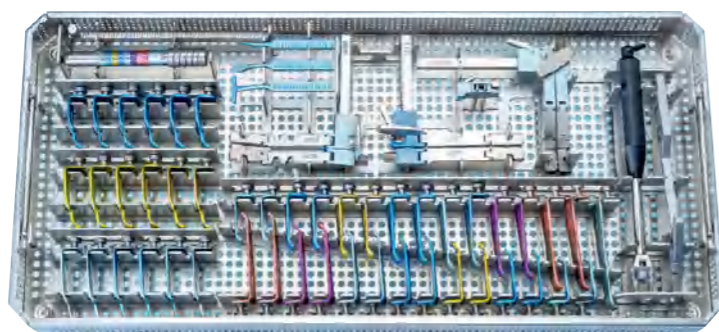

★ 颈椎牵开器 (JV320)  
Cervical Retractor Set (JV320)

序号	编码	名称	规格	数量
1	JV321T	颈椎牵开器	左侧	1
2	JV322T	颈椎牵开器	右侧	1
3	JV323T	颈椎牵开器	右侧	1
4	JV324RB	手柄		1
5	JV325RN	手柄		1
6	JV326T	拉钩	34X22,5,有齿	2
7	JV327T	拉钩	40X22,5,有齿	2
8	JV328T	拉钩	45X22,5,有齿	2
9	JV329T	拉钩	50X22,5,有齿	2
10	JV330T	拉钩	55X22,5,有齿	2
11	JV331T	拉钩	60X22,5,有齿	2
12	JV332T	拉钩	70X22,5,有齿	2
13	JV333T	拉钩	85X22,5,有齿	1
14	JV334T	拉钩	34X22,5,无齿	2
15	JV335T	拉钩	40X22,5,无齿	2
16	JV336T	拉钩	45X22,5,无齿	2
17	JV337T	拉钩	50X22,5,无齿	2
18	JV338T	拉钩	55X22,5,无齿	2
19	JV339T	拉钩	60X22,5,无齿	2
20	JV340T	拉钩	70X22,5,无齿	2
21	JV341T	拉钩	40X26,5,有齿	4
22	JV342T	拉钩	47X26,5,有齿	4
23	JV343T	拉钩	55X26,5,有齿	4
24	JV344T	拉钩	40X26,5,无齿	2
25	JV345T	拉钩	47X26,5,无齿	2
26	JV346T	拉钩	55X26,5,无齿	2
27	JV347T	测深器		1
28	JV315T	加长齿条		1
29	JV316T	拉钩	尖型	1
30	JV317T	拉钩	T型	1
31	JV318T	拉钩	椭圆形	1
32	JV319T	锁紧器		1

颈椎牵开器  
Cervical Retractor

★ ZV321RNh 左侧 Left

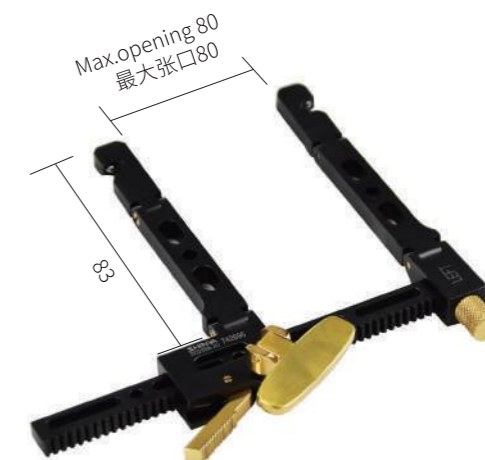

颈椎牵开器  
Cervical Retractor

★ ZV322RNh 右侧 Right

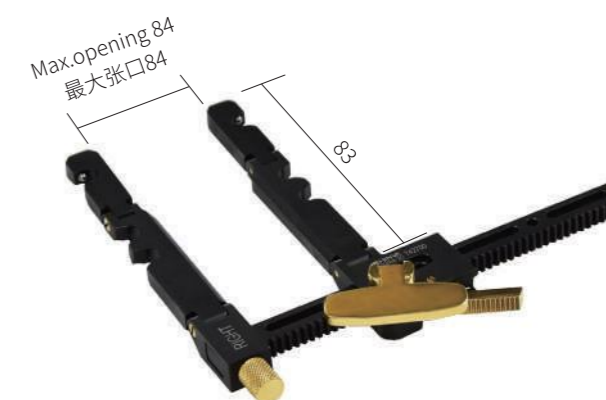

颈椎牵开器  
Cervical Retractor

★ ZV323RNh 右侧 Right, offse

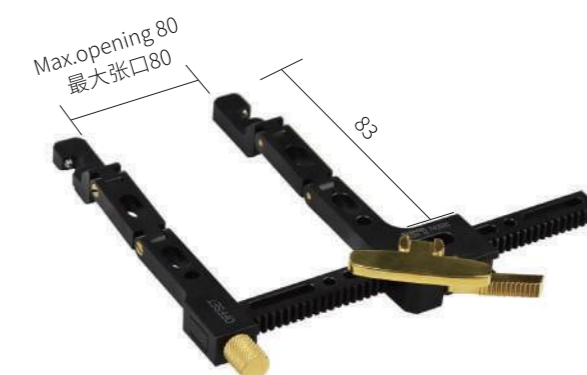

组合方式示意图  
Combination diagram

快装手柄  
Quick coupling handle



ZV324RN 200

拉钩  
Blade

L

- ZV326RNh 35×20;带齿
- ★ ZV328RNh 45×20;带齿
- ★ ZV330RNh 55×20;带齿
- ZV332RNh 70×20;带齿



拉钩  
Blade

L B

- ZV334RNh 35×20
- ★ ZV336RNh 45×20
- ★ ZV338RNh 55×20
- ZV340RNh 70×20
- ★ ZV345RNh 45×16
- ★ ZV346RNh 55×16
- ZV348RNh 35×16
- ZV349RNh 70×16

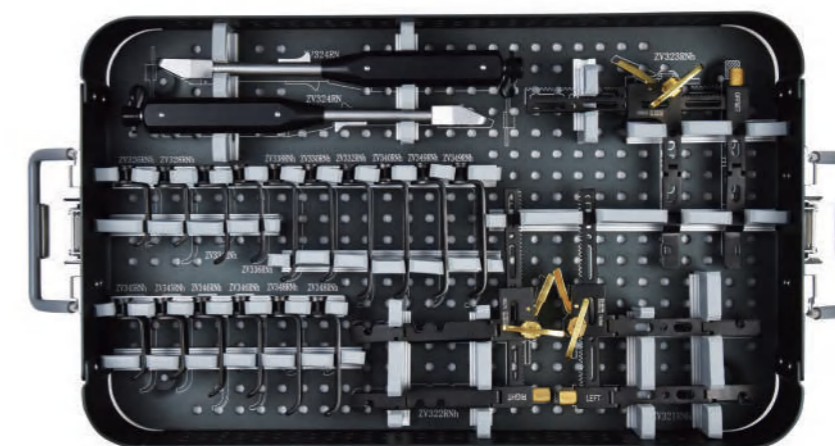
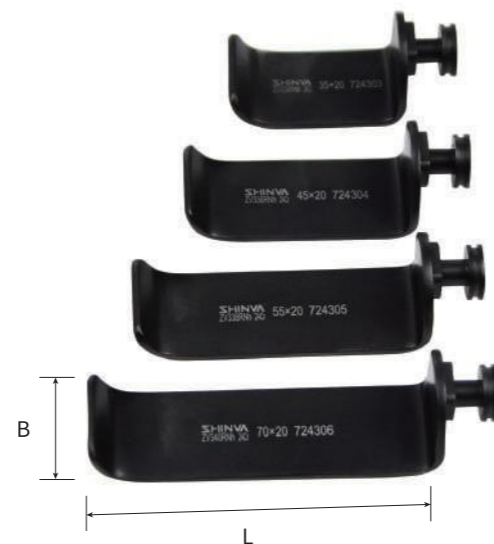

颈椎牵开器 (ZV320)  
Cervical Retractor Set(ZV320)

序号	产品编码	产品名称	规格型号	数量	单位
1	ZV321RNh	颈椎牵开器	左侧	1	把
2	ZV322RNh	颈椎牵开器	右侧	1	把
3	ZV323RNh	颈椎牵开器	右侧	1	把
4	ZV324RN	快装手柄	200	2	把
5	ZV326RNh	拉钩	35×20;带齿	1	把
6	ZV328RNh	拉钩	45×20;带齿	1	把
7	ZV330RNh	拉钩	55×20;带齿	1	把
8	ZV332RNh	拉钩	70×20;带齿	1	把
9	ZV334RNh	拉钩	35×20	1	把
10	ZV336RNh	拉钩	45×20	1	把
11	ZV338RNh	拉钩	55×20	1	把
12	ZV340RNh	拉钩	70×20	1	把
13	ZV345RNh	拉钩	45×16	2	把
14	ZV346RNh	拉钩	55×16	2	把
15	ZV348RNh	拉钩	35×16	2	把
16	ZV349RNh	拉钩	70×16	2	把

腰椎牵开器  
Lumbar Retractor

★ JV351RNh



拉钩  
Retractor

- JV352RNh 30×20
- ★ JV353RNh 40×20
- ★ JV354RNh 50×20
- ★ JV355RNh 60×20
- ★ JV356RNh 70×20
- JV357RNh 80×20



拉钩  
Retractor

- JV358RNh 30×27
- ★ JV359RNh 40×27
- ★ JV360RNh 50×27
- ★ JV361RNh 60×27
- ★ JV362RNh 70×27
- JV363RNh 80×27



拉钩  
Retractor

- JV364RNh 20×2, 钩型, 有齿
- JV365RNh 30×2, 钩型, 有齿
- JV366RNh 40×2, 钩型, 有齿
- JV367RNh 50×2, 钩型, 有齿
- JV368RNh 60×2, 钩型, 有齿
- JV369RNh 70×2, 钩型, 有齿



拉钩  
Retractor

- JV370RNh 20×1.8, 钩型, 无齿
- JV371RNh 30×1.8, 钩型, 无齿
- JV372RNh 40×1.8, 钩型, 无齿
- JV373RNh 50×1.8, 钩型, 无齿
- JV374RNh 60×1.8, 钩型, 无齿
- JV375RNh 70×1.8, 钩型, 无齿



碳纤维腰椎牵开器  
Lumbar Retractor Carbon Fiber

★ JV901P



拉钩  
Retractor

- ★ JV902P 40×20
- ★ JV903P 50×20
- ★ JV904P 60×20
- ★ JV905P 70×20



拉钩  
Retractor

- JV906P 30×27
- ★ JV907P 40×27
- ★ JV908P 50×27
- ★ JV909P 60×27
- ★ JV910P 70×27





★ 腰椎牵开器 (JV350)  
Lumbar Retractor Set (JV350)

序号	编 码	名 称	规 格	数量
1	JV351RNh	腰椎牵开器		2
2	JV352RNh	拉钩	30X20	2
3	JV353RNh	拉钩	40X20	2
4	JV354RNh	拉钩	50X20	2
5	JV355RNh	拉钩	60X20	2
6	JV356RNh	拉钩	70X20	2
7	JV357RNh	拉钩	80X20	2
8	JV358RNh	拉钩	30X27	2
9	JV359RNh	拉钩	40X27	2
10	JV360RNh	拉钩	50X27	2
11	JV361RNh	拉钩	60X27	2
12	JV362RNh	拉钩	70X27	2
13	JV363RNh	拉钩	80X27	2
14	JV364RNh	拉钩	20X2,钩型,有齿	1
15	JV365RNh	拉钩	30X2,钩型,有齿	1
16	JV366RNh	拉钩	40X2,钩型,有齿	1
17	JV367RNh	拉钩	50X2,钩型,有齿	1
18	JV368RNh	拉钩	60X2,钩型,有齿	1
19	JV369RNh	拉钩	70X2,钩型,有齿	1
20	JV370RNh	拉钩	20X1.8,钩型,无齿	1
21	JV371RNh	拉钩	30X1.8,钩型,无齿	1
22	JV372RNh	拉钩	40X1.8,钩型,无齿	1
23	JV373RNh	拉钩	50X1.8,钩型,无齿	1
24	JV374RNh	拉钩	60X1.8,钩型,无齿	1
25	JV375RNh	拉钩	70X1.8,钩型,无齿	1



★ 碳纤维腰椎牵开器 (JV900)  
Carbon Fiber Lumbar Retractor (JV900)

序号	编 码	名 称	规 格	数量
1	JV901P	腰椎牵开器		1
2	JV902P	拉钩	40X20	2
3	JV903P	拉钩	50X20	2
4	JV904P	拉钩	60X20	2
5	JV905P	拉钩	70X20	2
6	JV906P	拉钩	30X27	2
7	JV907P	拉钩	40X27	2
8	JV908P	拉钩	50X27	2
9	JV909P	拉钩	60X27	2
10	JV910P	拉钩	70X27	2

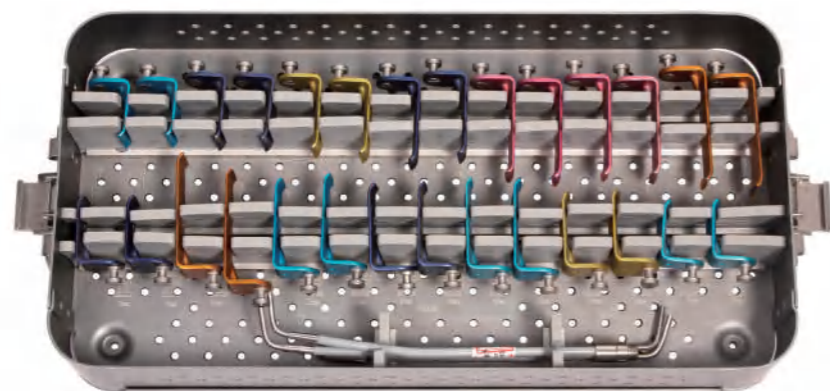

颈椎光源牵开器成套配置清单  
Cervical Light Source Retractor Set

序号	产品编码	产品名称	规格型号	数量	单位
1	JV470RN	拉钩	35×23, 带齿	2	把
2	JV471RN	拉钩	40×23, 带齿	2	把
3	JV472RN	拉钩	45×23, 带齿	2	把
4	JV473RN	拉钩	50×23, 带齿	2	把
5	JV474RN	拉钩	55×23, 带齿	2	把
6	JV475RN	拉钩	60×23, 带齿	2	把
7	JV476RN	拉钩	70×23, 带齿	2	把
8	JV477RN	拉钩	35×23	2	把
9	JV478RN	拉钩	40×23	2	把
10	JV479RN	拉钩	45×23	2	把
11	JV480RN	拉钩	50×23	2	把
12	JV481RN	拉钩	55×23	2	把
13	JV482RN	拉钩	60×23	2	把
14	JV483RN	拉钩	70×23	2	把

注: 选配牵开臂 JV321T( 优先 ), JV322T, JV323T; 光纤: ZV484R( 双头 ), ZV485R( 单头 ); 冷光源: ZV486R。

Remark:JV321T(Priority),JV322T,JV323T;Optical Fiber:ZV484R(Double End),ZV485(Single End); Cold Light Source:ZV486R.

椎间盘窥镜  
Intervertebral Disc Speculum

- ZV777RNh 40mm
- ZV778RNh 45mm
- ZV779RNh 50mm
- ZV780RNh 55mm
- ZV781RNh 60mm
- ZV782RNh 65mm
- ZV783RNh 75mm
- ZV784RNh 85mm



腰椎牵开器  
Lumbar Retractor

- ★ ZV760RN 齿条式, 双关节



拉钩(外侧)  
Blade

- |            |      |
|------------|------|
|            | H    |
| ZV761RNh   | 35mm |
| ZV762RNh   | 40mm |
| ZV763RNh   | 45mm |
| ZV764RNh   | 50mm |
| ★ ZV765RNh | 55mm |
| ★ ZV766RNh | 60mm |
| ★ ZV767RNh | 65mm |
| ★ ZV768RNh | 75mm |
| ZV769RNh   | 85mm |



拉钩(内侧)  
Blade with fixation screw

- |            |            |
|------------|------------|
|            | H          |
| ZV770RNh   | 40mm 带固定螺钉 |
| ZV771RNh   | 45mm 带固定螺钉 |
| ZV772RNh   | 50mm 带固定螺钉 |
| ★ ZV773RNh | 55mm 带固定螺钉 |
| ★ ZV774RNh | 60mm 带固定螺钉 |
| ★ ZV775RNh | 65mm 带固定螺钉 |
| ★ ZV776RNh | 70mm 带固定螺钉 |

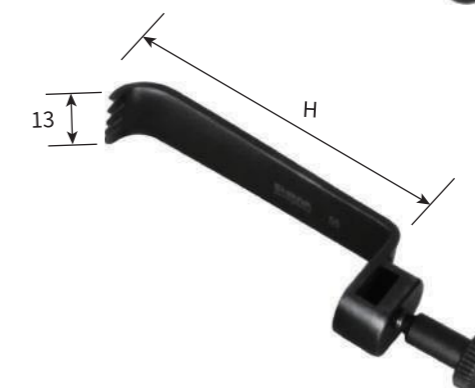

骨刮匙  
Cervical Bone Curette aluminum handle



★ ZQ1106RNh 250×2×45°,单弯,后,枪状,颈椎型,铝合金柄

骨刮匙  
Cervical Bone Curette aluminum handle



★ ZQ1107RNh 250×2,直头,枪状,颈椎型,铝合金柄

髓核钳  
Laminectomy Rongeur



★ ZF821RNh 180×2×10,指圈式

椎板咬骨钳  
Kerrison Punch thin footplate



★ ZF485RNsh 200×2/10×130°,超硬膜,超薄型  
★ ZF661RNdh 200×1/10×130°,超硬膜,超薄型

神经剥离器  
Cervical Raspatory



★ ZQ1248RNh 240×5×φ0.8,带钩,带槽,颈椎型 With groove

神经剥离器  
Raspatory



★ ZQ1249RNh 210×6×φ1.2,90°

咬骨钳  
Bone Rongeur



★ ZK649RNh 180×3,直头,双关节 Straight

颈椎牵开器  
Cervical Retractor



★ ZQ1250RNh 160

颈椎牵开器  
Cervical Retractor

★ ZV521RNh 120×115, 三关节, 齿条式  
Double hinges

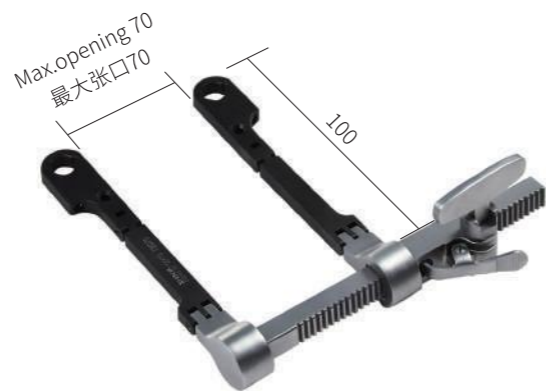

颈椎牵开器  
Cervical Retractor

★ ZV522RNh 200, 三关节, 钳体  
Double hinges



拉钩  
Blade



Depth Width  
高度 宽度

ZV503RNh 35×20, 带齿  
★ ZV515RNh 40×20, 带齿  
ZV506RNh 45×20, 带齿  
★ ZV519RNh 50×20, 带齿  
ZV509RNh 55×20, 带齿  
★ ZV526RNh 60×20, 带齿  
★ ZV512RNh 70×20, 带齿



Depth Width  
高度 宽度

★ ZV518RNh 40×16  
★ ZV525RNh 50×16  
★ ZV532RNh 60×16

Depth Width  
高度 宽度

ZV504RNh 35×20  
★ ZV516RNh 40×20  
ZV507RNh 45×20  
★ ZV524RNh 50×20  
ZV510RNh 55×20  
★ ZV528RNh 60×20  
★ ZV513RNh 70×20



组合示意图  
Combination diagram

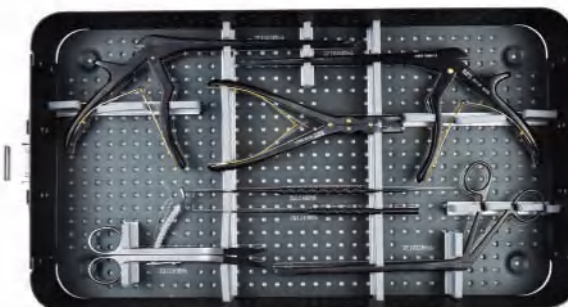
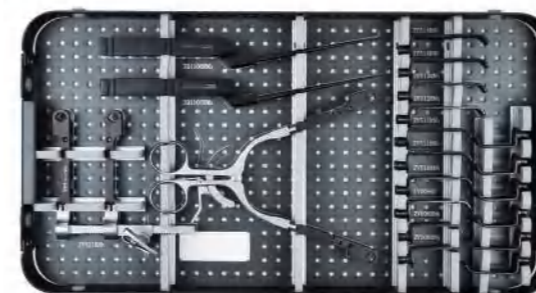

JZQX- I 颈椎前路显微手术器械 (ZQ1290)  
Micro anterior cervical instruments set(ZQ1290)

序号	产品编码	产品名称	规格型号	数量	单位
1	ZQ1106RNh	骨刮匙	250×2×45°,单弯,后,枪状,颈椎型,铝合金柄	1	把
2	ZQ1107RNh	骨刮匙	250×2,直头,枪状,颈椎型,铝合金柄	1	把
3	ZF821RNh	髓核钳	180×2×10,指圈式	1	把
4	ZF485RNsh	椎板咬骨钳	200×2/10×130°,超硬膜,超薄型	1	把
5	ZF661RNdh	椎板咬骨钳	200×1/10×130°,超硬膜,超薄型	1	把
6	ZQ1248RNh	神经剥离器	240×5×Φ0.8,带钩,带槽,颈椎型	1	把
7	ZQ1249RNh	神经剥离器	210×6×Φ1.2,90°	1	把
8	ZK649RNh	咬骨钳	180×3,直头,双关节	1	把
9	ZQ1250RNh	颈椎牵开器	160	1	把
10	ZV521RNh	颈椎牵开器	120×115,三关节,齿条式	1	把
11	ZV522RNh	颈椎牵开器	200,三关节,钳体	1	把
12	ZV503RNh	拉钩	35×20,带齿	1	把
13	ZV504RNh	拉钩	35×20	1	把
14	ZV515RNh	拉钩	40×20,带齿	1	把
15	ZV516RNh	拉钩	40×20	1	把
16	ZV518RNh	拉钩	40×16	2	把
17	ZV506RNh	拉钩	45×20,带齿	1	把
18	ZV507RNh	拉钩	45×20	1	把
19	ZV519RNh	拉钩	50×20,带齿	1	把
20	ZV524RNh	拉钩	50×20	1	把
21	ZV525RNh	拉钩	50×16	2	把
22	ZV509RNh	拉钩	55×20,带齿	1	把
23	ZV510RNh	拉钩	55×20	1	把
24	ZV526RNh	拉钩	60×20,带齿	1	把
25	ZV528RNh	拉钩	60×20	1	把
26	ZV532RNh	拉钩	60×16	2	把
27	ZV512RNh	拉钩	70×20,带齿	1	把
28	ZV513RNh	拉钩	70×20	1	把



显微脊柱手术器械 (ZF1170)  
Micro Spine Surgical Instruments Set (ZF1170)

序号	产品编码	产品名称	规格型号	数量	单位
1	ZF4080RNh	椎板咬骨钳	230×1×130°, 偏体上弯	1	把
2	ZF4081RNh	椎板咬骨钳	230×2×130°, 偏体上弯	1	把
3	ZF4082RNh	椎板咬骨钳	230×3×130°, 偏体上弯	1	把
4	ZF4083RNh	椎板咬骨钳	230×2×130°, 偏体右弯	1	把
5	ZF4084RNh	椎板咬骨钳	230×2×130°, 偏体左弯	1	把
6	ZF4085RNh	髓核钳	150×2, 弯	1	把
7	ZF4086RNh	髓核钳	150×2, 直型	1	把
8	ZF4087RNh	髓核钳	180×1.6, 直型	1	把
9	ZF4088RNh	髓核钳	180×1.6, 弯	1	把
10	ZF4089RNh	吸引管	200×Φ2, 弯	1	支
11	ZF4090RNh	吸引管	200×Φ3, 弯	1	支
12	ZF4091RNh	吸引管	200×Φ3, 弯, 带剥离	1	支
13	ZF4092RNh	显微钩	270×Φ1.2×5, 枪型	1	把
14	ZF4093RNh	显微钩	270×Φ1.2×5, 枪型, 带槽	1	把
15	ZF4094RNh	显微钩	270×Φ2×6, 球头	1	把
16	ZF4095RNh	显微钩	260×5×1.4, 剥离	1	把
17	ZF4096RNh	骨刮匙	160×2, 直形, 枪型	1	把
18	ZF4097RNh	骨刮匙	160×2, 上弯, 枪型	1	把
19	ZF4098RNh	骨刮匙	160×2, 上弯, 反口, 枪型	1	把
20	ZB090RNh	手术刀柄	270, 枪形, 7#, 反向	1	把

直角柄肌腱拉钩  
Retractor  
钩宽×钩深  
★ ZT101R 130x4.5x5.5  
★ ZT102R 130x5x8  
★ ZT103R 130x7x7  
★ ZT104R 150x5x12.5  
ZT105R 180x5x12.5



神经根拉钩 (胶木柄)  
Nerve Root Retractor  
钩宽  
ZQ940R 140x138x3x90°  
ZQ941R 140x138x5x90°  
ZQ942R 140x138x7x90°

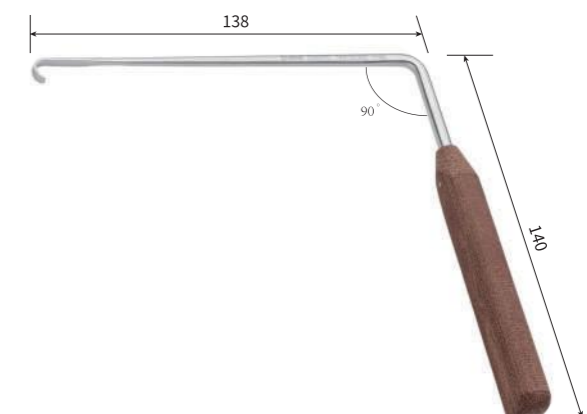

神经根拉钩 (胶木柄)  
Nerve Root Retractor  
钩宽  
★ ZQ977R 150x130x3x90°, 直角钩, 胶木柄  
★ ZQ978R 150x130x5x90°, 直角钩, 胶木柄  
★ ZQ979R 150x130x7x90°, 直角钩, 胶木柄

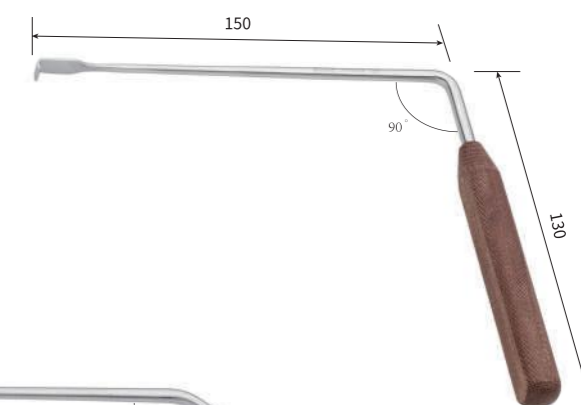

神经根拉钩 (胶木柄)  
Nerve Root Retractor  
ZQ937R 230x3x135°  
ZQ938R 230x5x135°  
ZQ939R 230x7x135°

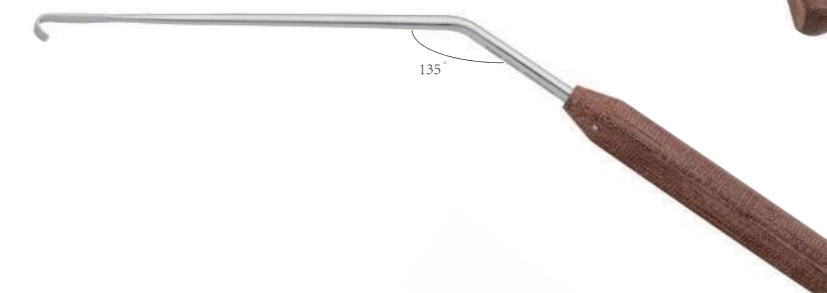

神经根拉钩 (胶木柄)  
Nerve Root Retractor  
★ ZQ974R 230x3x135°, 直角钩, 胶木柄  
★ ZQ975R 230x5x135°, 直角钩, 胶木柄  
★ ZQ976R 230x7x135°, 直角钩, 胶木柄

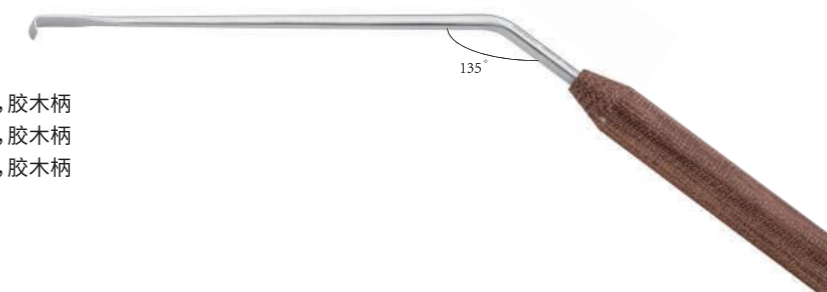

神经根拉钩 (胶木柄)  
Nerve Root Retractor

- ZQ943R 266x3,直
- ZQ944R 266x5,直
- ZQ945R 266x7,直



神经根拉钩 (胶木柄)  
Nerve Root Retractor

- ZQ980R 273x3,直角钩,胶木柄
- ★ ZQ981R 273x5,直角钩,胶木柄
- ZQ982R 273x7,直角钩,胶木柄



神经根拉钩 (板式)  
Nerve Root Retractor

- ZQ2054R 270x3,直
- ★ ZQ2055R 270x5,直
- ZQ2056R 270x7,直



神经根拉钩 (板式)  
Nerve Root Retractor

- ★ ZQ2057R 125x140x3x90°
- ★ ZQ2058R 125x140x5x90°
- ★ ZQ2059R 125x140x7x90°



神经根拉钩 (板式)  
Nerve Root Retractor

- ZQ2060R 230x3x135°
- ★ ZQ2061R 230x5x135°
- ZQ2062R 230x7x135°



神经拉钩  
Nerve Retractor

- ZQ120R 160x4



神经拉钩  
Nerve Retractor

- ★ ZK411R 230x10x7.5
- ★ ZK412R 230x11x8



椎弓根探子  
Vertebral Arch Probe

- ★ ZQ2032R 230xΦ2,带刻度 Graduated
- ★ ZQ2033R 230xΦ2.5,带刻度 Graduated



椎弓根探子  
Vertebral Arch Probe

- ★ ZQ2034R 230xΦ2,弹性 Elastic
- ZQ2035R 230xΦ2.5,弹性 Elastic



神经根探子  
Nerve Root Probe

- ★ ZQ930R 210xΦ3



植骨推棒  
Bone graft impactor

★ ZQ1273R 245×φ8



弯型漏斗  
Curved funnel

★ ZQ1271R 270×φ8



植骨推棒  
Bone graft impactor

★ ZQ1272R 245×φ6



弯型漏斗  
Curved funnel

★ ZQ1270R 240×φ6



短十字锥  
Short Cross Awl

ZQ1276R 215×φ5



长十字锥  
Long Cross Awl

ZQ1275R 220×φ4



限位锥  
Limit Awl

ZQ1274R 220×φ3.5



JZZ- I 型脊柱植骨专用手术器械 (ZF172)  
JZZ-I Bone grafting surgical instruments set for spine

序号	编码	名称	规格	单位	数量
1	ZQ1270R	弯型漏斗	240×φ6	把	1
2	ZQ1271R	弯型漏斗	270×φ8	把	1
3	ZQ1272R	植骨推棒	245×φ6	把	1
4	ZQ1273R	植骨推棒	245×φ8	把	1
5	ZQ1274R	限位锥	220×φ3.5	把	1
6	ZQ1275R	长十字锥	220×φ4	把	1
7	ZQ1276R	短十字锥	215×φ5	把	1

颈椎拉钩  
Cervical Vertebra Retractor

- ★ZT532R 180x25x50
- ★ZT533R 200x25x56



颈椎拉钩  
Cervical Vertebra Retractor

- ★ZT534RN 182x25x40
- ★ZT535RN 182x25x45
- ★ZT536RN 182x25x50



颈椎 S 型拉钩  
Cervical Vertebra Retractor

- ★ZT596RN 220x26x74



椎板拉钩  
Retractor

- ★ZQ868R 150x25x100
- ★ZQ869R 175x28x100
- ★ZQ965R 175x28x80
- ★ZQ966R 175x25x60
- ★ZQ1430R 210x30x100



椎板拉钩  
Retractor

- ★ZQ967R 200x25x60, 尾部上翘型
- ★ZQ968R 200x25x70, 尾部上翘型
- ★ZQ969R 200x25x80, 尾部上翘型



椎板拉钩  
Retractor

- ★ZQ962R 160x23x60
- ★ZQ963R 160x32x80
- ★ZQ964R 160x32x100



脊柱板拉钩  
Spine Retractor

- ZF814R 170x30x65
- ZF813R 170x25x55



硬膜囊拉钩  
Retractor

- ZT540R 250x6
- ★ZT541R 250x8
- ★ZT542R 250x10
- ZT543R 250x12



开口锥  
Opening Awl

- ZQ1297R 颈椎型 cervical vertebra
- ZQ1298R 腰椎型 lumbar vertebra



开口锥  
Opening Awl  
★ ZQ1397RN  
240×2



开口锥  
Opening Awl  
ZQ1398RN  
240×3



开口锥  
Opening Awl  
★ ZQ1399RN  
270×2.5



椎弓根开孔器  
Vertebral Pedicle Awl  
★ ZQ1299R 230×Φ5



可调椎弓根开孔器  
Vertebral Pedicle Awl, adjustable  
ZQ1284R 260×Φ3.5



椎弓根匙形开孔器 (胶木柄)  
Vertebral Pedicle Awl, spoon shaped



ZQ1268R 200×3, 胸椎 For thoracic vertebra

椎弓根匙形开孔器 (胶木柄)  
Vertebral Pedicle Awl, spoon shaped



ZQ1269R 215×3, 腰椎 For thoracic vertebra

手钻  
Hand Drill  
ZQ640R 160×Φ1.6



夹持器  
Positioning nail set  
ZQ1243RB  
315 (带8针)  
(with 8 nails)



椎间盘铰刀手柄  
Reamer handle  
ZQ1983R 椎间盘铰刀手柄



一体型椎间盘铰刀  
Reamer



- |                    |                     |                    |                     |
|--------------------|---------------------|--------------------|---------------------|
| ZQ1950R 300×4,平型有刃 | ZQ1955R 300×9,平型有刃  | ZQ1960R 300×4,平型无刃 | ZQ1965R 300×9,平型无刃  |
| ZQ1951R 300×5,平型有刃 | ZQ1956R 300×10,平型有刃 | ZQ1961R 300×5,平型无刃 | ZQ1966R 300×10,平型无刃 |
| ZQ1952R 300×6,平型有刃 | ZQ1957R 300×11,平型有刃 | ZQ1962R 300×6,平型无刃 | ZQ1967R 300×11,平型无刃 |
| ZQ1953R 300×7,平型有刃 | ZQ1958R 300×12,平型有刃 | ZQ1963R 300×7,平型无刃 | ZQ1968R 300×12,平型无刃 |
| ZQ1954R 300×8,平型有刃 | ZQ1959R 300×13,平型有刃 | ZQ1964R 300×8,平型无刃 | ZQ1969R 300×13,平型无刃 |



- |                        |                         |                   |
|------------------------|-------------------------|-------------------|
| ZQ1970R 300×4,平型有刃,带圆角 | ZQ1975R 300×9,平型有刃,带圆角  | ZQ1980R 300×9,圆型  |
| ZQ1971R 300×5,平型有刃,带圆角 | ZQ1976R 300×10,平型有刃,带圆角 | ZQ1981R 300×11,圆型 |
| ZQ1972R 300×6,平型有刃,带圆角 | ZQ1977R 300×11,平型有刃,带圆角 | ZQ1982R 300×13,圆型 |
| ZQ1973R 300×7,平型有刃,带圆角 | ZQ1978R 300×12,平型有刃,带圆角 |                   |
| ZQ1974R 300×8,平型有刃,带圆角 | ZQ1979R 300×13,平型有刃,带圆角 |                   |

分体型椎间盘铰刀  
Reamer



- |                    |                     |                    |                     |
|--------------------|---------------------|--------------------|---------------------|
| ZQ1984R 220×4,平型有刃 | ZQ1989R 220×9,平型有刃  | ZQ1994R 220×4,平型无刃 | ZQ1999R 220×9,平型无刃  |
| ZQ1985R 220×5,平型有刃 | ZQ1990R 220×10,平型有刃 | ZQ1995R 220×5,平型无刃 | ZQ2000R 220×10,平型无刃 |
| ZQ1986R 220×6,平型有刃 | ZQ1991R 220×11,平型有刃 | ZQ1996R 220×6,平型无刃 | ZQ2001R 220×11,平型无刃 |
| ZQ1987R 220×7,平型有刃 | ZQ1992R 220×12,平型有刃 | ZQ1997R 220×7,平型无刃 | ZQ2002R 220×12,平型无刃 |
| ZQ1988R 220×8,平型有刃 | ZQ1993R 220×13,平型有刃 | ZQ1998R 220×8,平型无刃 | ZQ2003R 220×13,平型无刃 |



- |                        |                         |                   |
|------------------------|-------------------------|-------------------|
| ZQ2004R 220×4,平型有刃,带圆角 | ZQ2009R 220×9,平型有刃,带圆角  | ZQ2014R 220×9,圆型  |
| ZQ2005R 220×5,平型有刃,带圆角 | ZQ2010R 220×10,平型有刃,带圆角 | ZQ2015R 220×11,圆型 |
| ZQ2006R 220×6,平型有刃,带圆角 | ZQ2011R 220×11,平型有刃,带圆角 | ZQ2016R 220×13,圆型 |
| ZQ2007R 220×7,平型有刃,带圆角 | ZQ2012R 220×12,平型有刃,带圆角 |                   |
| ZQ2008R 220×8,平型有刃,带圆角 | ZQ2013R 220×13,平型有刃,带圆角 |                   |

椎管骨打击器  
Bone grafting impactor



- |                       |                        |
|-----------------------|------------------------|
| ★ ZQ2041R 260x3.5x90° | ★ ZQ2044R 260x3.5x110° |
| ★ ZQ2042R 260x5x90°   | ZQ2045R 260x5x110°     |
| ZQ2043R 260x6.5x90°   | ★ ZQ2046R 260x6.5x110° |

棘突打孔器  
Punch For Spinous Process

- ★ ZK426R 小号 small
- ★ ZK427R 大号 large



棘突打孔器  
Punch For Spinous Process

- ★ ZK413R 220x25



椎板牵开器  
Self-retaining Retractor

- ★ ZV303R 210×40×φ4
- ★ ZV304R 210×60×φ4



椎板牵开器

ZV299R 150, 锐钩, 直角弯  
Sharp



椎板牵开器

Self-retaining Retractor

★ ZV280R 170x40x12, 单钩, 直角弯  
★ ZV281R 170x60x12, 单钩, 直角弯



椎板牵开器

Self-retaining Retractor

★ ZV295R 210x40xΦ6, 单钩, 直角弯  
★ ZV296R 210x60xΦ6, 单钩, 直角弯  
★ ZV297R 210x85xΦ6, 单钩, 直角弯



椎板牵开器

Self-retaining Retractor

★ ZV291RN 180x40xΦ3, 单钩  
★ ZV292RN 180x50xΦ3, 单钩  
★ ZV293RN 180x60xΦ3, 单钩  
★ ZV294RN 180x70xΦ3, 单钩

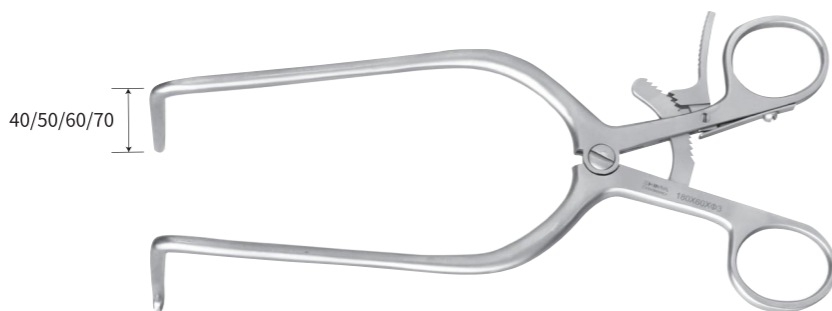

单侧椎板牵开器

Self-retaining Retractor

left blade, right hook  
ZV283RN 180x50x20, 左板右钩  
★ ZV284RN 180x60x20, 左板右钩  
ZV285RN 180x70x20, 左板右钩

right blade, left hook  
ZV286RN 180x50x20, 左钩右板  
ZV287RN 180x60x20, 左钩右板  
ZV288RN 180x70x20, 左钩右板



单侧椎板牵开器

Self-retaining Retractor

left blade right blade  
★ ZV289RN 180, 左板55x25, 右板65x35



单侧椎板牵开器

Self-retaining Retractor

right blade left blade  
ZV290RN 180, 右板55x25, 左板65x35



后颅凹牵开器

Self-retaining Retractor

★ ZV265RN 200x60x8, 单钩, 头弯60°  
Tip curved 60°



后颅凹牵开器  
Opening Self-retaining Retractor

- ★ ZV266RN 200x18, 固定式4x4钩, 头弯45°  
Tip curved 45°
- ZV267RN 200x30, 固定式4x4钩, 头弯45°  
Tip curved 45°



后颅凹牵开器  
Self-retaining Retractor

- ★ ZV269RN 220x30, 固定式4x4钩, 头弯45°  
Tip curved 45°



后颅凹牵开器  
Self-retaining Retractor

- ZV271RN 280x60, 活动式5x6钩 (活节带齿)



后颅凹牵开器  
Self-retaining Retractor, blunt

- ★ ZV272R 280x30, 活动式4x4钝钩, 直型
- ★ ZV277R 290x23, 活动式4x4钝钩, 直型



椎板牵开器  
Self-retaining Retractor

- ★ ZV274R 300x45, 活动式5x5钝钩, 直型



颈部牵开器  
Retractor, Cervical, Complete Set

- ★ ZV380R 185



颈部牵开器  
Retractor, Cervical, Complete Set

- ★ ZV400R 280

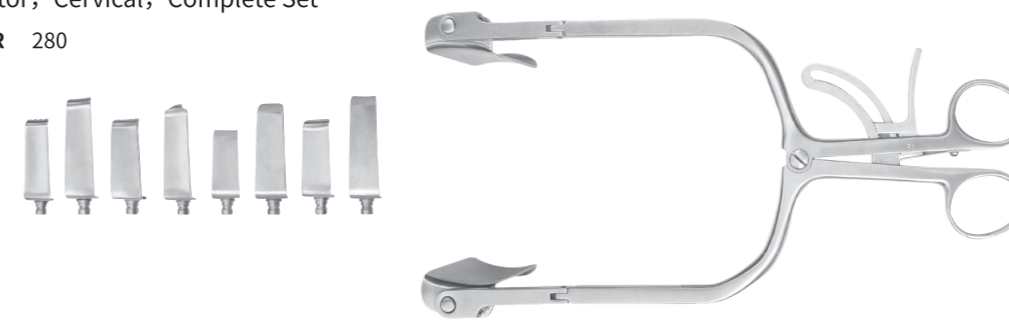

颈椎牵开器  
Retractor, Cervical,  
Complete Set

- ★ ZV407RN 140x120, 齿条式 (配14对拉钩)  
(with 14 pairs of blades)

有齿拉钩 Toothed hook	35x20mm 40x20mm 45x20mm	50x20mm 55x20mm 60x20mm	65x20mm	无齿拉钩 Blunt hook	35x20mm 40x20mm 45x20mm	50x20mm 55x20mm 60x20mm	65x20mm
----------------------	-------------------------------	-------------------------------	---------	--------------------	-------------------------------	-------------------------------	---------

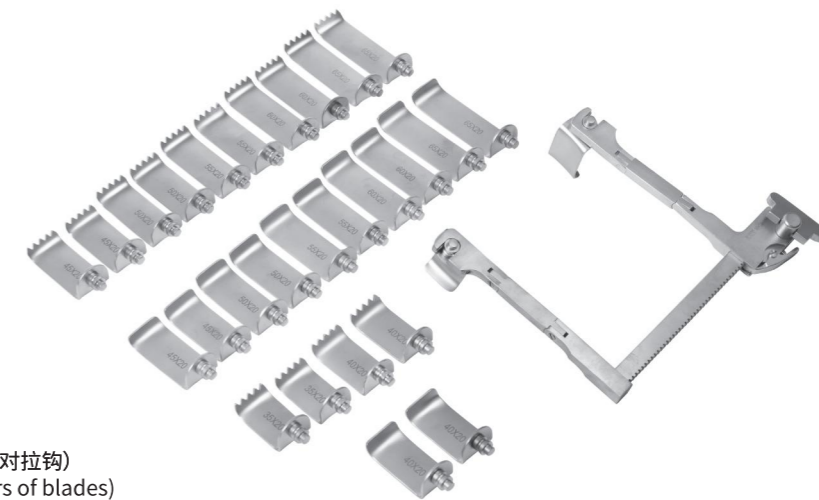

颈椎牵开器  
Re tractor, cervical

ZV409R/RN 185, 双关节, 钳体



颈椎牵开器  
Re tractor, cervical

ZV410R/RN 235, 三关节, 钳体



牵开拉钩  
Blade

ZV411R/RN 30X16  
ZV412R/RN 40X16  
ZV413R/RN 50X16  
ZV414R/RN 60X16

配合ZV409R/RN ZV410R/RN使用  
For zv409R/RN Z V410R/RN



颈椎牵开器  
Re tractor, cervical, complete set

★ZV405RN (左向) 包含牵开器1个, 牵开螺钉6个及上钉器1个  
(left) Including 1 retractor, 6 screws and 1 screw applier

ZV406RN (右向)  
(right)



颈椎后缘牵开器  
cervical Re tractor

★ZQ960RN 180X6



颈椎牵开器  
CErvical Retractor

ZQ1250RNh 160



颈椎牵开器  
cervical Retractor

ZV521RNh 120X 115, 三关节, 齿条式

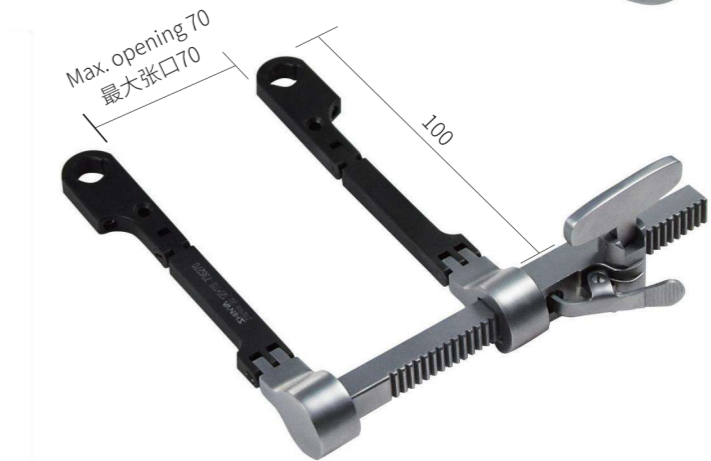

颈椎牵开器  
cervical Retractor

ZV522RNh 200, 三关节, 钳体



拉钩  
Blade for ZV521RNh and ZV522RNh

	高度 H	宽度 W
ZV503RNh	35	20, 带齿
ZV515RNh	40	20, 带齿
ZV506RNh	45	20, 带齿
ZV519RNh	50	20, 带齿
ZV509RNh	55	20, 带齿
ZV526RNh	60	20, 带齿
ZV512RN	70	20, 带齿



拉钩  
Blade for ZV521RNh and ZV522RNh

	高度 H	宽度 W
ZV505RNh	35	16
ZV518RNh	40	16
ZV508RNh	45	16
ZV525RNh	50	16
ZV511RNh	55	16
ZV532RNh	60	16
ZV514RNh	70	16



ZV504RNh	35	20
ZV516RNh	40	20
ZV507RNh	45	20
ZV524RNh	50	20
ZV510RNh	55	20
ZV528RNh	60	20
ZV513RNh	70	20

腰椎牵开器  
Lumbar Retractor

- ★ ZV720R
- 齿条x臂长 200x155
- 拉钩 54x44
- 65x44
- 73x44
- 83x44
- 2把/种 共8把
- 2pcs/pair, 8 pcs



脊柱深部牵开器  
Spinal Deep Retractor

- ZV713R 50x65, 240x160, 叶6x7齿
- ★ ZV714RN 50x75, 240x160, 叶6x7齿
- ★ ZV715RN 50x85, 240x160, 叶6x7齿
- ZV716R 40x65, 240x160, 叶3x4齿



脊柱撑开器  
Spinal Spreader

- ★ ZQ1266R 260x65



椎板撑开钳  
Lumbar Distractor

- ★ ZQ959R 230



椎体平行撑开器  
Vertebral Spreader

- ZQ1263R 350



压缩钳  
Compressing Forceps

- ZQ1541R III型



颈椎牵开器

Re tractor, cervical, complete set

ZV403RN (左向) 包含牵开器1个, 牵开螺钉6个及上钉器1个  
(left) including 1 retractor, 6 screws and 1 screw applier

ZV404RN (右向) 包含牵开器1个, 牵开螺钉6个及上钉器1个  
(right) including 1 retractor, 6 screws and 1 screw applier



拉钩  
Retractor



- ZQ3801RN 255×10
- ZQ3802RN 255×8
- ZQ3803RN 255×6

骨刀  
Gouge



- ★ ZQ3804RN 310×7.5
- ZQ3805RN 310×12.5
- ★ ZQ3806RN 310×8.5
- ★ ZQ3807RN 310×10

骨锤  
Bone Mallet



- ZQ3808RN 180/550g

扩孔器  
Reamer



- ZQ3809RN 310×7, 直
- ZQ3810RN 310×9, 直
- ZQ3811RN 310×8.5, 尖圆头
- ZQ3812RN 310×16, 尖圆头

骨刮匙  
Bone Curette



- ZQ3813RN 310×5, 正口
- ZQ3814RN 310×5, 反口  
Reverse opening
- ★ ZQ3815RN 310×7, 带齿, 左弯  
Left curved
- ★ ZQ3816RN 310×7, 带齿, 右弯  
Right curved

骨刀  
Gouge



- ZQ3817RN 310×20
- ZQ3818RN 310×25
- ZQ3819RN 310×15

骨凿  
Osteotome



- ZQ3820RN 320
- ZQ3821RN 335

骨拉钩  
Retractor



- ★ ZT907RN 95×15
- ★ ZT908RN 95×20
- ★ ZT909RN 95×25

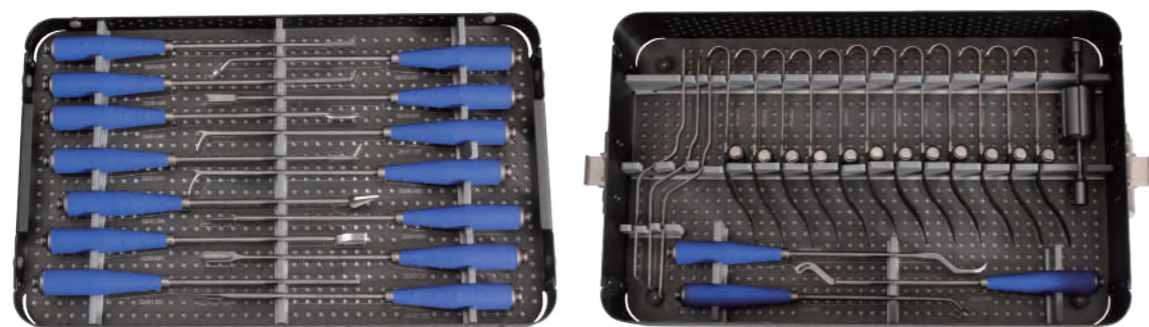

JG-III 脊柱截骨手术器械(ZQ3800)

JG-III Pedicle subtraction osteotomy(PSO) surgical instruments set( ZQ3800)

序号	产品编码	产品名称	规格型号	数量	单位
1	ZQ3801RN	拉钩	255×10	1	把
2	ZQ3802RN	拉钩	255×8	1	把
3	ZQ3803RN	拉钩	255×6	1	把
4	ZQ3804RN	骨刀	310×7.5	1	把
5	ZQ3805RN	骨刀	310×12.5	1	把
6	ZQ3806RN	骨刀	310×8.5	1	把
7	ZQ3807RN	骨刀	310×10	1	把
8	ZQ3808RN	骨锤	180/550g	1	把
9	ZQ3809RN	扩孔器	310×7,直	1	把
10	ZQ3810RN	扩孔器	310×9,直	1	把
11	ZQ3811RN	扩孔器	310×8.5,尖圆头	1	把
12	ZQ3812RN	扩孔器	310×16,尖圆头	1	把
13	ZQ3813RN	骨刮匙	310×5,正口	1	把
14	ZQ3814RN	骨刮匙	310×5,反口	1	把
15	ZQ3815RN	骨刮匙	310×7,带齿,左弯	1	把
16	ZQ3816RN	骨刮匙	310×7,带齿,右弯	1	把
17	ZQ3817RN	骨刀	310×20	1	把
18	ZQ3818RN	骨刀	310×25	1	把
19	ZQ3819RN	骨刀	310×15	1	把
20	ZQ3820RN	骨凿	320	1	把
21	ZQ3821RN	骨凿	335	1	把
22	ZT907RN	骨拉钩	95×15	4	把
23	ZT908RN	骨拉钩	95×20	4	把
24	ZT909RN	骨拉钩	95×25	4	把



JZQ- I 型颈椎前路专用手术器械(ZF108)

JZQ-I Anterior cervical surgery surgical instruments set

序号	编码	名称	规格	单位	数量
1	ZV405RN	颈椎牵开器	包含牵开器、牵开螺钉	套	1
2	ZF1026RNdh	椎板咬骨钳	230×1×90°,普通型,超硬膜	把	1
3	ZF687RNsh	椎板咬骨钳	230×2×110°,普通型,超硬膜	把	1
4	ZF693RNsh	椎板咬骨钳	230×2×130°,普通型,超硬膜	把	1
5	ZF1035RNdh	椎板咬骨钳	230×1×110°,超薄型,超硬膜	把	1
6	ZF488RNsh	椎板咬骨钳	230×2×130°,超薄型,超硬膜	把	1
7	ZF479RNsh	椎板咬骨钳	230×2×110°,超薄型,超硬膜	把	1
8	ZF890RNj	髓核钳(指圈式)	220×2	把	1
9	ZF982RNj	髓核钳(指圈式)	220×2×150°	把	1
10	ZF834RNj	髓核钳(指圈式)	220×3	把	1
11	ZF983RNj	髓核钳(指圈式)	220×3×150°	把	1
12	ZK589RNh	双关节咬骨钳	240×2×20°,弯头	把	1
13	ZK593RNh	双关节咬骨钳	240×2×38°,弯头	把	1
14	ZQ1025RN	骨刮匙(铝合金柄)	300×3×5°,前弯	把	1
15	ZQ1026RN	骨刮匙(铝合金柄)	300×3×10°,前弯	把	1
16	ZQ1033RN	骨刮匙(铝合金柄)	300×4×5°,前弯	把	1
17	ZT596RN	颈椎S型拉钩	220×26×74	把	2
18	ZT533RN	颈椎拉钩	200×25×56,大号	把	1
19	ZT532RN	颈椎拉钩	180×25×50,小号	把	1
20	ZQ1258RN	带钩带槽神经剥离子	240×5×Φ0.8	把	2
21	ZQ775RN	薄型骨刀	200×3	把	1
22	ZQ776RN	薄型骨刀	200×4	把	1
23	ZQ777RN	薄型骨刀	200×5	把	1
24	ZQ779RN	薄型骨刀	200×8	把	1
25	ZQ924RN	锤骨器	210×Φ8	把	1

序号	编码	名称	规格	单位	数量
26	ZF1000RN	吸引管	260×Φ2	支	1
27	ZF921RN	吸引管	260×Φ3	支	1
28	ZF1005RN	吸引管	260×Φ4	支	1

JZQ- II 型颈椎前路专用手术器械 (ZF175)  
JZQ- II Anterior cervical surgery surgical instruments set

序号	编码	名称	规格	单位	数量
1	ZV405RN	颈椎牵开器	包含牵开器、牵开螺钉	套	1
2	ZF1026Rd	椎板咬骨钳	230×1×90°, 普通型	把	1
3	ZF687Rs	椎板咬骨钳	230×2×110°, 普通型	把	1
4	ZF693Rs	椎板咬骨钳	230×2×130°, 普通型	把	1
5	ZF1035Rd	椎板咬骨钳	230×1×110°, 超薄型	把	1
6	ZF488Rs	椎板咬骨钳	230×2×130°, 超薄型	把	1
7	ZF479Rs	椎板咬骨钳	230×2×110°, 超薄型	把	1
8	ZF890RNj	髓核钳(指圈式)	220×2	把	1
9	ZF982RNj	髓核钳(指圈式)	220×2×150°	把	1
10	ZF834RNj	髓核钳(指圈式)	220×3	把	1
11	ZF983RNj	髓核钳(指圈式)	220×3×150°	把	1
12	ZK589RNh	双关节咬骨钳	240×2×20°, 弯头	把	1
13	ZK593RNh	双关节咬骨钳	240×2×38°, 弯头	把	1
14	ZQ1025RN	骨刮匙(铝合金柄)	300×3×5°, 前弯	把	1
15	ZQ1026RN	骨刮匙(铝合金柄)	300×3×10°, 前弯	把	1
16	ZQ1033RN	骨刮匙(铝合金柄)	300×4×5°, 前弯	把	1
17	ZT596RN	颈椎S型拉钩	220×26×74	把	2
18	ZT533RN	颈椎拉钩	200×25×56, 大号	把	1
19	ZT532RN	颈椎拉钩	180×25×50, 小号	把	1
20	ZQ1258RN	带钩带槽神经剥离器	240×5×Φ0.8	把	2
21	ZQ775RN	薄型骨刀	200×3	把	1
22	ZQ776RN	薄型骨刀	200×4	把	1
23	ZQ777RN	薄型骨刀	200×5	把	1
24	ZQ779RN	薄型骨刀	200×8	把	1
25	ZQ924RN	锤骨器	210×Φ8	把	1
26	ZF1000RN	吸引管	260×Φ2	支	1
27	ZF921RN	吸引管	260×Φ3	支	1
28	ZF1005RN	吸引管	260×Φ4	支	1

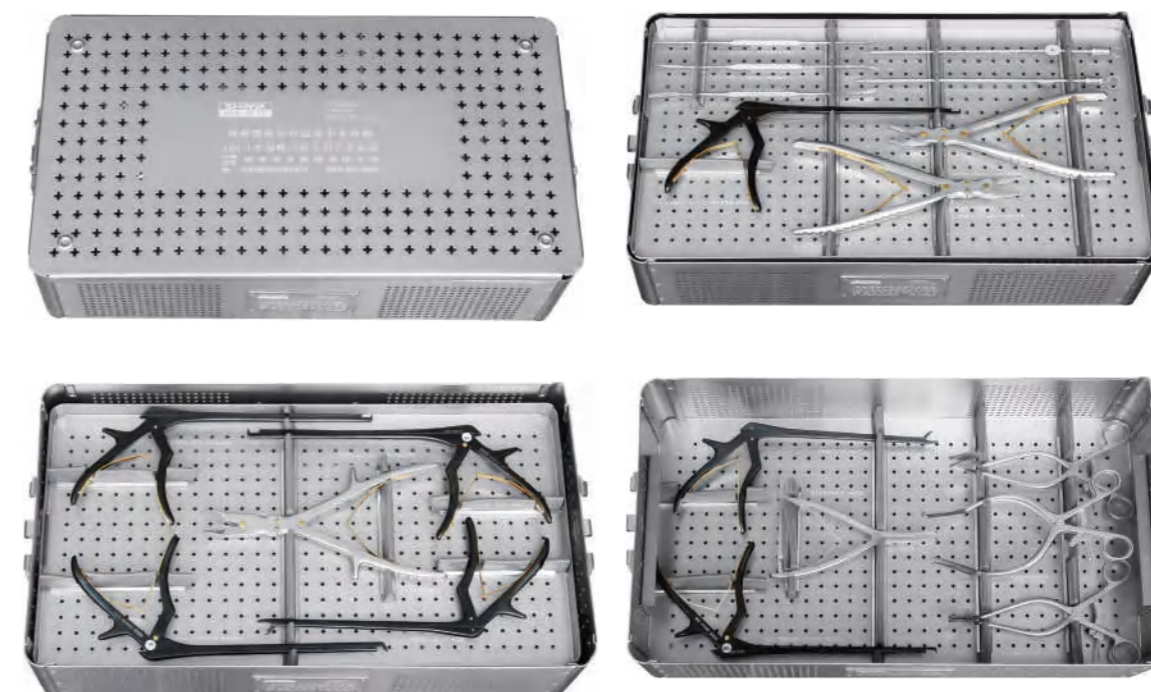

JZH- I 型颈椎后路专用手术器械 (ZF109)  
JZH-I posterior cervical surgical instruments set

序号	编码	名称	规格	单位	数量
1	ZF687RNsh	椎板咬骨钳	230×2×110°, 普通型, 超硬膜	把	1
2	ZF694RNsh	椎板咬骨钳	230×3×130°, 普通型, 超硬膜	把	1
3	ZF488RNsh	椎板咬骨钳	230×2×130°, 超薄型, 超硬膜	把	1
4	ZF480RNsh	椎板咬骨钳	230×3×110°, 超薄型, 超硬膜	把	1
5	ZF1035RNdh	椎板咬骨钳	230×1×110°, 超薄型, 超硬膜	把	1
6	ZK641RNh	双关节咬骨钳	240×3×20°, 弯尖头	把	1
7	ZK589RNh	双关节咬骨钳	240×2×20°, 弯头	把	1
8	ZF570RNdh	髓核钳(握柄式)	220×2×6, 超硬膜	把	1
9	ZF574RNdh	髓核钳(握柄式)	220×3×8, 超硬膜	把	1
10	ZK620RNj	双关节咬骨剪	240×30°, 弯	把	1
11	ZV266RN	后颅凹牵开器	200×18, 固定式4×4钩, 头弯45°	把	1
12	ZV267RN	后颅凹牵开器	200×30, 固定式4×4钩, 头弯45°	把	1
13	ZV265RN	后颅凹牵开器	200×60×8, 单钩, 头弯60°	把	2
14	ZQ960RN	颈椎后缘牵开器	180	把	1
15	ZQ755RN	神经剥离器	240×3	把	1
16	ZQ756RN	神经剥离器	240×5	把	1
17	ZQ1258RN	带钩带槽神经剥离器	240×5×Φ0.8	把	1
18	ZF921RN	吸引管	260×Φ3	把	1
19	ZF1005RN	吸引管	260×Φ4	把	1

JZH- II 型颈椎后路专用手术器械 (ZF176)  
JZH-II posterior cervical surgical instruments set

序号	编码	名称	规格	单位	数量
1	ZF687Rs	椎板咬骨钳	230×2×110°,普通型	把	1
2	ZF694Rs	椎板咬骨钳	230×3×130°,普通型	把	1
3	ZF488Rs	椎板咬骨钳	230×2×130°,超薄型	把	1
4	ZF480Rs	椎板咬骨钳	230×3×110°,超薄型	把	1
5	ZF1035Rd	椎板咬骨钳	230×1×110°,超薄型	把	1
6	ZK641RNh	双关节咬骨钳	240×3×20°,弯尖头	把	1
7	ZK589RNh	双关节咬骨钳	240×2×20°,弯头	把	1
8	ZF570Rd	髓核钳(握柄式)	220×2×6	把	1
9	ZF574Rd	髓核钳(握柄式)	220×3×8	把	1
10	ZK620RNj	双关节咬骨剪	240×30°,弯	把	1
11	ZV266RN	后颅凹牵开器	200×18,固定式4×4钩,头弯45°	把	1
12	ZV267RN	后颅凹牵开器	200×30,固定式4×4钩,头弯45°	把	1
13	ZV265RN	后颅凹牵开器	200×60×8,单钩,头弯60°	把	2
14	ZQ960RN	颈椎后缘牵开器	180	把	1
15	ZQ755RN	神经剥离器	240×3	把	1
16	ZQ756RN	神经剥离器	240×5	把	1
17	ZQ1258RN	带钩带槽神经剥离器	240×5×Φ0.8	把	1
18	ZF921RN	吸引管	260×Φ3	把	1
19	ZF1005RN	吸引管	260×Φ4	把	1



ZPQ- I 型椎间盘切除专用手术器械 (ZF171)  
ZPQ-I discectomy surgical instruments set

序号	编码	名称	规格	单位	数量
1	ZF688RNsh	椎板咬骨钳	230×3×110°,普通型,超硬膜	把	1
2	ZF695RNsh	椎板咬骨钳	230×4×130°,普通型,超硬膜	把	1
3	ZF489RNsh	椎板咬骨钳	230×3×130°,超薄型,超硬膜	把	1
4	ZF570RNdh	髓核钳(握柄式)	220×2×6,超硬膜	把	1
5	ZF590RNdh	髓核钳(握柄式)	220×3×8×150°,超硬膜	把	1
6	ZF582RNdh	髓核钳(握柄式)	220×5×12,超硬膜	把	1
7	ZK590RNh	双关节咬骨钳	240×3×20°,弯头	把	1
8	ZK591RNh	双关节咬骨钳	240×4×20°,弯头	把	1
9	ZQ927RN	神经根拉钩	230×3×135°	把	1
10	ZQ928RN	神经根拉钩	230×5×135°	把	1
11	ZQ929RN	神经根拉钩	230×7×135°	把	1
12	ZQ705RN	髓核凿(骨刀)	235×Φ6	把	1
13	ZQ706RN	髓核凿(骨刀)	235×Φ8	把	1
14	ZQ707RN	髓核凿(骨刀)	235×Φ10	把	1
15	ZQ708RN	髓核凿(骨刀)	6.5×5.2,椭圆	把	1
16	ZQ709RN	髓核凿(骨刀)	8.5×7.2,椭圆	把	1
17	ZQ710RN	髓核凿(骨刀)	10.5×9.2,椭圆	把	1
18	ZQ869RN	椎板拉钩	大,175×28×100	把	1
19	ZQ965RN	椎板拉钩	中,175×28×80	把	1
20	ZQ966RN	椎板拉钩	小,175×25×60	把	1
21	ZV271RN	后颅凹牵开器	280×60,活动式5×6钩(活节带齿)	把	2
22	ZQ1033RN	骨刮匙(铝合金柄)	300×4×5°,前弯	把	1
23	ZQ1042RN	骨刮匙(铝合金柄)	300×5×10°,前弯	把	1
24	ZQ1050RN	骨刮匙(铝合金柄)	300×6×10°,前弯	把	1

ZPQ- II 型椎间盘切除专用手术器械 (ZF177)  
ZPQ- II discectomy surgical instruments set

序号	编码	名称	规格	单位	数量
1	ZF688Rs	椎板咬骨钳	230×3×110°,普通型	把	1
2	ZF695Rs	椎板咬骨钳	230×4×130°,普通型	把	1
3	ZF489Rs	椎板咬骨钳	230×3×130°,超薄型	把	1
4	ZF570Rd	髓核钳(握柄式)	220×2×6	把	1
5	ZF590Rd	髓核钳(握柄式)	220×3×8×150°	把	1
6	ZF582Rd	髓核钳(握柄式)	220×5×12	把	1
7	ZK590RNh	双关节咬骨钳	240×3×20°,弯头	把	1
8	ZK591RNh	双关节咬骨钳	240×4×20°,弯头	把	1
9	ZQ927RN	神经根拉钩	230×3×135°	把	1
10	ZQ928RN	神经根拉钩	230×5×135°	把	1
11	ZQ929RN	神经根拉钩	230×7×135°	把	1
12	ZQ705RN	髓核凿(骨刀)	235×Φ6	把	1
13	ZQ706RN	髓核凿(骨刀)	235×Φ8	把	1
14	ZQ707RN	髓核凿(骨刀)	235×Φ10	把	1
15	ZQ708RN	髓核凿(骨刀)	6.5×5.2, 椭圆	把	1
16	ZQ709RN	髓核凿(骨刀)	8.5×7.2, 椭圆	把	1
17	ZQ710RN	髓核凿(骨刀)	10.5×9.2, 椭圆	把	1
18	ZQ869RN	椎板拉钩	大,175×28×100	把	1
19	ZQ965RN	椎板拉钩	中,175×28×80	把	1
20	ZQ966RN	椎板拉钩	小,175×25×60	把	1
21	ZV271RN	后颅凹牵开器	280×60, 活动式5×6钩(活节带齿)	把	2
22	ZQ1033RN	骨刮匙(铝合金柄)	300×4×5°,前弯	把	1
23	ZQ1042RN	骨刮匙(铝合金柄)	300×5×10°,前弯	把	1
24	ZQ1050RN	骨刮匙(铝合金柄)	300×6×10°,前弯	把	1

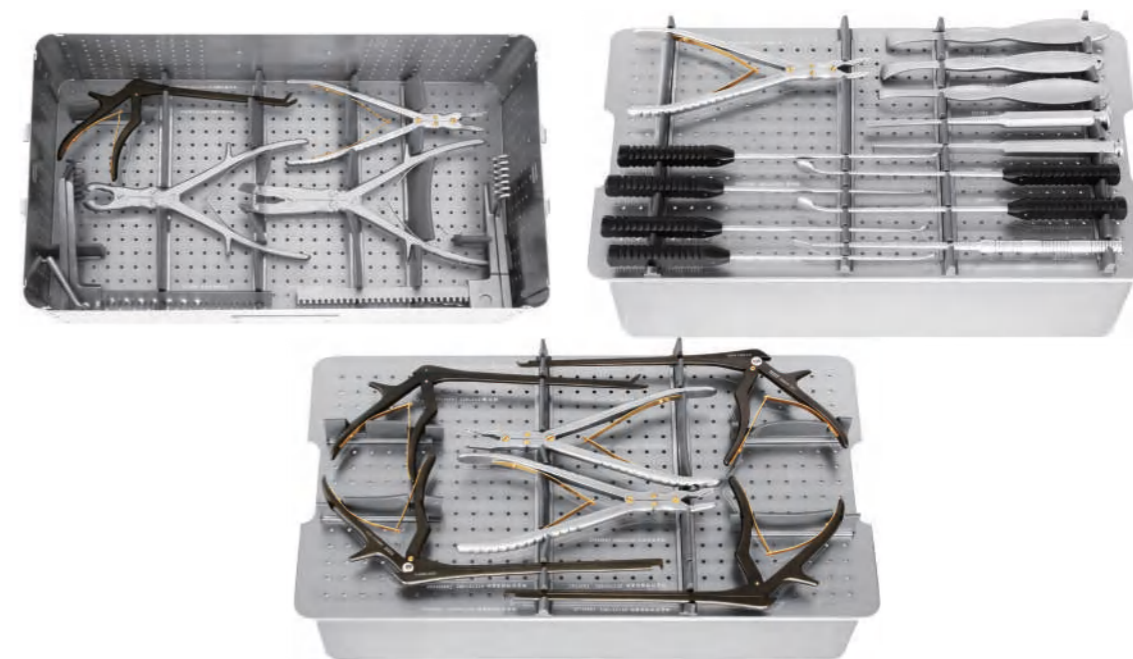

ZZH- I 型脊柱后路专用手术器械 (ZF173)  
ZZH-I posterior spine surgical instruments set

序号	编码	名称	规格	单位	数量
1	ZF688RNsh	椎板咬骨钳	230×3×110°,普通型,超硬膜	把	1
2	ZF1362RNsh	椎板咬骨钳	260×4×130°,普通型,超硬膜	把	1
3	ZF689RNsh	椎板咬骨钳	230×4×110°,普通型,超硬膜	把	1
4	ZF481RNsh	椎板咬骨钳	230×4×110°,超薄型,超硬膜	把	1
5	ZF1361RNsh	椎板咬骨钳	260×4×110°,超薄型,超硬膜	把	1
6	ZF489RNsh	椎板咬骨钳	230×3×130°,超薄型,超硬膜	把	1
7	ZK586RNh	双关节咬骨钳	240×3,直头	把	1
8	ZK590RNh	双关节咬骨钳	240×3×20°,弯头	把	1
9	ZK595RNh	双关节咬骨钳	240×4×38°,弯头	把	1
10	ZK641RNh	双关节咬骨钳	240×3×20°,尖头	把	1
11	ZF570RNdh	髓核钳(握柄式)	220×2×6,超硬膜	把	1
12	ZF574RNdh	髓核钳(握柄式)	220×3×8,超硬膜	把	1
13	ZF665RNdh	髓核钳(握柄式)	260×4×10×150°,超硬膜	把	1
14	ZF666RNdh	髓核钳(握柄式)	260×4×10,弧形,超硬膜	把	1
15	ZQ844RN	骨膜剥离器	220×10	把	1
16	ZQ845RN	骨膜剥离器	220×15	把	1
17	ZQ846RN	骨膜剥离器	220×20	把	1
18	ZQ783RN	骨膜分离器(铝合金柄)	300×Φ20,锐口	把	1
19	ZQ784RN	骨膜分离器(铝合金柄)	300×Φ20,钝口	把	1
20	ZQ1030RN	骨刮匙(铝合金柄)	300×4,直形	把	1
21	ZQ1033RN	骨刮匙(铝合金柄)	300×4×5°,前弯	把	1
22	ZQ1041RN	骨刮匙(铝合金柄)	300×5×5°,前弯	把	1
23	ZQ1042RN	骨刮匙(铝合金柄)	300×5×10°,前弯	把	1
24	ZQ373RN	薄型骨刀(六角柄)	240×8	把	1
25	ZQ375RN	薄型骨刀(六角柄)	240×12	把	1

序号	编码	名称	规格	单位	数量
26	ZQ1216RN	薄型骨刀	300×10	把	1
27	ZK565RN	双关节棘突咬骨剪	290×16	把	1
28	ZK564RN	双关节棘突咬骨钳	260×16	把	1
29	ZV714RN	脊柱深部牵开器	50×75,240×160,叶6×7齿	把	1
30	ZV715RN	脊柱深部牵开器	50×85,240×160,叶6×7齿	把	1

ZZH- II 型脊柱后路专用手术器械 (ZF178)  
ZZH- II posterior spine surgical instruments set

序号	编码	名称	规格	单位	数量
1	ZF688Rs	椎板咬骨钳	230×3×110°,普通型	套	1
2	ZF1362Rs	椎板咬骨钳	260×4×130°,普通型	把	1
3	ZF689Rs	椎板咬骨钳	230×4×110°,普通型	把	1
4	ZF481Rs	椎板咬骨钳	230×4×110°,超薄型	把	1
5	ZF1361Rs	椎板咬骨钳	260×4×110°,超薄型	把	1
6	ZF489Rs	椎板咬骨钳	230×3×130°,超薄型	把	1
7	ZK586RNh	双关节咬骨钳	240×3,直头	把	1
8	ZK590RNh	双关节咬骨钳	240×3×20°,弯头	把	1
9	ZK595RNh	双关节咬骨钳	240×4×38°,弯头	把	1
10	ZK641RNh	双关节咬骨钳	240×3×20°,尖头	把	1
11	ZF570Rd	髓核钳(握柄式)	220×2×6	把	1
12	ZF574Rd	髓核钳(握柄式)	220×3×8	把	1
13	ZF665Rd	髓核钳(握柄式)	260×4×10×150°	把	1
14	ZF666Rd	髓核钳(握柄式)	260×4×10,弧形	把	1
15	ZQ844RN	骨膜剥离器	220×10	把	1
16	ZQ845RN	骨膜剥离器	220×15	把	1
17	ZQ846RN	骨膜剥离器	220×20	把	1
18	ZQ783RN	骨膜分离器(铝合金柄)	300×Φ20,锐口	把	1
19	ZQ784RN	骨膜分离器(铝合金柄)	300×Φ20,钝口	把	1
20	ZQ1030RN	骨刮匙(铝合金柄)	300×4,直形	把	1
21	ZQ1033RN	骨刮匙(铝合金柄)	300×4×5°,前弯	把	1
22	ZQ1041RN	骨刮匙(铝合金柄)	300×5×5°,前弯	把	1
23	ZQ1042RN	骨刮匙(铝合金柄)	300×5×10°,前弯	把	1
24	ZQ373RN	薄型骨刀(六角柄)	240×8	把	1
25	ZQ375RN	薄型骨刀(六角柄)	240×12	把	1
26	ZQ1216RN	薄型骨刀	300×10	把	1
27	ZK565RN	双关节棘突咬骨剪	290×16	把	1
28	ZK564RN	双关节棘突咬骨钳	260×16	把	1
29	ZV714RN	脊柱深部牵开器	50×75,240×160,叶6×7齿	把	1
30	ZV715RN	脊柱深部牵开器	50×85,240×160,叶6×7齿	把	1



DJQ- I 型颈椎牵开手术器械包 (ZV570)  
DJQ-I cervical retractor set

序号	编码	名称	规格	单位	数量
1	ZV410RN	颈椎三关节牵开器钳体	235	套	1
2	ZV407RN	颈椎牵开器	140×120,齿条式(配14对拉钩)	套	1



JQK- I 型颈椎牵开手术器械包 (ZV408)  
JQK-I cervical retractor set

序号	编码	名称	规格	单位	数量
1	ZV409R	双关节牵开器钳体	全长185	把	1
2	ZV410R	三关节牵开器钳体	全长235	把	1
3	ZV411R	牵开拉钩	30×16	片	2
4	ZV412R	牵开拉钩	40×16	片	2
5	ZV413R	牵开拉钩	50×16	片	2
6	ZV414R	牵开拉钩	60×16	片	2

椎板咬骨钳  
Kerrison Punch detachable with thin foot



- ★ JF1046RNh 230×2×90°超薄型,可拆式
- ★ JF1047RNh 230×3×90°超薄型,可拆式
- ★ JF1072RNh 200×1×90°超薄型,可拆式
- ★ JF1073RNh 230×1×90°超薄型,可拆式
- ★ JF1054RNh 230×2×110°超薄型,可拆式
- ★ JF1055RNh 230×3×110°超薄型,可拆式
- ★ JF1056RNh 230×4×110°超薄型,可拆式
- ★ JF1059RNh 200×3×130°超薄型,可拆式
- ★ JF1062RNh 230×2×130°超薄型,可拆式
- ★ JF1063RNh 230×3×130°超薄型,可拆式
- ★ JF1064RNh 230×4×130°超薄型,可拆式
- ★ JF1065RNh 230×5×130°超薄型,可拆式
- ★ JF1076RNh 200×1×130°超薄型,可拆式
- ★ JF1077RNh 230×1×130°超薄型,可拆式

椎板咬骨钳(旋转椎板咬骨钳)  
Kerrison Punch, Detachable

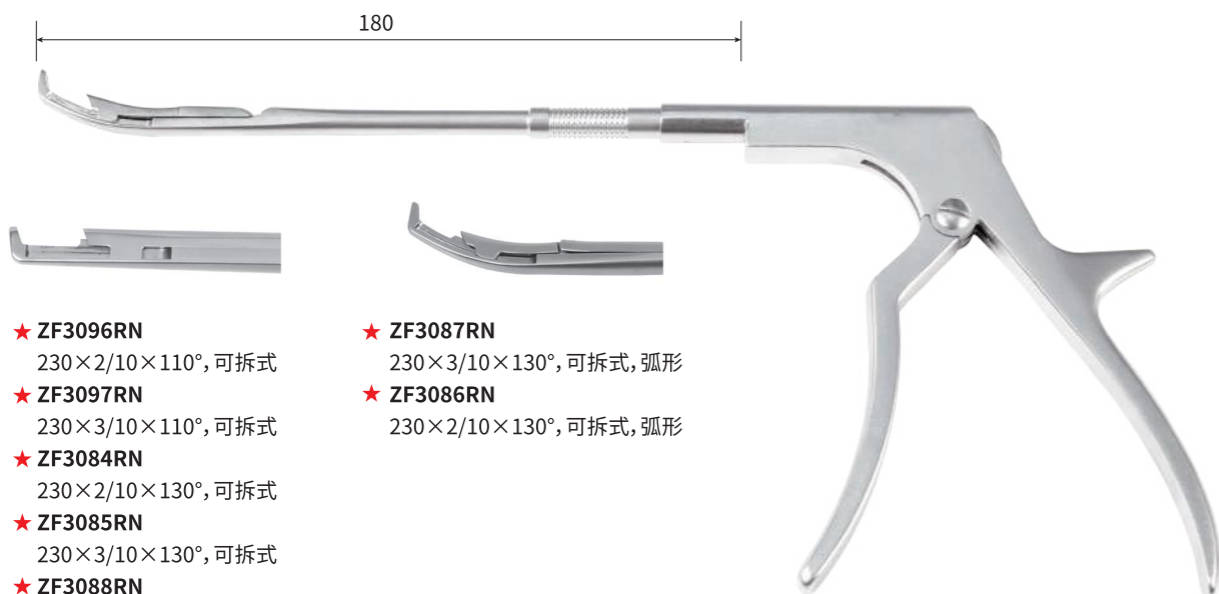

- |                                 |                                    |
|---------------------------------|------------------------------------|
| ★ ZF3096RN<br>230×2/10×110°,可拆式 | ★ ZF3087RN<br>230×3/10×130°,可拆式,弧形 |
| ★ ZF3097RN<br>230×3/10×110°,可拆式 | ★ ZF3086RN<br>230×2/10×130°,可拆式,弧形 |
| ★ ZF3084RN<br>230×2/10×130°,可拆式 |                                    |
| ★ ZF3085RN<br>230×3/10×130°,可拆式 |                                    |
| ★ ZF3088RN<br>230×4/10×130°,可拆式 |                                    |

椎板咬骨钳  
Kerrison Punch, upward curved

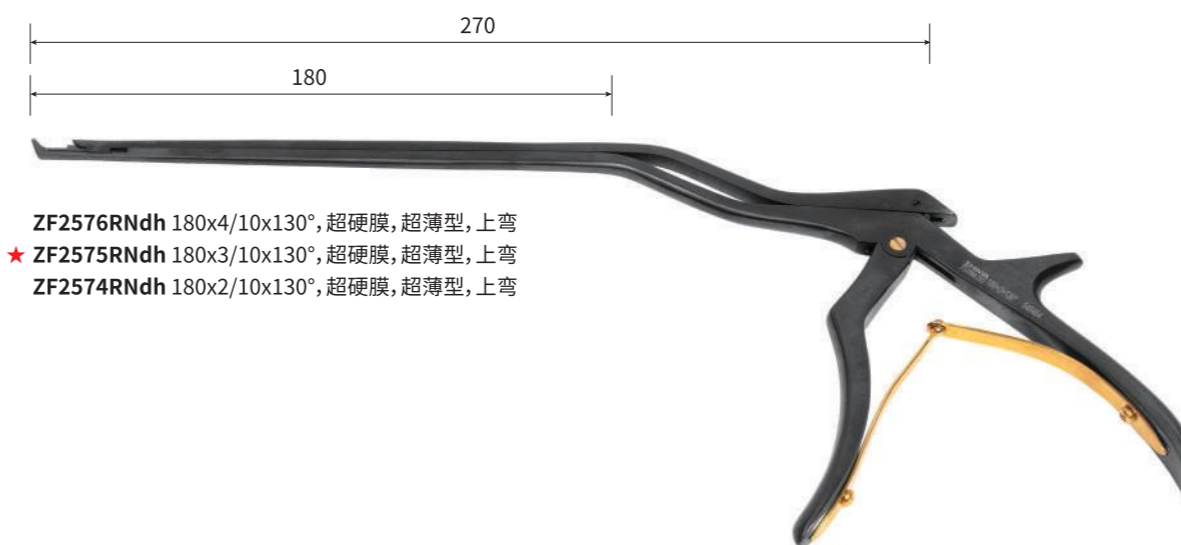

- ZF2576RNdh 180x4/10x130°,超硬膜,超薄型,上弯
- ★ ZF2575RNdh 180x3/10x130°,超硬膜,超薄型,上弯
- ZF2574RNdh 180x2/10x130°,超硬膜,超薄型,上弯

椎板咬骨钳  
Kerrison Punch, left curved



- ZF2584RNdh 180x4/10x130°,超硬膜,超薄型,左弯
- ★ ZF2583RNdh 180x3/10x130°,超硬膜,超薄型,左弯
- ZF2582RNdh 180x2/10x130°,超硬膜,超薄型,左弯

椎板咬骨钳  
Kerrison Punch, right curved

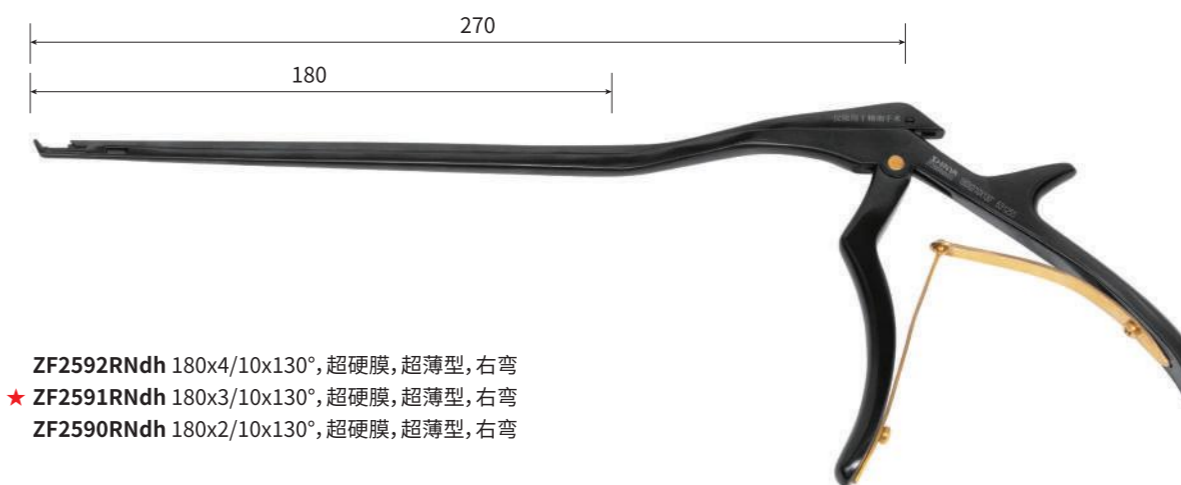

- ZF2592RNdh 180x4/10x130°,超硬膜,超薄型,右弯
- ★ ZF2591RNdh 180x3/10x130°,超硬膜,超薄型,右弯
- ZF2590RNdh 180x2/10x130°,超硬膜,超薄型,右弯

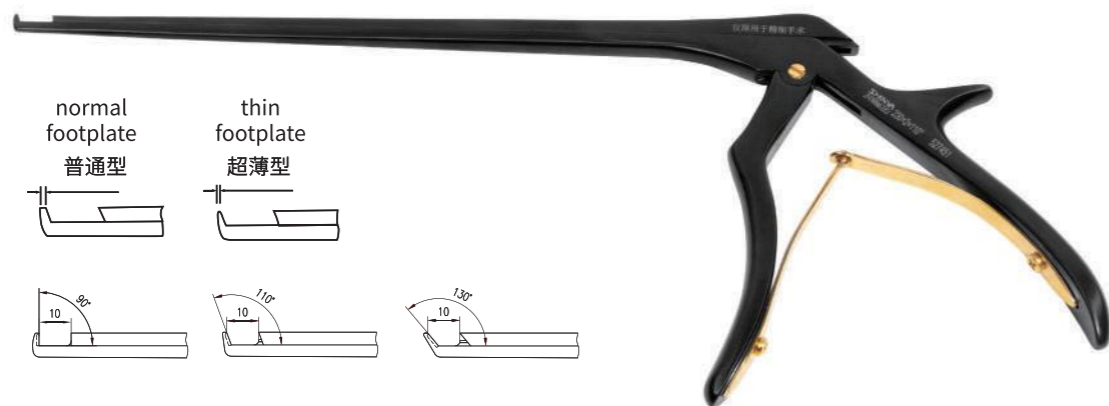

椎板咬骨钳

Kerrison Punch

- |   |   |
|---|---|
| <p><b>normal footplate</b><br/>普通型</p> <ul style="list-style-type: none"> <li>ZF676RNdh 180x2/10x90°, 普通型, 超硬膜</li> <li>ZF748RNdh 200x2/10x90°, 普通型, 超硬膜</li> <li>ZF678RNdh 230x2/10x90°, 普通型, 超硬膜</li> <li>ZF1644RNdh 260x2/10x90°, 普通型, 超硬膜</li> <li>ZF677RNdh 180x3/10x90°, 普通型, 超硬膜</li> <li>ZF749RNdh 200x3/10x90°, 普通型, 超硬膜</li> <li>ZF679RNdh 230x3/10x90°, 普通型, 超硬膜</li> <li>ZF1650RNdh 260x3/10x90°, 普通型, 超硬膜</li> <li>ZF710RNdh 180x4/10x90°, 普通型, 超硬膜</li> <li>ZF753RNdh 200x4/10x90°, 普通型, 超硬膜</li> <li>★ ZF680RNdh 230x4/10x90°, 普通型, 超硬膜</li> <li>ZF1358RNdh 260x4/10x90°, 普通型, 超硬膜</li> <li>ZF536RNdh 180x5/10x90°, 普通型, 超硬膜</li> <li>ZF537RNdh 200x5/10x90°, 普通型, 超硬膜</li> <li>ZF538RNdh 230x5/10x90°, 普通型, 超硬膜</li> <li>ZF1656RNdh 260x5/10x90°, 普通型, 超硬膜</li> <li>ZF681RNsh 180x2/10x110°, 普通型, 超硬膜</li> <li>★ ZF684RNsh 200x2/10x110°, 普通型, 超硬膜</li> <li>★ ZF687RNsh 230x2/10x110°, 普通型, 超硬膜</li> <li>ZF1646RNsh 260x2/10x110°, 普通型, 超硬膜</li> <li>ZF682RNsh 180x3/10x110°, 普通型, 超硬膜</li> <li>★ ZF685RNsh 200x3/10x110°, 普通型, 超硬膜</li> <li>★ ZF688RNsh 230x3/10x110°, 普通型, 超硬膜</li> <li>ZF1652RNsh 260x3/10x110°, 普通型, 超硬膜</li> <li>ZF683RNsh 180x4/10x110°, 普通型, 超硬膜</li> <li>★ ZF686RNsh 200x4/10x110°, 普通型, 超硬膜</li> <li>★ ZF689RNsh 230x4/10x110°, 普通型, 超硬膜</li> <li>ZF1360RNsh 260x4/10x110°, 普通型, 超硬膜</li> <li>ZF539RNsh 180x5/10x110°, 普通型, 超硬膜</li> <li>ZF540RNsh 200x5/10x110°, 普通型, 超硬膜</li> <li>ZF541RNsh 230x5/10x110°, 普通型, 超硬膜</li> <li>ZF1658RNsh 260x5/10x110°, 普通型, 超硬膜</li> <li>ZF690RNsh 180x2/10x130°, 普通型, 超硬膜</li> <li>★ ZF754RNsh 200x2/10x130°, 普通型, 超硬膜</li> <li>★ ZF693RNsh 230x2/10x130°, 普通型, 超硬膜</li> <li>ZF1648RNsh 260x2/10x130°, 普通型, 超硬膜</li> <li>ZF691RNsh 180x3/10x130°, 普通型, 超硬膜</li> <li>★ ZF755RNsh 200x3/10x130°, 普通型, 超硬膜</li> <li>★ ZF694RNsh 230x3/10x130°, 普通型, 超硬膜</li> <li>ZF1654RNsh 260x3/10x130°, 普通型, 超硬膜</li> <li>ZF692RNsh 180x4/10x130°, 普通型, 超硬膜</li> <li>ZF756RNsh 200x4/10x130°, 普通型, 超硬膜</li> <li>★ ZF695RNsh 230x4/10x130°, 普通型, 超硬膜</li> <li>★ ZF1362RNsh 260x4/10x130°, 普通型, 超硬膜</li> <li>ZF542RNsh 180x5/10x130°, 普通型, 超硬膜</li> <li>ZF543RNsh 200x5/10x130°, 普通型, 超硬膜</li> <li>★ ZF795RNsh 230x5/10x130°, 普通型, 超硬膜</li> <li>ZF1660RNsh 260x5/10x130°, 普通型, 超硬膜</li> </ul> | <p><b>thin footplate</b><br/>超薄型</p> <ul style="list-style-type: none"> <li>ZF711RNdh 180x2/10x90°, 超薄型, 超硬膜</li> <li>ZF715RNdh 200x2/10x90°, 超薄型, 超硬膜</li> <li>★ ZF721RNdh 230x2/10x90°, 超薄型, 超硬膜</li> <li>ZF1645RNdh 260x2/10x90°, 超薄型, 超硬膜</li> <li>ZF713RNdh 180x3/10x90°, 超薄型, 超硬膜</li> <li>ZF716RNdh 200x3/10x90°, 超薄型, 超硬膜</li> <li>★ ZF723RNdh 230x3/10x90°, 超薄型, 超硬膜</li> <li>ZF1651RNdh 260x3/10x90°, 超薄型, 超硬膜</li> <li>ZF714RNdh 180x4/10x90°, 超薄型, 超硬膜</li> <li>ZF719RNdh 200x4/10x90°, 超薄型, 超硬膜</li> <li>★ ZF724RNdh 230x4/10x90°, 超薄型, 超硬膜</li> <li>ZF1359RNdh 260x4/10x90°, 超薄型, 超硬膜</li> <li>ZF796RNdh 180x5/10x90°, 超薄型, 超硬膜</li> <li>ZF797RNdh 200x5/10x90°, 超薄型, 超硬膜</li> <li>ZF798RNdh 230x5/10x90°, 超薄型, 超硬膜</li> <li>ZF1657RNdh 260x5/10x90°, 超薄型, 超硬膜</li> <li>ZF751RNsh 180x2/10x110°, 超薄型, 超硬膜</li> <li>★ ZF760RNsh 200x2/10x110°, 超薄型, 超硬膜</li> <li>★ ZF479RNsh 230x2/10x110°, 超薄型, 超硬膜</li> <li>ZF1647RNsh 260x2/10x110°, 超薄型, 超硬膜</li> <li>ZF758RNsh 180x3/10x110°, 超薄型, 超硬膜</li> <li>★ ZF868RNsh 200x3/10x110°, 超薄型, 超硬膜</li> <li>★ ZF480RNsh 230x3/10x110°, 超薄型, 超硬膜</li> <li>ZF1653RNsh 260x3/10x110°, 超薄型, 超硬膜</li> <li>ZF759RNsh 180x4/10x110°, 超薄型, 超硬膜</li> <li>★ ZF869RNsh 200x4/10x110°, 超薄型, 超硬膜</li> <li>★ ZF481RNsh 230x4/10x110°, 超薄型, 超硬膜</li> <li>★ ZF1361RNsh 260x4/10x110°, 超薄型, 超硬膜</li> <li>ZF404RNsh 180x5/10x110°, 超薄型, 超硬膜</li> <li>ZF405RNsh 200x5/10x110°, 超薄型, 超硬膜</li> <li>★ ZF406RNsh 230x5/10x110°, 超薄型, 超硬膜</li> <li>ZF1659RNsh 260x5/10x110°, 超薄型, 超硬膜</li> <li>ZF482RNsh 180x2/10x130°, 超薄型, 超硬膜</li> <li>★ ZF485RNsh 200x2/10x130°, 超薄型, 超硬膜</li> <li>★ ZF488RNsh 230x2/10x130°, 超薄型, 超硬膜</li> <li>★ ZF1649RNsh 260x2/10x130°, 超薄型, 超硬膜</li> <li>★ ZF483RNsh 180x3/10x130°, 超薄型, 超硬膜</li> <li>★ ZF486RNsh 200x3/10x130°, 超薄型, 超硬膜</li> <li>★ ZF489RNsh 230x3/10x130°, 超薄型, 超硬膜</li> <li>★ ZF1655RNsh 260x3/10x130°, 超薄型, 超硬膜</li> <li>ZF484RNsh 180x4/10x130°, 超薄型, 超硬膜</li> <li>★ ZF487RNsh 200x4/10x130°, 超薄型, 超硬膜</li> <li>★ ZF490RNsh 230x4/10x130°, 超薄型, 超硬膜</li> <li>ZF1363RNsh 260x4/10x130°, 超薄型, 超硬膜</li> <li>ZF431RNsh 180x5/10x130°, 超薄型, 超硬膜</li> <li>ZF432RNsh 200x5/10x130°, 超薄型, 超硬膜</li> <li>★ ZF433RNsh 230x5/10x130°, 超薄型, 超硬膜</li> <li>ZF1661RNsh 260x5/10x130°, 超薄型, 超硬膜</li> </ul> |
|---|---|

椎板咬骨钳

Kerrison Punch

- |   |  |
|---|--|
| <p><b>normal footplate</b></p> <ul style="list-style-type: none"> <li>ZF1024RNdh 180x1/10x90°, 普通型, 超硬膜</li> <li>ZF1025RNdh 200x1/10x90°, 普通型, 超硬膜</li> <li>★ ZF1026RNdh 230x1/10x90°, 普通型, 超硬膜</li> <li>ZF1638RNdh 260x1/10x90°, 普通型, 超硬膜</li> <li>ZF1030RNdh 180x1/10x110°, 普通型, 超硬膜</li> <li>ZF1031RNdh 200x1/10x110°, 普通型, 超硬膜</li> <li>ZF1032RNdh 230x1/10x110°, 普通型, 超硬膜</li> <li>ZF1640RNdh 260x1/10x110°, 普通型, 超硬膜</li> <li>ZF799RNdh 180x1/10x130°, 普通型, 超硬膜</li> <li>ZF696RNdh 200x1/10x130°, 普通型, 超硬膜</li> <li>ZF697RNdh 230x1/10x130°, 普通型, 超硬膜</li> <li>ZF1642RNdh 260x1/10x130°, 普通型, 超硬膜</li> </ul> <p><b>thin footplate</b></p> <ul style="list-style-type: none"> <li>ZF1027RNdh 180x1/10x90°, 超薄型, 超硬膜</li> <li>ZF1028RNdh 200x1/10x90°, 超薄型, 超硬膜</li> <li>★ ZF1029RNdh 230x1/10x90°, 超薄型, 超硬膜</li> <li>ZF1639RNdh 260x1/10x90°, 超薄型, 超硬膜</li> <li>ZF1033RNdh 180x1/10x110°, 超薄型, 超硬膜</li> <li>★ ZF1034RNdh 200x1/10x110°, 超薄型, 超硬膜</li> <li>★ ZF1035RNdh 230x1/10x110°, 超薄型, 超硬膜</li> <li>ZF1641RNdh 260x1/10x110°, 超薄型, 超硬膜</li> <li>ZF660RNdh 180x1/10x130°, 超薄型, 超硬膜</li> <li>★ ZF661RNdh 200x1/10x130°, 超薄型, 超硬膜</li> <li>★ ZF662RNdh 230x1/10x130°, 超薄型, 超硬膜</li> <li>ZF1643RNdh 260x1/10x130°, 超薄型, 超硬膜</li> </ul> | <p><b>normal footplate</b></p> <ul style="list-style-type: none"> <li>ZF2055RNdh 180x1.5/10x110°, 普通型, 超硬膜</li> <li>ZF2079RNdh 180x1.5/10x130°, 普通型, 超硬膜</li> <li>ZF2031RNdh 180x1.5/10x90°, 普通型, 超硬膜</li> <li>ZF2061RNsh 180x2.5/10x110°, 普通型, 超硬膜</li> <li>ZF2085RNsh 180x2.5/10x130°, 普通型, 超硬膜</li> <li>ZF2037RNdh 180x2.5/10x90°, 普通型, 超硬膜</li> <li>ZF2067RNsh 180x3.5/10x110°, 普通型, 超硬膜</li> <li>ZF2091RNsh 180x3.5/10x130°, 普通型, 超硬膜</li> <li>ZF2043RNdh 180x3.5/10x90°, 普通型, 超硬膜</li> <li>ZF2073RNsh 180x4.5/10x110°, 普通型, 超硬膜</li> <li>ZF2097RNsh 180x4.5/10x130°, 普通型, 超硬膜</li> <li>ZF2049RNdh 180x4.5/10x90°, 普通型, 超硬膜</li> <li>ZF2057RNdh 200x1.5/10x110°, 普通型, 超硬膜</li> <li>ZF2081RNdh 200x1.5/10x130°, 普通型, 超硬膜</li> <li>ZF2033RNdh 200x1.5/10x90°, 普通型, 超硬膜</li> <li>ZF2063RNsh 200x2.5/10x110°, 普通型, 超硬膜</li> <li>ZF2087RNsh 200x2.5/10x130°, 普通型, 超硬膜</li> <li>ZF2039RNdh 200x2.5/10x90°, 普通型, 超硬膜</li> <li>ZF2069RNsh 200x3.5/10x110°, 普通型, 超硬膜</li> <li>ZF2093RNsh 200x3.5/10x130°, 普通型, 超硬膜</li> <li>ZF2045RNdh 200x3.5/10x90°, 普通型, 超硬膜</li> <li>ZF2075RNsh 200x4.5/10x110°, 普通型, 超硬膜</li> <li>ZF2099RNsh 200x4.5/10x130°, 普通型, 超硬膜</li> <li>ZF2051RNdh 200x4.5/10x90°, 普通型, 超硬膜</li> <li>ZF2059RNdh 230x1.5/10x110°, 普通型, 超硬膜</li> <li>ZF2083RNdh 230x1.5/10x130°, 普通型, 超硬膜</li> <li>ZF2035RNdh 230x1.5/10x90°, 普通型, 超硬膜</li> <li>ZF2065RNsh 230x2.5/10x110°, 普通型, 超硬膜</li> <li>ZF2089RNsh 230x2.5/10x130°, 普通型, 超硬膜</li> <li>ZF2041RNdh 230x2.5/10x90°, 普通型, 超硬膜</li> <li>ZF2071RNsh 230x3.5/10x110°, 普通型, 超硬膜</li> <li>ZF2095RNsh 230x3.5/10x130°, 普通型, 超硬膜</li> <li>ZF2047RNdh 230x3.5/10x90°, 普通型, 超硬膜</li> <li>ZF2077RNsh 230x4.5/10x110°, 普通型, 超硬膜</li> </ul> |
|---|--|

normal footplate

- ZF2101RNsh 230x4.5/10x130°, 普通型, 超硬膜
- ZF2053RNdh 230x4.5/10x90°, 普通型, 超硬膜
- ZF2003RNdh 260x1.5/10x110°, 普通型, 超硬膜
- ZF2005RNdh 260x1.5/10x130°, 普通型, 超硬膜
- ZF2001RNdh 260x1.5/10x90°, 普通型, 超硬膜
- ZF2009RNsh 260x2.5/10x110°, 普通型, 超硬膜
- ZF2011RNsh 260x2.5/10x130°, 普通型, 超硬膜
- ZF2007RNdh 260x2.5/10x90°, 普通型, 超硬膜
- ZF2015RNsh 260x3.5/10x110°, 普通型, 超硬膜
- ZF2017RNsh 260x3.5/10x130°, 普通型, 超硬膜
- ZF2013RNdh 260x3.5/10x90°, 普通型, 超硬膜
- ZF2021RNsh 260x4.5/10x110°, 普通型, 超硬膜
- ZF2023RNsh 260x4.5/10x130°, 普通型, 超硬膜
- ZF2019RNdh 260x4.5/10x90°, 普通型, 超硬膜

thin footplate

- ZF2056RNdh 180x1.5/10x110°, 超薄型, 超硬膜
- ZF2080RNdh 180x1.5/10x130°, 超薄型, 超硬膜
- ZF2032RNdh 180x1.5/10x90°, 超薄型, 超硬膜
- ZF2062RNsh 180x2.5/10x110°, 超薄型, 超硬膜
- ZF2086RNsh 180x2.5/10x130°, 超薄型, 超硬膜
- ZF2038RNdh 180x2.5/10x90°, 超薄型, 超硬膜
- ZF2068RNsh 180x3.5/10x110°, 超薄型, 超硬膜
- ZF2092RNsh 180x3.5/10x130°, 超薄型, 超硬膜
- ZF2044RNdh 180x3.5/10x90°, 超薄型, 超硬膜
- ZF2074RNsh 180x4.5/10x110°, 超薄型, 超硬膜
- ZF2098RNsh 180x4.5/10x130°, 超薄型, 超硬膜
- ZF2050RNdh 180x4.5/10x90°, 超薄型, 超硬膜
- ZF2058RNdh 200x1.5/10x110°, 超薄型, 超硬膜
- ZF2082RNdh 200x1.5/10x130°, 超薄型, 超硬膜
- ZF2034RNdh 200x1.5/10x90°, 超薄型, 超硬膜
- ZF2064RNsh 200x2.5/10x110°, 超薄型, 超硬膜
- ZF2088RNsh 200x2.5/10x130°, 超薄型, 超硬膜
- ZF2040RNdh 200x2.5/10x90°, 超薄型, 超硬膜
- ZF2070RNsh 200x3.5/10x110°, 超薄型, 超硬膜
- ZF2094RNsh 200x3.5/10x130°, 超薄型, 超硬膜
- ZF2046RNdh 200x3.5/10x90°, 超薄型, 超硬膜
- ZF2076RNsh 200x4.5/10x110°, 超薄型, 超硬膜
- ZF2100RNsh 200x4.5/10x130°, 超薄型, 超硬膜
- ZF2052RNdh 200x4.5/10x90°, 超薄型, 超硬膜
- ZF2060RNdh 230x1.5/10x110°, 超薄型, 超硬膜
- ZF2084RNdh 230x1.5/10x130°, 超薄型, 超硬膜
- ZF2036RNdh 230x1.5/10x90°, 超薄型, 超硬膜
- ZF2066RNsh 230x2.5/10x110°, 超薄型, 超硬膜
- ZF2090RNsh 230x2.5/10x130°, 超薄型, 超硬膜
- ZF2042RNdh 230x2.5/10x90°, 超薄型, 超硬膜
- ZF2072RNsh 230x3.5/10x110°, 超薄型, 超硬膜
- ZF2096RNsh 230x3.5/10x130°, 超薄型, 超硬膜
- ZF2048RNdh 230x3.5/10x90°, 超薄型, 超硬膜
- ZF2078RNsh 230x4.5/10x110°, 超薄型, 超硬膜
- ZF2102RNsh 230x4.5/10x130°, 超薄型, 超硬膜
- ZF2054RNdh 230x4.5/10x90°, 超薄型, 超硬膜
- ZF2004RNdh 260x1.5/10x110°, 超薄型, 超硬膜
- ZF2006RNdh 260x1.5/10x130°, 超薄型, 超硬膜
- ZF2002RNdh 260x1.5/10x90°, 超薄型, 超硬膜
- ZF2010RNsh 260x2.5/10x110°, 超薄型, 超硬膜
- ZF2012RNsh 260x2.5/10x130°, 超薄型, 超硬膜
- ZF2008RNdh 260x2.5/10x90°, 超薄型, 超硬膜
- ZF2016RNsh 260x3.5/10x110°, 超薄型, 超硬膜
- ZF2018RNsh 260x3.5/10x130°, 超薄型, 超硬膜
- ZF2014RNdh 260x3.5/10x90°, 超薄型, 超硬膜
- ZF2022RNsh 260x4.5/10x110°, 超薄型, 超硬膜
- ZF2024RNsh 260x4.5/10x130°, 超薄型, 超硬膜
- ZF2020RNdh 260x4.5/10x90°, 超薄型, 超硬膜

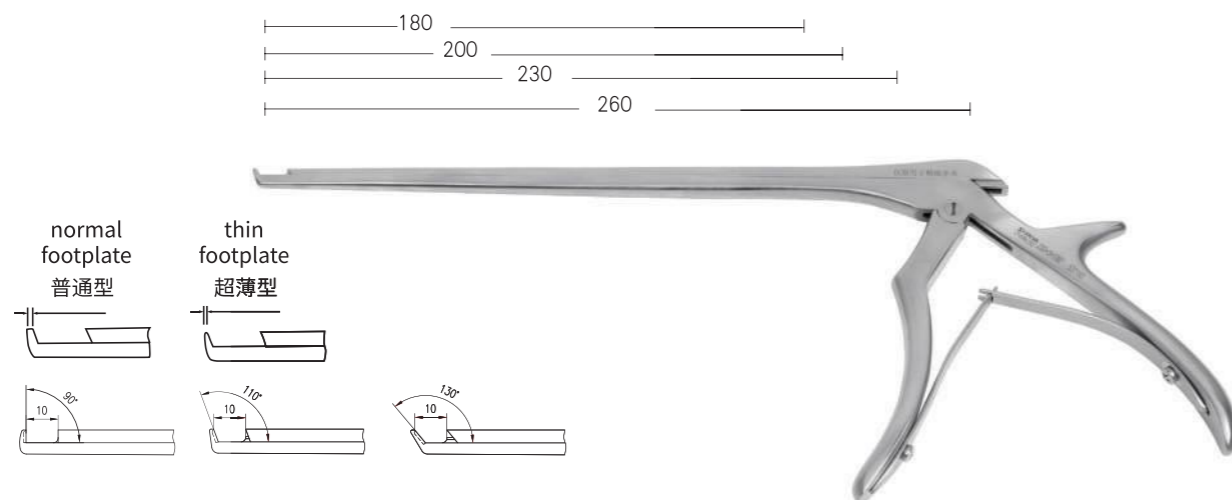

椎板咬骨钳  
Kerrison Punch

normal footplate

- ZF676Rd 180x2/10x90°, 普通型
- ★ZF748Rd 200x2/10x90°, 普通型
- ★ZF678Rd 230x2/10x90°, 普通型
- ★ZF1644Rd 260x2/10x90°, 普通型
- ZF677Rd 180x3/10x90°, 普通型
- ★ZF749Rd 200x3/10x90°, 普通型
- ★ZF679Rd 230x3/10x90°, 普通型
- ★ZF1650Rd 260x3/10x90°, 普通型
- ZF710Rd 180x4/10x90°, 普通型
- ★ZF753Rd 200x4/10x90°, 普通型
- ★ZF680Rd 230x4/10x90°, 普通型
- ★ZF1358Rd 260x4/10x90°, 普通型
- ZF536Rd 180x5/10x90°, 普通型
- ★ZF537Rd 200x5/10x90°, 普通型
- ★ZF538Rd 230x5/10x90°, 普通型
- ZF1656Rd 260x5/10x90°, 普通型
- ZF681Rs 180x2/10x110°, 普通型
- ★ZF684Rs 200x2/10x110°, 普通型
- ★ZF687Rs 230x2/10x110°, 普通型
- ZF1646Rs 260x2/10x110°, 普通型
- ZF682Rs 180x3/10x110°, 普通型
- ★ZF685Rs 200x3/10x110°, 普通型
- ★ZF688Rs 230x3/10x110°, 普通型
- ZF1652Rs 260x3/10x110°, 普通型
- ZF683Rs 180x4/10x110°, 普通型
- ZF686Rs 200x4/10x110°, 普通型
- ★ZF689Rs 230x4/10x110°, 普通型
- ★ZF1360Rs 260x4/10x110°, 普通型
- ZF539Rs 180x5/10x110°, 普通型
- ZF540Rs 200x5/10x110°, 普通型
- ZF541Rs 230x5/10x110°, 普通型
- ZF1658Rs 260x5/10x110°, 普通型
- ZF690Rs 180x2/10x130°, 普通型
- ★ZF754Rs 200x2/10x130°, 普通型
- ★ZF693Rs 230x2/10x130°, 普通型
- ZF1648Rs 260x2/10x130°, 普通型
- ZF691Rs 180x3/10x130°, 普通型
- ★ZF755Rs 200x3/10x130°, 普通型
- ★ZF694Rs 230x3/10x130°, 普通型
- ★ZF1654Rs 260x3/10x130°, 普通型
- ZF692Rs 180x4/10x130°, 普通型

normal footplate

- ★ZF756Rs 200x4/10x130°, 普通型
- ★ZF695Rs 230x4/10x130°, 普通型
- ★ZF1362Rs 260x4/10x130°, 普通型
- ZF542Rs 180x5/10x130°, 普通型
- ZF543Rs 200x5/10x130°, 普通型
- ★ZF795Rs 230x5/10x130°, 普通型
- ZF1660Rs 260x5/10x130°, 普通型

thin footplate

- ZF711Rd 180x2/10x90°, 超薄型
- ★ZF715Rd 200x2/10x90°, 超薄型
- ★ZF721Rd 230x2/10x90°, 超薄型
- ZF1645Rd 260x2/10x90°, 超薄型
- ZF713Rd 180x3/10x90°, 超薄型
- ★ZF716Rd 200x3/10x90°, 超薄型
- ★ZF723Rd 230x3/10x90°, 超薄型
- ZF1651Rd 260x3/10x90°, 超薄型
- ★ZF714Rd 180x4/10x90°, 超薄型
- ZF719Rd 200x4/10x90°, 超薄型
- ★ZF724Rd 230x4/10x90°, 超薄型
- ZF1359Rd 260x4/10x90°, 超薄型
- ZF796Rd 180x5/10x90°, 超薄型
- ZF797Rd 200x5/10x90°, 超薄型
- ZF798Rd 230x5/10x90°, 超薄型
- ZF1657Rd 260x5/10x90°, 超薄型
- ZF751Rs 180x2/10x110°, 超薄型
- ★ZF760Rs 200x2/10x110°, 超薄型
- ★ZF479Rs 230x2/10x110°, 超薄型
- ★ZF1647Rs 260x2/10x110°, 超薄型
- ZF758Rs 180x3/10x110°, 超薄型
- ★ZF868Rs 200x3/10x110°, 超薄型
- ★ZF480Rs 230x3/10x110°, 超薄型
- ★ZF1653Rs 260x3/10x110°, 超薄型
- ZF759Rs 180x4/10x110°, 超薄型
- ★ZF869Rs 200x4/10x110°, 超薄型
- ★ZF481Rs 230x4/10x110°, 超薄型
- ★ZF1361Rs 260x4/10x110°, 超薄型
- ZF404Rs 180x5/10x110°, 超薄型
- ZF405Rs 200x5/10x110°, 超薄型
- ★ZF406Rs 230x5/10x110°, 超薄型
- ZF1659Rs 260x5/10x110°, 超薄型
- ZF482Rs 180x2/10x130°, 超薄型
- ★ZF485Rs 200x2/10x130°, 超薄型

thin footplate

- ★ZF488Rs 230x2/10x130°, 超薄型
- ★ZF1649Rs 260x2/10x130°, 超薄型
- ★ZF483Rs 180x3/10x130°, 超薄型
- ★ZF486Rs 200x3/10x130°, 超薄型
- ★ZF489Rs 230x3/10x130°, 超薄型
- ★ZF1655Rs 260x3/10x130°, 超薄型
- ZF484Rs 180x4/10x130°, 超薄型
- ★ZF487Rs 200x4/10x130°, 超薄型
- ★ZF490Rs 230x4/10x130°, 超薄型
- ★ZF1363Rs 260x4/10x130°, 超薄型
- ZF431Rs 180x5/10x130°, 超薄型
- ZF432Rs 200x5/10x130°, 超薄型
- ★ZF433Rs 230x5/10x130°, 超薄型
- ZF1661Rs 260x5/10x130°, 超薄型

normal footplate

- ZF1024Rd 180x1/10x90°, 普通型
- ZF1025Rd 200x1/10x90°, 普通型
- ★ZF1026Rd 230x1/10x90°, 普通型
- ZF1638Rd 260x1/10x90°, 普通型
- ZF1030Rd 180x1/10x110°, 普通型
- ZF1031Rd 200x1/10x110°, 普通型
- ZF1032Rd 230x1/10x110°, 普通型
- ZF1640Rd 260x1/10x110°, 普通型
- ZF799Rd 180x1/10x130°, 普通型
- ZF696Rd 200x1/10x130°, 普通型
- ZF697Rd 230x1/10x130°, 普通型
- ZF1642Rd 260x1/10x130°, 普通型

thin footplate

- ZF1027Rd 180x1/10x90°, 超薄型
- ZF1028Rd 200x1/10x90°, 超薄型
- ★ZF1029Rd 230x1/10x90°, 超薄型
- ZF1639Rd 260x1/10x90°, 超薄型
- ZF1033Rd 180x1/10x110°, 超薄型
- ★ZF1034Rd 200x1/10x110°, 超薄型
- ★ZF1035Rd 230x1/10x110°, 超薄型
- ZF1641Rd 260x1/10x110°, 超薄型
- ZF660Rd 180x1/10x130°, 超薄型
- ZF661Rd 200x1/10x130°, 超薄型
- ★ZF662Rd 230x1/10x130°, 超薄型
- ★ZF1643Rd 260x1/10x130°, 超薄型

normal footplate

- ZF2055Rd 180x1.5/10x110°, 普通型
- ZF2079Rd 180x1.5/10x130°, 普通型
- ZF2031Rd 180x1.5/10x90°, 普通型
- ZF2061Rs 180x2.5/10x110°, 普通型
- ZF2085Rs 180x2.5/10x130°, 普通型
- ZF2037Rd 180x2.5/10x90°, 普通型
- ZF2067Rs 180x3.5/10x110°, 普通型
- ZF2091Rs 180x3.5/10x130°, 普通型
- ZF2043Rd 180x3.5/10x90°, 普通型
- ZF2073Rs 180x4.5/10x110°, 普通型
- ZF2097Rs 180x4.5/10x130°, 普通型
- ZF2049Rd 180x4.5/10x90°, 普通型
- ZF2057Rs 200x1.5/10x110°, 普通型
- ZF2081Rs 200x1.5/10x130°, 普通型
- ZF2033Rd 200x1.5/10x90°, 普通型
- ZF2063Rs 200x2.5/10x110°, 普通型
- ZF2087Rs 200x2.5/10x130°, 普通型
- ZF2039Rd 200x2.5/10x90°, 普通型
- ZF2069Rs 200x3.5/10x110°, 普通型
- ZF2093Rs 200x3.5/10x130°, 普通型
- ZF2045Rd 200x3.5/10x90°, 普通型
- ZF2075Rs 200x4.5/10x110°, 普通型
- ZF2099Rs 200x4.5/10x130°, 普通型
- ZF2051Rd 200x4.5/10x90°, 普通型
- ZF2059Rd 230x1.5/10x110°, 普通型
- ZF2083Rd 230x1.5/10x130°, 普通型
- ZF2035Rd 230x1.5/10x90°, 普通型
- ZF2065Rs 230x2.5/10x110°, 普通型
- ZF2089Rs 230x2.5/10x130°, 普通型
- ZF2041Rd 230x2.5/10x90°, 普通型
- ZF2071Rs 230x3.5/10x110°, 普通型
- ZF2095Rs 230x3.5/10x130°, 普通型
- ZF2047Rd 230x3.5/10x90°, 普通型
- ZF2077Rs 230x4.5/10x110°, 普通型
- ZF2101Rs 230x4.5/10x130°, 普通型
- ZF2053Rd 230x4.5/10x90°, 普通型
- ZF2003Rd 260x1.5/10x110°, 普通型
- ZF2005Rd 260x1.5/10x130°, 普通型
- ZF2001Rd 260x1.5/10x90°, 普通型
- ZF2009Rs 260x2.5/10x110°, 普通型
- ZF2011Rs 260x2.5/10x130°, 普通型

normal footplate

- ZF2007Rd 260x2.5/10x90°, 普通型
- ZF2015Rs 260x3.5/10x110°, 普通型
- ZF2017Rs 260x3.5/10x130°, 普通型
- ZF2013Rd 260x3.5/10x90°, 普通型
- ZF2021Rs 260x4.5/10x110°, 普通型
- ZF2023Rs 260x4.5/10x130°, 普通型
- ZF2019Rd 260x4.5/10x90°, 普通型

thin footplate

- ZF2056Rd 180x1.5/10x110°, 超薄型
- ZF2080Rd 180x1.5/10x130°, 超薄型
- ZF2032Rd 180x1.5/10x90°, 超薄型
- ZF2062Rs 180x2.5/10x110°, 超薄型
- ZF2086Rs 180x2.5/10x130°, 超薄型
- ZF2038Rd 180x2.5/10x90°, 超薄型
- ZF2068Rs 180x3.5/10x110°, 超薄型
- ZF2092Rs 180x3.5/10x130°, 超薄型
- ZF2044Rd 180x3.5/10x90°, 超薄型
- ZF2074Rs 180x4.5/10x110°, 超薄型
- ZF2098Rs 180x4.5/10x130°, 超薄型
- ZF2050Rd 180x4.5/10x90°, 超薄型
- ZF2058Rd 200x1.5/10x110°, 超薄型
- ZF2082Rd 200x1.5/10x130°, 超薄型
- ZF2034Rd 200x1.5/10x90°, 超薄型
- ZF2064Rs 200x2.5/10x110°, 超薄型
- ZF2088Rs 200x2.5/10x130°, 超薄型
- ZF2040Rd 200x2.5/10x90°, 超薄型
- ZF2070Rs 200x3.5/10x110°, 超薄型
- ZF2094Rs 200x3.5/10x130°, 超薄型
- ZF2046Rd 200x3.5/10x90°, 超薄型
- ZF2076Rs 200x4.5/10x110°, 超薄型
- ZF2100Rs 200x4.5/10x130°, 超薄型
- ZF2052Rd 200x4.5/10x90°, 超薄型
- ZF2060Rd 230x1.5/10x110°, 超薄型
- ZF2084Rd 230x1.5/10x130°, 超薄型
- ZF2036Rd 230x1.5/10x90°, 超薄型
- ZF2066Rs 230x2.5/10x110°, 超薄型
- ZF2090Rs 230x2.5/10x130°, 超薄型
- ZF2042Rd 230x2.5/10x90°, 超薄型
- ZF2072Rs 230x3.5/10x110°, 超薄型
- ZF2096Rs 230x3.5/10x130°, 超薄型
- ZF2048Rd 230x3.5/10x90°, 超薄型
- ZF2078Rs 230x4.5/10x110°, 超薄型

thin footplate

- ZF2102Rs 230x4.5/10x130°, 超薄型
- ZF2054Rd 230x4.5/10x90°, 超薄型
- ZF2004Rd 260x1.5/10x110°, 超薄型
- ZF2006Rd 260x1.5/10x130°, 超薄型
- ZF2002Rd 260x1.5/10x90°, 超薄型
- ZF2010Rs 260x2.5/10x110°, 超薄型
- ZF2012Rs 260x2.5/10x130°, 超薄型
- ZF2008Rd 260x2.5/10x90°, 超薄型
- ZF2016Rs 260x3.5/10x110°, 超薄型
- ZF2018Rs 260x3.5/10x130°, 超薄型
- ZF2014Rd 260x3.5/10x90°, 超薄型
- ZF2022Rs 260x4.5/10x110°, 超薄型
- ZF2024Rs 260x4.5/10x130°, 超薄型
- ZF2020Rd 260x4.5/10x90°, 超薄型

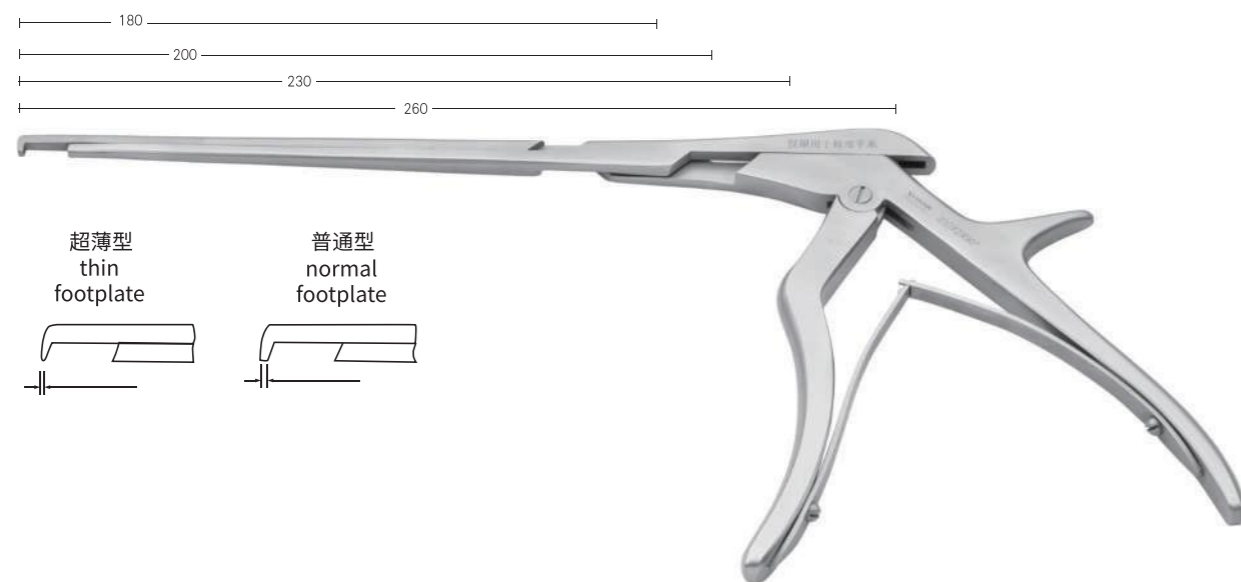

反扣式椎板咬骨钳  
Kerrison Punch downward cutting

thin footplate		thin footplate		normal footplate	
ZF491RN	180x2/10x90°, 超薄型	★ ZF516RN	230x3/10x130°, 超薄型	ZF738RN	230x3/10x110°, 普通型
ZF494RN	200x2/10x90°, 超薄型	ZF511RN	180x4/10x130°, 超薄型	ZF733RN	180x4/10x110°, 普通型
ZF497RN	230x2/10x90°, 超薄型	★ ZF514RN	200x4/10x130°, 超薄型	ZF736RN	200x4/10x110°, 普通型
ZF492RN	180x3/10x90°, 超薄型	★ ZF517RN	230x4/10x130°, 超薄型	ZF739RN	230x4/10x110°, 普通型
ZF495RN	200x3/10x90°, 超薄型	ZF533RN	180x5/10x130°, 超薄型	ZF521RN	180x5/10x110°, 普通型
ZF498RN	230x3/10x90°, 超薄型	ZF534RN	200x5/10x130°, 超薄型	ZF522RN	200x5/10x110°, 普通型
ZF493RN	180x4/10x90°, 超薄型	ZF535RN	230x5/10x130°, 超薄型	ZF523RN	230x5/10x110°, 普通型
ZF496RN	200x4/10x90°, 超薄型			ZF740RN	180x2/10x130°, 普通型
ZF499RN	230x4/10x90°, 超薄型			ZF743RN	200x2/10x130°, 普通型
ZF527RN	180x5/10x90°, 超薄型			ZF746RN	230x2/10x130°, 普通型
ZF528RN	200x5/10x90°, 超薄型			ZF741RN	180x3/10x130°, 普通型
ZF529RN	230x5/10x90°, 超薄型			ZF744RN	200x3/10x130°, 普通型
ZF500RN	180x2/10x110°, 超薄型			ZF747RN	230x3/10x130°, 普通型
★ ZF503RN	200x2/10x110°, 超薄型			ZF742RN	180x4/10x130°, 普通型
★ ZF506RN	230x2/10x110°, 超薄型			ZF745RN	200x4/10x130°, 普通型
ZF501RN	180x3/10x110°, 超薄型			ZF794RN	230x4/10x130°, 普通型
★ ZF504RN	200x3/10x110°, 超薄型			ZF524RN	180x5/10x130°, 普通型
★ ZF507RN	230x3/10x110°, 超薄型			ZF525RN	200x5/10x130°, 普通型
ZF502RN	180x4/10x110°, 超薄型			ZF526RN	230x5/10x130°, 普通型
ZF505RN	200x4/10x110°, 超薄型				
ZF508RN	230x4/10x110°, 超薄型				
ZF530RN	180x5/10x110°, 超薄型				
ZF531RN	200x5/10x110°, 超薄型				
ZF532RN	230x5/10x110°, 超薄型				
ZF509RN	180x2/10x130°, 超薄型				
★ ZF512RN	200x2/10x130°, 超薄型				
★ ZF515RN	230x2/10x130°, 超薄型				
ZF510RN	180x3/10x130°, 超薄型				
★ ZF513RN	200x3/10x130°, 超薄型				

弧形椎板咬骨钳  
Kerrison Punch

normal footplate	
ZF1662Rd	180x2x90°, 普通型
ZF1668Rd	180x3x90°, 普通型
ZF1674Rd	180x4x90°, 普通型
ZF1680Rd	180x5x90°, 普通型
ZF1664Rd	180x2x110°, 普通型
ZF1670Rd	180x3x110°, 普通型
ZF1676Rd	180x4x110°, 普通型
ZF1682Rd	180x5x110°, 普通型



大开口椎板咬骨钳  
Kerrison Punch normal footplate

normal footplate		thin footplate	
ZF1686RN	180x2/15x90°, 普通型	ZF1666Rd	180x2x130°, 普通型
ZF1690RN	200x2/15x90°, 普通型	ZF1672Rd	180x3x130°, 普通型
ZF1694RN	230x2/15x90°, 普通型	ZF1678Rd	180x4x130°, 普通型
ZF1698RN	260x2/15x90°, 普通型	ZF1684Rd	180x5x130°, 普通型
ZF1687RN	180x3/15x90°, 普通型		
ZF1691RN	200x3/15x90°, 普通型		
ZF1695RN	230x3/15x90°, 普通型		
ZF1699RN	260x3/15x90°, 普通型		
ZF1688RN	180x4/15x90°, 普通型		
ZF1692RN	200x4/15x90°, 普通型		
ZF1696RN	230x4/15x90°, 普通型		
ZF1700RN	260x4/15x90°, 普通型		
ZF1689RN	180x5/15x90°, 普通型		
ZF1693RN	200x5/15x90°, 普通型		
ZF1697RN	230x5/15x90°, 普通型		
ZF1701RN	260x5/15x90°, 普通型		
ZF1702RN	180x2/15x110°, 普通型		
ZF1706RN	200x2/15x110°, 普通型		
★ ZF1710RN	230x2/15x110°, 普通型		
ZF1714RN	260x2/15x110°, 普通型		
ZF1703RN	180x3/15x110°, 普通型		
ZF1707RN	200x3/15x110°, 普通型		
★ ZF1711RN	230x3/15x110°, 普通型		
ZF1715RN	260x3/15x110°, 普通型		
ZF1704RN	180x4/15x110°, 普通型		
ZF1708RN	200x4/15x110°, 普通型		
ZF1712RN	230x4/15x110°, 普通型		
ZF1716RN	260x4/15x110°, 普通型		
ZF1705RN	180x5/15x110°, 普通型		
ZF1709RN	200x5/15x110°, 普通型		
ZF1713RN	230x5/15x110°, 普通型		
ZF1717RN	260x5/15x110°, 普通型		
ZF1718RN	180x2/15x130°, 普通型		
ZF1722RN	200x2/15x130°, 普通型		
★ ZF1726RN	230x2/15x130°, 普通型		
ZF1730RN	260x2/15x130°, 普通型		
ZF1719RN	180x3/15x130°, 普通型		
ZF1723RN	200x3/15x130°, 普通型		
★ ZF1727RN	230x3/15x130°, 普通型		
ZF1731RN	260x3/15x130°, 普通型		
ZF1720RN	180x4/15x130°, 普通型		
ZF1724RN	200x4/15x130°, 普通型		
★ ZF1728RN	230x4/15x130°, 普通型		
ZF1732RN	260x4/15x130°, 普通型		
ZF1721RN	180x5/15x130°, 普通型		
ZF1725RN	200x5/15x130°, 普通型		
ZF1729RN	230x5/15x130°, 普通型		
ZF1733RN	260x5/15x130°, 普通型		

髓核钳 (指圈式)  
Laminectomy Rongeur



- |                   |                       |                        |
|-------------------|-----------------------|------------------------|
| ZF825RG 160x2x10  | ZF889RG 200x5x10      | ZF808RG 180x4x10x150°  |
| ZF826RG 160x3x10  | ZF1037RG 220x1x10     | ZF809RG 180x5x10x150°  |
| ZF827RG 160x4x10  | ★ZF890RG 220x2x10     | ZF839RG 200x2x10x150°  |
| ZF847RG 160x5x10  | ★ZF834RG 220x3x10     | ★ZF979RG 200x3x10x150° |
| ★ZF821RG 180x2x10 | ★ZF823RG 220x4x10     | ZF980RG 200x4x10x150°  |
| ★ZF805RG 180x3x10 | ★ZF861RG 220x5x10     | ZF981RG 200x5x10x150°  |
| ★ZF806RG 180x4x10 | ZF835RG 160x2x10x150° | ★ZF982RG 220x2x10x150° |
| ZF824RG 180x5x10  | ZF836RG 160x3x10x150° | ★ZF983RG 220x3x10x150° |
| ★ZF848RG 200x2x10 | ZF837RG 160x4x10x150° | ★ZF984RG 220x4x10x150° |
| ★ZF849RG 200x3x10 | ZF838RG 160x5x10x150° | ★ZF985RG 220x5x10x150° |
| ★ZF888RG 200x4x10 | ZF822RG 180x2x10x150° |                        |
|                   | ZF807RG 180x3x10x150° |                        |

髓核钳 (指圈式)  
Laminectomy Rongeur



- |                       |                             |                            |
|-----------------------|-----------------------------|----------------------------|
| ZF1747RG 220x2x10, 有齿 | ZF1750RG 220x5x10, 有齿       | ZF1753RG 220x4x10x150°, 有齿 |
| ZF1748RG 220x3x10, 有齿 | ZF1751RG 220x2x10x150°, 有齿  | ZF1754RG 220x5x10x150°, 有齿 |
| ZF1749RG 220x4x10, 有齿 | ★ZF1752RG 220x3x10x150°, 有齿 |                            |

弧形髓核钳  
Laminectomy Rongeur



- |                       |                        |
|-----------------------|------------------------|
| ZF1742Rd 260x2x6, 握柄式 | ★ZF666Rd 260x4x10, 握柄式 |
| ZF1743Rd 260x3x8, 握柄式 | ZF1744Rd 260x5x12, 握柄式 |



- |                                 |                                 |
|---------------------------------|---------------------------------|
| ZF1757Rd 220x2x6, 握柄式, 有齿       | ZF1767Rd 260x2x6, 握柄式, 有齿       |
| ★ZF1758Rd 220x3x8, 握柄式, 有齿      | ZF1768Rd 260x3x8, 握柄式, 有齿       |
| ★ZF1759Rd 220x4x10, 握柄式, 有齿     | ZF1769Rd 260x4x10, 握柄式, 有齿      |
| ZF1760Rd 220x5x12, 握柄式, 有齿      | ZF1770Rd 260x5x12, 握柄式, 有齿      |
| ZF1761Rd 220x2x6x150°, 握柄式, 有齿  | ZF1771Rd 260x2x6x150°, 握柄式, 有齿  |
| ★ZF1762Rd 220x3x8x150°, 握柄式, 有齿 | ZF1772Rd 260x3x8x150°, 握柄式, 有齿  |
| ZF1763Rd 220x4x10x150°, 握柄式, 有齿 | ZF1773Rd 260x4x10x150°, 握柄式, 有齿 |
| ZF1764R 220x5x12x150°, 握柄式, 有齿  | ZF1774Rd 260x5x12x150°, 握柄式, 有齿 |



髓核钳  
Laminectomy Rongeur

- ZF567RNdH 160×2×6, 握柄式, 超硬膜
- ★ZF568RNdH 180×2×6, 握柄式, 超硬膜
- ★ZF569RNdH 200×2×6, 握柄式, 超硬膜
- ★ZF570RNdH 220×2×6, 握柄式, 超硬膜
- ZF571RNdH 160×3×8, 握柄式, 超硬膜
- ★ZF572RNdH 180×3×8, 握柄式, 超硬膜
- ★ZF573RNdH 200×3×8, 握柄式, 超硬膜
- ★ZF574RNdH 220×3×8, 握柄式, 超硬膜
- ZF575RNdH 160×4×10, 握柄式, 超硬膜
- ZF576RNdH 180×4×10, 握柄式, 超硬膜
- ★ZF577RNdH 200×4×10, 握柄式, 超硬膜
- ★ZF578RNdH 220×4×10, 握柄式, 超硬膜
- ZF579RNdH 160×5×12, 握柄式, 超硬膜
- ZF580RNdH 180×5×12, 握柄式, 超硬膜
- ZF581RNdH 200×5×12, 握柄式, 超硬膜
- ★ZF582RNdH 220×5×12, 握柄式, 超硬膜
- ZF583RNdH 160×2×6×150°, 握柄式, 超硬膜
- ZF584RNdH 180×2×6×150°, 握柄式, 超硬膜
- ZF585RNdH 200×2×6×150°, 握柄式, 超硬膜
- ★ZF586RNdH 220×2×6×150°, 握柄式, 超硬膜
- ZF587RNdH 160×3×8×150°, 握柄式, 超硬膜
- ZF588RNdH 180×3×8×150°, 握柄式, 超硬膜
- ★ZF589RNdH 200×3×8×150°, 握柄式, 超硬膜
- ★ZF590RNdH 220×3×8×150°, 握柄式, 超硬膜
- ZF591RNdH 160×4×10×150°, 握柄式, 超硬膜
- ZF592RNdH 180×4×10×150°, 握柄式, 超硬膜
- ZF593RNdH 200×4×10×150°, 握柄式, 超硬膜
- ★ZF594RNdH 220×4×10×150°, 握柄式, 超硬膜
- ZF595RNdH 160×5×12×150°, 握柄式, 超硬膜
- ZF596RNdH 180×5×12×150°, 握柄式, 超硬膜
- ZF597RNdH 200×5×12×150°, 握柄式, 超硬膜
- ZF659RNdH 220×5×12×150°, 握柄式, 超硬膜
- ★ZF1735RNdH 260×2×6, 握柄式, 超硬膜
- ★ZF1736RNdH 260×3×8, 握柄式, 超硬膜
- ★ZF1737RNdH 260×4×10, 握柄式, 超硬膜
- ZF1738RNdH 260×5×12, 握柄式, 超硬膜
- ZF1739RNdH 260×2×6×150°, 握柄式, 超硬膜

- ZF1740RNdH 260×3×8×150°, 握柄式, 超硬膜
- ZF665RNdH 260×4×10×150°, 握柄式, 超硬膜
- ZF1741RNdH 260×5×12×150°, 握柄式, 超硬膜
- ZF2500RNdH 160×2.5×8, 握柄式, 超硬膜
- ZF2504RNdH 160×3.5×10, 握柄式, 超硬膜
- ZF2508RNdH 160×4.5×12, 握柄式, 超硬膜
- ZF2501RNdH 180×2.5×8, 握柄式, 超硬膜
- ZF2505RNdH 180×3.5×10, 握柄式, 超硬膜
- ZF2509RNdH 180×4.5×12, 握柄式, 超硬膜
- ZF2502RNdH 200×2.5×8, 握柄式, 超硬膜
- ZF2506RNdH 200×3.5×10, 握柄式, 超硬膜
- ZF2510RNdH 200×4.5×12, 握柄式, 超硬膜
- ZF2503RNdH 220×2.5×8, 握柄式, 超硬膜
- ZF2507RNdH 220×3.5×10, 握柄式, 超硬膜
- ZF2511RNdH 220×4.5×12, 握柄式, 超硬膜
- ZF2512RNdH 160×2.5×8×150°, 握柄式, 超硬膜
- ZF2516RNdH 160×3.5×10×150°, 握柄式, 超硬膜
- ZF2520RNdH 160×4.5×12×150°, 握柄式, 超硬膜
- ZF2513RNdH 180×2.5×8×150°, 握柄式, 超硬膜
- ZF2517RNdH 180×3.5×10×150°, 握柄式, 超硬膜
- ZF2521RNdH 180×4.5×12×150°, 握柄式, 超硬膜
- ZF2514RNdH 200×2.5×8×150°, 握柄式, 超硬膜
- ZF2518RNdH 200×3.5×10×150°, 握柄式, 超硬膜
- ZF2522RNdH 200×4.5×12×150°, 握柄式, 超硬膜
- ZF2515RNdH 220×2.5×8×150°, 握柄式, 超硬膜
- ZF2519RNdH 220×3.5×10×150°, 握柄式, 超硬膜
- ZF2523RNdH 220×4.5×12×150°, 握柄式, 超硬膜
- ZF1778RNdH 260×2.5×8, 握柄式, 超硬膜
- ZF1779RNdH 260×3.5×10, 握柄式, 超硬膜
- ZF1780RNdH 260×4.5×12, 握柄式, 超硬膜
- ZF1782RNdH 260×2.5×8×150°, 握柄式, 超硬膜
- ZF1783RNdH 260×3.5×10×150°, 握柄式, 超硬膜
- ZF1784RNdH 260×4.5×12×150°, 握柄式, 超硬膜

髓核钳  
Laminectomy Rongeur

- ZF567Rd 160×2×6, 握柄式
- ★ZF568Rd 180×2×6, 握柄式
- ★ZF569Rd 200×2×6, 握柄式
- ZF1038Rd 220×1×6, 握柄式
- ★ZF570Rd 220×2×6, 握柄式
- ★ZF571Rd 160×3×8, 握柄式
- ★ZF572Rd 180×3×8, 握柄式
- ★ZF573Rd 200×3×8, 握柄式
- ★ZF574Rd 220×3×8, 握柄式
- ZF575Rd 160×4×10, 握柄式
- ★ZF576Rd 180×4×10, 握柄式
- ★ZF577Rd 200×4×10, 握柄式
- ★ZF578Rd 220×4×10, 握柄式
- ZF579Rd 160×5×12, 握柄式
- ZF580Rd 180×5×12, 握柄式
- ★ZF581Rd 200×5×12, 握柄式
- ★ZF582Rd 220×5×12, 握柄式
- ZF583Rd 160×2×6×150°, 握柄式
- ZF584Rd 180×2×6×150°, 握柄式
- ★ZF585Rd 200×2×6×150°, 握柄式
- ★ZF586Rd 220×2×6×150°, 握柄式
- ZF587Rd 160×3×8×150°, 握柄式
- ZF588Rd 180×3×8×150°, 握柄式
- ★ZF589Rd 200×3×8×150°, 握柄式
- ★ZF590Rd 220×3×8×150°, 握柄式
- ZF591Rd 160×4×10×150°, 握柄式
- ZF592Rd 180×4×10×150°, 握柄式
- ★ZF593Rd 200×4×10×150°, 握柄式

- ★ZF594Rd 220×4×10×150°, 握柄式
- ZF595Rd 160×5×12×150°, 握柄式
- ZF596Rd 180×5×12×150°, 握柄式
- ★ZF597Rd 200×5×12×150°, 握柄式
- ★ZF659Rd 220×5×12×150°, 握柄式
- ★ZF1735Rd 260×2×6, 握柄式
- ★ZF1736Rd 260×3×8, 握柄式
- ★ZF1737Rd 260×4×10, 握柄式
- ZF1738Rd 260×5×12, 握柄式
- ZF1739Rd 260×2×6×150°, 握柄式
- ZF1740Rd 260×3×8×150°, 握柄式
- ZF665Rd 260×4×10×150°, 握柄式
- ZF1741Rd 260×5×12×150°, 握柄式
- ZF2500Rd 160×2.5×8, 握柄式
- ZF2504Rd 160×3.5×10, 握柄式
- ZF2508Rd 160×4.5×12, 握柄式
- ZF2501Rd 180×2.5×8, 握柄式
- ZF2505Rd 180×3.5×10, 握柄式
- ZF2509Rd 180×4.5×12, 握柄式
- ZF2502Rd 200×2.5×8, 握柄式
- ZF2506Rd 200×3.5×10, 握柄式
- ZF2510Rd 200×4.5×12, 握柄式
- ZF2503Rd 220×2.5×8, 握柄式
- ZF2507Rd 220×3.5×10, 握柄式
- ZF2511Rd 220×4.5×12, 握柄式
- ZF2512Rd 160×2.5×8×150°, 握柄式
- ZF2516Rd 160×3.5×10×150°, 握柄式
- ZF2520Rd 160×4.5×12×150°, 握柄式
- ZF2513Rd 180×2.5×8×150°, 握柄式
- ZF2517Rd 180×3.5×10×150°, 握柄式
- ZF2521Rd 180×4.5×12×150°, 握柄式
- ZF2514Rd 200×2.5×8×150°, 握柄式
- ZF2518Rd 200×3.5×10×150°, 握柄式
- ZF2522Rd 200×4.5×12×150°, 握柄式
- ZF2515Rd 220×2.5×8×150°, 握柄式
- ZF2519Rd 220×3.5×10×150°, 握柄式
- ZF2523Rd 220×4.5×12×150°, 握柄式
- ZF1778Rd 260×2.5×8, 握柄式
- ZF1779Rd 260×3.5×10, 握柄式
- ZF1780Rd 260×4.5×12, 握柄式
- ZF1782Rd 260×2.5×8×150°, 握柄式
- ZF1783Rd 260×3.5×10×150°, 握柄式
- ZF1784Rd 260×4.5×12×150°, 握柄式

髓核钳  
Laminectomy rongeur, total shaft length 200mm



ZF3043R Nh 200×2×8, 上弯, 指圈式

ZF3044RNh 200×3×8, 上弯, 指圈式

ZF3041R Nh 200×2×8×150°, 上弯, 指圈式

ZF3042RNh 200×3×8×150°, 上弯, 指圈式

髓核钳  
Laminectomy Rongeur

- ★ JF574RB 220x3
- ★ JF578RB 220x4
- ★ JF590RB 220x3x150°
- ★ JF594RB 220x4x150°



髓核钳 (精细型)  
Laminectomy Rongeur



- ★ ZF3074RN 220×3, 直型, 握柄式
- ★ ZF3075RN 220×3×150°, 握柄式
- ★ ZF3078RN 220×4, 直型, 握柄式
- ★ ZF3079RN 220×4×150°, 握柄式

髓核钳  
Laminectomy Rongeur, fine shaft



- ★ ZF3089RN 230×2, 直型, 指圈式
- ★ ZF3090RN 230×2×150°, 指圈式

双关节咬骨钳  
Bone Rongeur



- ★ JK637RT 240x3, 直尖头 straight
- ★ JK641RT 240x3, 弯尖头 curved

双关节咬骨钳  
Bone Rongeur



- ★ JK585RT 240x2直头 straight
- ★ JK606RT 240x3直头 straight
- ★ JK587RT 240x4直头 straight
- ★ JK588RT 240x5直头 straight
- JK793RT 240x6直头 straight
- ★ JK589RT 240x2弯头 curved
- ★ JK590RT 240x3弯头 curved
- ★ JK591RT 240x4弯头 curved
- ★ JK592RT 240x5弯头 curved
- ★ JK593RT 240x2x38°弯头 curved
- ★ JK595RT 240x4x38°弯头 curved
- ★ JK794RT 240x6弯头 curved

双关节咬骨钳  
Bone Rongeur



- ★ JK437RT 240x6直头 straight
- ★ JK438RT 240x6弯头 curved
- ★ JK439RT 240x7直头 straight
- JK440RT 240x7弯头 curved
- ★ JK435RT 240x8直头 straight
- ★ JK436RT 240x8弯头 curved

双关节咬骨钳  
Bone Rongeur



- |   |  |
|---|--|
| ZK575R/RNh 160x2, 直头, 双关节 straight          | ZK771R/RNh 200x4x38°, 弯头, 双关节 curved         |
| ZK576R/RNh 160x2x20°, 弯头, 双关节 curved        | ZK752R/RNh 200x5, 直头, 双关节 straight           |
| ZK632R/RNh 160x2x38°, 弯头, 双关节 curved        | ZK767R/RNh 200x5x20°, 弯头, 双关节 curved         |
| ZK682R/RNh 160x3, 直头, 双关节 straight          | ZK768R/RNh 200x5x38°, 弯头, 双关节 curved         |
| ZK685R/RNh 160x3, 直尖头, 双关节 straight,sharp   | ★ZK605R/RNh 220x2, 直头, 双关节 straight          |
| ZK683R/RNh 160x3x20°, 弯头, 双关节 curved        | ★ZK597R/RNh 220x2x20°, 弯头, 双关节 curved        |
| ZK686R/RNh 160x3x20°, 弯尖头, 双关节 curved,sharp | ZK601R/RNh 220x2x38°, 弯头, 双关节 curved         |
| ZK684R/RNh 160x3x38°, 弯头, 双关节 curved        | ★ZK606R/RNh 220x3, 直头, 双关节 straight          |
| ZK687R/RNh 160x3x38°, 弯尖头, 双关节 curved,sharp | ★ZK798R/RNh 220x3, 直尖头, 双关节 straight,sharp   |
| ★ZK648R/RNh 180x2, 直头, 双关节 straight         | ★ZK598R/RNh 220x3x20°, 弯头, 双关节 curved        |
| ★ZK569R/RNh 180x2x20°, 弯头, 双关节 curved       | ★ZK799R/RNh 220x3x20°, 弯尖头, 双关节 curved,sharp |
| ZK568R/RNh 180x2x38°, 弯头, 双关节 curved        | ZK602R/RNh 220x3x38°, 弯头, 双关节 curved         |
| ★ZK649R/RNh 180x3, 直头, 双关节 straight         | ZK800R/RNh 220x3x38°, 弯尖头, 双关节 curved,sharp  |
| ★ZK457R/RNh 180x3, 直尖头, 双关节 straight,sharp  | ★ZK607R/RNh 220x4, 直头, 双关节 straight          |
| ★ZK652R/RNh 180x3x20°, 弯头, 双关节 curved       | ★ZK599R/RNh 220x4x20°, 弯头, 双关节 curved        |
| ZK458R/RNh 180x3x20°, 弯尖头, 双关节 curved,sharp | ZK603R/RNh 220x4x38°, 弯头, 双关节 curved         |
| ZK655R/RNh 180x3x38°, 弯头, 双关节 curved        | ★ZK608R/RNh 220x5, 直头, 双关节 straight          |
| ZK459R/RNh 180x3x38°, 弯尖头, 双关节 curved,sharp | ★ZK600R/RNh 220x5x20°, 弯头, 双关节 curved        |
| ★ZK650R/RNh 180x4, 直头, 双关节 straight         | ZK604R/RNh 220x5x38°, 弯头, 双关节 curved         |
| ★ZK653R/RNh 180x4x20°, 弯头, 双关节 curved       | ★ZK585R/RNh 240x2, 直头, 双关节 straight          |
| ZK656R/RNh 180x4x38°, 弯头, 双关节 curved        | ★ZK589R/RNh 240x2x20°, 弯头, 双关节 curved        |
| ★ZK651R/RNh 180x5, 直头, 双关节 straight         | ZK593R/RNh 240x2x38°, 弯头, 双关节 curved         |
| ★ZK654R/RNh 180x5x20°, 弯头, 双关节 curved       | ★ZK586R/RNh 240x3, 直头, 双关节 straight          |
| ZK657R/RNh 180x5x38°, 弯头, 双关节 curved        | ★ZK637R/RNh 240x3, 直尖头, 双关节 straight,sharp   |
| ZK775R/RNh 200x2, 直头, 双关节 straight          | ★ZK590R/RNh 240x3x20°, 弯头, 双关节 curved        |
| ZKT76R/RNh 200x2x20°, 弯头, 双关节 curved        | ★ZK641R/RNh 240x3x20°, 弯尖头, 双关节 curved,sharp |
| ZK777R/RNh 200x2x38°, 弯头, 双关节 curved        | ZK594R/RNh 240x3x38°, 弯头, 双关节 curved         |
| ZK772R/RNh 200x3, 直头, 双关节 straight          | ZK645R/RNh 240x3x38°, 弯尖头, 双关节 curved,sharp  |
| ZK795R/RNh 200x3, 直尖头, 双关节 curved,sharp     | ★ZK587R/RNh 240x4, 直头, 双关节 straight          |
| ZK773R/RNh 200x3x20°, 弯头, 双关节 curved        | ★ZK591R/RNh 240x4x20°, 弯头, 双关节 curved        |
| ZK796R/RNh 200x3x20°, 弯尖头, 双关节 curved,sharp | ZK595R/RNh 240x4x38°, 弯头, 双关节 curved         |
| ZK774R/RNh 200x3x38°, 弯头, 双关节 curved        | ★ZK588R/RNh 240x5, 直头, 双关节 straight          |
| ZK797R/RNh 200x3x38°, 弯尖头, 双关节 curved,sharp | ★ZK592R/RNh 240x5x20°, 弯头, 双关节 curved        |
| ZK769R/RNh 200x4, 直头, 双关节 straight          | ZK596R/RNh 240x5x38°, 弯头, 双关节 curved         |
| ZK770R/RNh 200x4x20°, 弯头, 双关节 curved        |  |

注：“RNh”后缀为纳米陶瓷超耐涂层表面  
“R”后缀为电镀表面

Note: RNh means ceramic black coating surface  
R means chrome plated surface

左侧角 40°双关节咬骨钳  
Bone Rongeur left angled



- |                        |                        |                       |
|------------------------|------------------------|-----------------------|
| ZK973R/RNh 180x2, 直头   | ★ZK1060R/RNh 200x4, 直头 | ★ZK522R/RNh 220x6, 直头 |
| ★ZK974R/RNh 180x3, 直头  | ZK1061R/RNh 200x5, 直头  | ★ZK978R/RNh 240x2, 直头 |
| ★ZK975R/RNh 180x4, 直头  | ★ZK1062R/RNh 200x6, 直头 | ★ZK969R/RNh 240x3, 直头 |
| ZK976R/RNh 180x5, 直头   | ★ZK679R/RNh 220x2, 直头  | ZK970R/RNh 240x4, 直头  |
| ZK977R/RNh 180x6, 直头   | ★ZK519R/RNh 220x3, 直头  | ZK971R/RNh 240x5, 直头  |
| ZK1058R/RNh 200x2, 直头  | ★ZK520R/RNh 220x4, 直头  | ★ZK972R/RNh 240x6, 直头 |
| ★ZK1059R/RNh 200x3, 直头 | ★ZK521R/RNh 220x5, 直头  |                       |

双关节咬骨钳  
Bone Rongeur, big opening



- |                                     |                                    |
|-------------------------------------|------------------------------------|
| ★ZK805R 240x3, 大开档, 尖头 fine tip     | ★ZK815R 240x4x20°, 大开档             |
| ★ZK808R 240x2, 大开档                  | ★ZK818R 240x5x20°, 大开档             |
| ★ZK811R 240x3, 大开档                  | ZK807R 240x3x38°, 大开档, 尖头 fine tip |
| ★ZK814R 240x4, 大开档                  | ZK810R 240x2x38°, 大开档              |
| ★ZK817R 240x5, 大开档                  | ZK813R 240x3x38°, 大开档              |
| ★ZK806R 240x3x20°, 大开档, 尖头 fine tip | ZK816R 240x4x38°, 大开档              |
| ★ZK809R 240x2x20°, 大开档              | ZK819R 240x5x38°, 大开档              |
| ★ZK812R 240x3x20°, 大开档              |                                    |

右侧角 40°双关节咬骨钳  
Bone Rongeur right upwards angled



- ★ZK542R 240x2, 左上弯30°
- ★ZK546R 240x3, 左上弯30°
- ★ZK550R 240x4, 左上弯30°

双关节咬骨钳  
Bone Rongeur



- ★ZK435R 240x8, 直头 Straight
- ★ZK436R 240x8, 微弯 Slightly curved

单关节咬骨钳  
Bone Rongeur



- |                  |                  |
|------------------|------------------|
| ★ZK612R 180x2, 弯 | ★ZK784R 180x5, 弯 |
| ★ZK643R 180x3, 直 | ★ZK788R 180x8, 弯 |
| ★ZK782R 180x4, 弯 | Curved           |
| ★ZK611R 180x2, 直 | ★ZK783R 180x5, 直 |
| ★ZK642R 180x3, 直 | ★ZK787R 180x8, 直 |
| ★ZK781R 180x4, 直 | Straight         |



右侧角 40°双关节咬骨钳  
Bone Rongeur right upwards angled



- ★ZK544R 240x2, 右上弯30°
- ★ZK548R 240x3, 右上弯30°
- ★ZK552R 240x4, 右上弯30°

双关节咬骨钳  
Bone Rongeur, curved



- ★ZK570R 230x3x20°, 弯头
- ★ZK571R 220x4x20°, 弯头
- ★ZK534R 230x5x20°, 弯头
- ★ZK541R 230x6x20°, 弯头
- ★ZK507R 230x8x20°, 弯头

双关节棘突咬骨钳  
Bone Rongeur



- ★ZK566R 240x16, 直
- ★ZK564RN 260x16

咬骨钳  
Bone Rongeur



- ZQ4136RN/RNh 185, 直 Straight
- ZQ4137RN/RNh 185, 弯 Curved

单关节咬骨剪  
Bone Shear



- ★ZL864R 140,直 Straight
- ★ZL865R 140,弯 Curved
- ★ZK622R 180,直 Straight
- ★ZK623R 180,弯 Curved

双关节咬骨剪  
Bone Shear



- ★ZK615R 220,直 Straight
- ★ZK617R 240,直 Straight
- ★ZK620R 240,弯 Curved

双关节咬骨剪  
Bone Shear



- ★ZK765R 270,直 Straight
- ★ZK766R 270,弯 Curved

双关节棘突咬骨剪  
Bone Shear

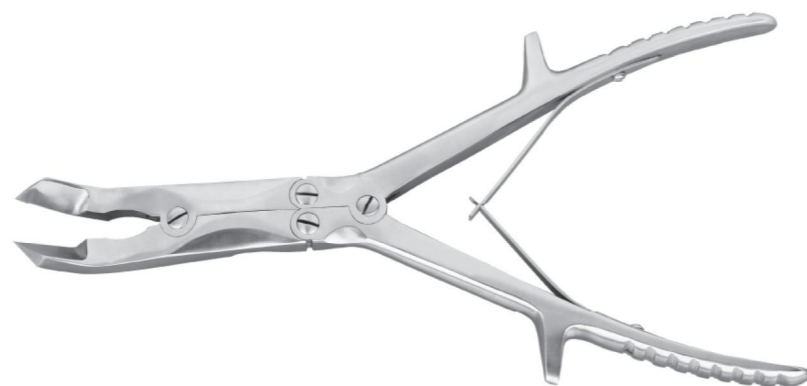

- ★ZK565RN 290x16

骨膜剥离器  
Periosteal Raspatory



- ★ZQ733R 150x3 直平刃
- ★ZQ734R 150x4 直平刃
- ★ZQ735R 150x5 直平刃
- ★ZQ736R 150x6 直平刃

- ★ZQ737R 150x3 弯圆刃
- ★ZQ738R 150x4 弯圆刃
- ★ZQ739R 150x5 弯圆刃
- ★ZQ740R 150x6 弯圆刃

骨膜剥离器  
Periosteal Raspatory



- ★ZQ741R 160x11 直平刃

- ★ZQ742R 160x11 弯平刃

骨膜剥离器  
Periosteal Raspatory



- ★ZQ633R 160x5, 微弯

- ★ZQ634R 160x5, 深弯

- ★ZQ635R 160x5, 微弯

- ★ZQ636R 160x5, 深弯

骨膜剥离器  
Periosteal Raspatory



- ★ ZQ983RN 180x6, 弯, 圆刃
- ★ ZQ767R 180x8, 弯, 圆刃
- ★ ZQ768R 180x10, 弯, 圆刃
- ★ ZQ984RN 180x12, 弯, 圆刃
- ★ ZQ985RN 180x15, 弯, 圆刃
- ★ ZQ986RN 180x20, 弯, 圆刃
- ★ ZQ997RN 180x18, 弯, 圆刃
- ★ ZQ987RN 220x6, 弯, 圆刃
- ★ ZQ988RN 220x8, 弯, 圆刃
- ★ ZQ989RN 220x10, 弯, 圆刃
- ★ ZQ990RN 220x12, 弯, 圆刃
- ★ ZQ991RN 220x15, 弯, 圆刃
- ★ ZQ992RN 220x20, 弯, 圆刃
- ★ ZQ998RN 220x18, 弯, 圆刃

骨膜剥离器  
Periosteal Raspatory



- ★ ZQ1251R 200x11, 弯

骨膜剥离器  
Periosteal Raspatory



- ZQ4121RN/RNh 165x7, 圆刃
- ZQ4122RN/RNh 180x15, 圆刃
- ZQ4123RN/RNh 180x20, 圆刃

骨膜剥离器  
Periosteal Raspatory Curved



- ★ ZQ686R 180x6, 弯, 平刃
- ★ ZQ687R 180x8, 弯, 平刃
- ★ ZQ694R 180x10, 弯, 平刃
- ★ ZQ769R 180x11, 弯, 平刃
- ★ ZQ688R 180x12, 弯, 平刃
- ★ ZQ770R 180x15, 弯, 平刃
- ★ ZQ689R 180x18, 弯, 平刃
- ★ ZQ698R 180x20, 弯, 平刃
- ZQ690R 180x22, 弯, 平刃
- ZQ691R 180x25, 弯, 平刃

骨膜剥离器  
Periosteal Raspatory Curved



- ★ ZQ692R 220x6, 弯, 平刃
- ★ ZQ693R 220x8, 弯, 平刃
- ★ ZQ844R 220x10, 弯, 平刃
- ★ ZQ695R 220x12, 弯, 平刃
- ★ ZQ845R 220x15, 弯, 平刃
- ★ ZQ697R 220x18, 弯, 平刃
- ★ ZQ846R 220x20, 弯, 平刃
- ZQ699R 220x22, 弯, 平刃
- ZQ700R 220x25, 弯, 平刃

神经剥离器  
Nerve Raspatory



- ★ ZQ755R/RN 240x3
- ★ ZQ756R/RN 240x5

神经剥离器  
Nerve Raspatory



- ZQ1320RN 240x5xφ1, 带钩 (钩深H:5mm)
- ★ ZQ757R/RN 240x5xφ1, 带钩 (钩深H:6mm)

神经剥离器  
Nerve Raspatory



- ★ ZQ1260R/RN 240x5xφ0.7, 带钩, 带刃 (钩深H:6mm) With cutting blade
- ZQ1319RN 240x3xφ0.7, 带钩, 带刃 (钩深H:6mm) With cutting blade

神经剥离器  
Nerve Raspatory With groove



- ZQ1317RN 240x3xφ0.8, 带钩带槽 (钩深H:6mm)
- ★ ZQ1258RN 240x5xφ0.8, 带钩带槽, 颈椎型 (钩深H:6mm)
- ★ ZQ1259RN 240x5xφ1, 带钩带槽, 腰椎型 (钩深H:6mm)

神经剥离器  
Nerve Raspatory

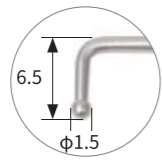

Q1257RN 240×5, 带钩  
Q1318RN 240×3, 带钩

神经剥离器



Q4125RN/RNh 175×5×3.5, 双头

骨膜剥离器  
Periosteal Raspatory



Q4124RN/RNh 160×11×4.5, 双头

显微钩



Q3611RN 280×10×φ1

骨膜剥离器  
Periosteal Raspatory



★ Q3622RN 195×4, 双头

骨膜剥离器  
Periosteal Raspatory



★ Q652RN 240×3×5, 微弯, 双头  
Slightly curved

Q653RN 240×3×5, 深弯, 双头  
Largely curved

双头骨膜剥离器  
Periosteal Raspatory



★ ZK358R 190, 2#, 滚花柄, 90°/弯

双头骨膜剥离器  
Periosteal Raspatory



★ ZK359R 200, 1#, 滚花柄, 弯/弯

双头骨膜剥离器  
Periosteal Raspatory



★ ZQ771R 270x12x15

双头骨膜剥离器  
Periosteal Raspatory



★ ZQ751R 200x4, 弯/弯, 扁柄

寰弓剥离子  
Atlas Bow Raspatory



★ ZQ2049R 270x4x5, 微弯

寰弓剥离子  
Atlas Bow Raspatory



★ ZQ2050R 270x3, 深弯

双头骨膜剥离器  
Periosteal Raspatory



★ZQ753R 200x5.6/5.2

双头骨膜剥离器  
Periosteal Raspatory



★ZQ772R 200x5, 侧弯/侧弯, 扁柄

骨膜剥离器  
Periosteal Raspatory



ZQ3616RN 270×14, 锐口  
Sharp



★ ZQ3618RN 270×14, 钝口  
Blunt

骨膜剥离器  
Periosteal Raspatory



★ ZQ3619RN 330×8

骨膜剥离器  
Periosteal Raspatory



ZQ3620RN 280×13, 锐口  
Sharp



★ ZQ3621RN 280×13, 钝口  
Blunt

骨膜剥离器 (胶木柄)  
Periosteal Raspatory



★ZQ543R 240x8 直平刃

★ZQ544R 240x10 直平刃

★ZQ545R 240x14 直平刃



★ZQ546R 240x8 弯平刃

★ZQ547R 240x10 弯平刃

★ZQ548R 240x14 弯平刃

骨膜剥离器 (胶木柄)  
Periosteal Raspatory



ZQ549R 240x8 弯圆刃

ZQ550R 240x10 弯圆刃

ZQ551R 240x14 弯圆刃

骨膜剥离器  
Periosteal Raspatory



ZQ760R 280x10x90°, 角弯

骨膜剥离器 (滚花柄)  
Periosteal Raspatory



★ ZQ552R 280x16 直圆刃, 重切削型

★ ZQ553R 280x20 直圆刃, 重切削型

★ ZQ554R 280x24 直圆刃, 重切削型



★ ZQ555R 280x16 弯圆刃, 重切削型

★ ZQ556R 280x20 弯圆刃, 重切削型

★ ZQ557R 280x24 弯圆刃, 重切削型

骨膜剥离器 (胶木柄)  
Periosteal Raspatory



- ★ZQ558R 280x12 平直刃
- ★ZQ559R 280x16 平直刃
- ★ZQ560R 280x20 平直刃

骨膜剥离器 (胶木柄)  
Periosteal Raspatory



- ★ZQ561R 280x12 圆弯刃
- ★ZQ562R 280x16 圆弯刃
- ★ZQ563R 280x20 圆弯刃

骨膜剥离器 (胶木柄)  
Periosteal Raspatory



- ZQ564R 330x8 圆弯刃
- ZQ565R 330x12 圆弯刃
- ZQ566R 330x16 圆弯刃

骨膜分离器 (胶木柄)  
Periosteal Raspatory



- ZQ795R 300xΦ15, 锐 sharp
- ZQ796R 300xΦ15, 钝 blunt
- ZQ797R 300xΦ20, 锐 sharp
- ZQ798R 300xΦ20, 钝 blunt

骨膜分离器 (胶木柄)  
Periosteal Raspatory



- ZQ787RB 300xΦ20, 锐弯 sharp
- ★ZQ788RB 300xΦ20, 钝弯 blunt

骨膜分离器 (铝合金柄)  
Periosteal Raspatory Aluminum handle



- ZQ781RN 300xΦ15, 锐 sharp
- ZQ782RN 300xΦ15, 钝 blunt
- ZQ783RN 300xΦ20, 锐 sharp
- ZQ784RN 300xΦ20, 钝 blunt

骨凿 (方柄)  
Chisel



- | Double-bevelled |                | Single-bevelled |                |
|-----------------|----------------|-----------------|----------------|
| ★ZQ320R         | 140x2, 直, 双斜刃  | ZQ325R          | 140x2, 直, 单斜刃  |
| ★ZQ321R         | 140x4, 直, 双斜刃  | ZQ326R          | 140x4, 直, 单斜刃  |
| ★ZQ322R         | 140x6, 直, 双斜刃  | ZQ327R          | 140x6, 直, 单斜刃  |
| ★ZQ323R         | 140x8, 直, 双斜刃  | ZQ328R          | 140x8, 直, 单斜刃  |
| ★ZQ324R         | 140x10, 直, 双斜刃 | ZQ329R          | 140x10, 直, 单斜刃 |

骨凿 (扁柄)  
Osteotome



- |        |               |        |               |        |                |
|--------|---------------|--------|---------------|--------|----------------|
| ZQ330R | 140x2, 直, 双斜刃 | ZQ332R | 140x6, 直, 双斜刃 | ZQ334R | 140x10, 直, 双斜刃 |
| ZQ331R | 140x4, 直, 双斜刃 | ZQ333R | 140x8, 直, 双斜刃 |        |                |

骨凿 (方柄)  
Chisel



- | Double-bevelled |                | Single-bevelled |                |
|-----------------|----------------|-----------------|----------------|
| ★ZQ335R         | 170x4, 直, 双斜刃  | ZQ341R          | 170x4, 直, 单斜刃  |
| ★ZQ336R         | 170x6, 直, 双斜刃  | ZQ342R          | 170x6, 直, 单斜刃  |
| ★ZQ337R         | 170x8, 直, 双斜刃  | ★ZQ343R         | 170x8, 直, 单斜刃  |
| ★ZQ338R         | 170x10, 直, 双斜刃 | ★ZQ344R         | 170x10, 直, 单斜刃 |
| ★ZQ339R         | 170x12, 直, 双斜刃 | ZQ345R          | 170x12, 直, 单斜刃 |
| ★ZQ340R         | 170x14, 直, 双斜刃 | ★ZQ346R         | 170x14, 直, 单斜刃 |

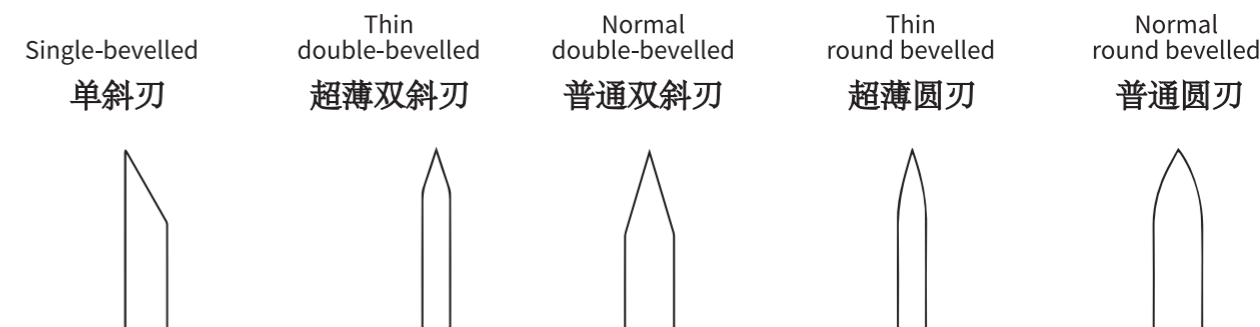

圆骨凿 (方柄)  
Gouge



- ★ZQ347R** 170x4, 直, 单斜刃
- ★ZQ349R** 170x8, 直, 单斜刃
- ★ZQ351R** 170x12, 直, 单斜刃
- ★ZQ348R** 170x6, 直, 单斜刃
- ★ZQ350R** 170x10, 直, 单斜刃
- ★ZQ352R** 170x14, 直, 单斜刃

截骨刀 (长方柄)  
Osteotome  
double bevelled



- ★ZQ420R** 230x6, 直, 双斜刃
- ★ZQ423R** 230x16, 直, 双斜刃
- ZQ426R** 230x30, 直, 双斜刃
- ★ZQ421R** 230x9, 直, 双斜刃
- ZQ424R** 230x20, 直, 双斜刃
- ZQ427R** 230x36, 直, 双斜刃
- ★ZQ422R** 230x12, 直, 双斜刃
- ZQ425R** 230x25, 直, 双斜刃

截骨刀 (长方柄)  
Osteotome  
double bevelled  
curved

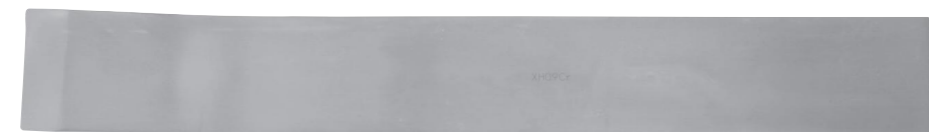

- ZQ428R** 230x6, 弯, 双斜刃
- ZQ431R** 230x16, 弯, 双斜刃
- ZQ434R** 230x30, 弯, 双斜刃
- ZQ429R** 230x9, 弯, 双斜刃
- ZQ432R** 230x20, 弯, 双斜刃
- ZQ435R** 230x36, 弯, 双斜刃
- ZQ430R** 230x12, 弯, 双斜刃
- ZQ433R** 230x25, 弯, 双斜刃

截骨刀  
Osteotome  
double bevelled



- ★ ZQ3401RN** 240x10
- ZQ3403RN** 240x20
- ★ ZQ3402RN** 240x15
- ZQ3404RN** 240x25

骨刀  
Osteotome  
double bevelled



- ★ ZK090R** 170x3, 滚花柄
- ★ ZK095R** 170x10, 滚花柄
- ZK117R** 170x12, 直形, 圆柄
- ★ ZK093R** 170x5, 滚花柄
- ZK114R** 125x4, 直形, 圆柄
- ZK118R** 170x15, 直形, 圆柄
- ★ ZK094R** 170x7, 滚花柄
- ZK115R** 125x6, 直形, 圆柄
- ZK119R** 170x20, 直形, 圆柄
- ZK116R** 125x8, 直形, 圆柄

骨凿  
Gouge



- ★ZK091R** 170x3, 滚花柄, 半圆型
- ★ZK092R** 170x5, 滚花柄, 半圆型

薄型骨刀  
Thin finger osteotome  
double bevelled



- ★ZQ790R** 180x2(手指用), 直, 双斜刃
- ★ZQ793R** 180x5(手指用), 直, 双斜刃
- ★ZQ791R** 180x3(手指用), 直, 双斜刃
- ★ZQ794R** 180x6(手指用), 直, 双斜刃
- ★ZQ792R** 180x4(手指用), 直, 双斜刃

薄型骨刀  
Thin cervical osteotome  
double bevelled



- ★ZQ775R** 200x3(颈椎用), 直, 双斜刃
- ★ZQ777R** 200x5(颈椎用), 直, 双斜刃
- ★ZQ779R** 200x8(颈椎用), 直, 双斜刃
- ★ZQ776R** 200x4(颈椎用), 直, 双斜刃
- ★ZQ778R** 200x6(颈椎用), 直, 双斜刃
- ZQ780R** 200x10(颈椎用), 直, 双斜刃

薄型骨刀  
Thin cervical osteotome  
double bevelled double bevelled



- ZQ775RN** 200x3(颈椎用), 直, 双斜刃
- ZQ777RN** 200x5(颈椎用), 直, 双斜刃
- ZQ776RN** 200x4(颈椎用), 直, 双斜刃
- ZQ779RN** 200x8(颈椎用), 直, 双斜刃

薄型骨刀  
Thin osteotome  
double bevelled



- ★ZQ1216RN** 300x10

颈椎骨刀 (滚花柄)  
Cervical osteotome double bevelled



- ★ZQ436R** 220x6, 直, 双斜刃
- ★ZQ438R** 220x12, 直, 双斜刃
- ★ZQ437R** 220x9, 直, 双斜刃

骨刀  
Chisel  
Double blades



ZQ392R 230x8, 直, 双刃

ZQ393R 260x8, 双刃

圆骨凿 (滚花柄)  
Gouge



★ZQ381R 220x4, 直, 单斜刃

★ZQ385R 220x8, 直, 单斜刃

★ZQ389R 220x12, 直, 单斜刃

★ZQ383R 220x6, 直, 单斜刃

★ZQ387R 220x10, 直, 单斜刃

ZQ395R 180x4, 直, 圆刃

圆骨凿 (滚花柄)  
Gouge



ZQ382R 220x4, 弯, 单斜刃

ZQ386R 220x8, 弯, 单斜刃

ZQ390R 220x12, 弯, 单斜刃

ZQ384R 220x6, 弯, 单斜刃

ZQ388R 220x10, 弯, 单斜刃

弧形骨凿 (滚花柄)  
Chisel



★ZQ354R 220 1#, 弯, 单斜刃



ZQ355R 220 2#, 弯, 单斜刃



★ZQ356R 220 3#, 弯, 单斜刃

骨凿 (滚花柄)  
Osteotome  
double bevelled



★ZQ396R 230x4, 直, 双斜刃

★ZQ358R 230x8, 直, 双斜刃

★ZQ659R 230x12, 直, 双斜刃

★ZQ397R 230x6, 直, 双斜刃

★ZQ359R 230x10, 直, 双斜刃

骨凿 (滚花柄)  
Chisel



★ZQ357R 280x6, 直, 单斜刃

★ZQ363R 280x25°x10, 弯, 双斜刃

ZQ365R 280x25°x10, 弯, 圆刃

★ZQ625R 280x8, 直, 单斜刃

ZQ364R 280x25°x15, 弯, 双斜刃

ZQ366R 280x25°x15, 弯, 圆刃

ZQ626R 280x10, 直, 单斜刃  
Chisel, single-bevelled

Osteotome, double bevelled

Gouge



ZQ367R 280x8, 梯形, 单斜刃  
Chisel, single-bevelled

ZQ368R 280x7, 直角, 单斜刃  
Chisel, single-bevelled

圆骨凿 (滚花柄)  
Gouge



ZQ369R 340x10, 直, 圆刃

ZQ371R 340x10, 弯, 圆刃

ZQ370R 340x15, 直, 圆刃

ZQ372R 340x15, 弯, 圆刃

半圆脱臼骨凿  
Dislocation Chisel



ZQ2028R 215x22.5, 缩口式



ZQ2029R 215x22.5, 外翻式

截骨刀 (六角柄)  
Osteotome, round  
double bevelled



- |                             |                             |                             |
|-----------------------------|-----------------------------|-----------------------------|
| ★ ZQ401R 230x8, 直, 平刃, 六角柄  | ★ ZQ404R 230x18, 直, 平刃, 六角柄 | ★ ZQ411R 230x8, 弯, 平刃, 六角柄  |
| ★ ZQ402R 230x10, 直, 平刃, 六角柄 | ★ ZQ400R 230x20, 直, 平刃, 六角柄 | ★ ZQ412R 230x12, 弯, 平刃, 六角柄 |
| ★ ZQ403R 230x12, 直, 平刃, 六角柄 | ★ ZQ405R 230x24, 直, 平刃, 六角柄 | ★ ZQ413R 230x18, 弯, 平刃, 六角柄 |
| ★ ZQ398R 230x15, 直, 平刃, 六角柄 | ★ ZQ406R 230x30, 直, 平刃, 六角柄 | ★ ZQ414R 230x24, 弯, 平刃, 六角柄 |
| ★ ZQ399R 230x16, 直, 平刃, 六角柄 |                             | ★ ZQ415R 230x30, 弯, 平刃, 六角柄 |



- |                             |                             |
|-----------------------------|-----------------------------|
| ★ ZQ407R 230x10, 直, 圆刃, 六角柄 | ★ ZQ416R 230x10, 弯, 圆刃, 六角柄 |
| ZQ408R 230x15, 直, 圆刃, 六角柄   | ZQ417R 230x15, 弯, 圆刃, 六角柄   |
| ZQ409R 230x20, 直, 圆刃, 六角柄   | ZQ418R 230x20, 弯, 圆刃, 六角柄   |
| ZQ410R 230x25, 直, 圆刃, 六角柄   | ZQ419R 230x25, 弯, 圆刃, 六角柄   |

骨凿 (六方柄)  
Osteotome, round  
double bevelled



- |                             |                             |                             |
|-----------------------------|-----------------------------|-----------------------------|
| ★ ZQ319R 240x6, 直, 平刃, 六方柄  | ★ ZQ375R 240x12, 直, 平刃, 六方柄 | ★ ZQ378R 240x20, 直, 平刃, 六方柄 |
| ★ ZQ373R 240x8, 直, 平刃, 六方柄  | ★ ZQ376R 240x15, 直, 平刃, 六方柄 | ★ ZQ379R 240x25, 直, 平刃, 六方柄 |
| ★ ZQ374R 240x10, 直, 平刃, 六方柄 | ★ ZQ377R 240x18, 直, 平刃, 六方柄 | ★ ZQ380R 240x30, 直, 平刃, 六方柄 |

薄型限位骨刀  
Chisel, thin  
single bevelled



- |                        |                        |                        |
|------------------------|------------------------|------------------------|
| ZQ800R 220x6x6, 直, 单斜刃 | ZQ801R 220x7x6, 直, 单斜刃 | ZQ802R 220x8x7, 直, 单斜刃 |
|------------------------|------------------------|------------------------|

薄型限位骨刀  
Osteotome  
double bevelled, thin

- ZQ353R 90, 直, 双斜刃



髓核凿 (骨刀)  
Chisel



- |                     |                                      |
|---------------------|--------------------------------------|
| ★ ZQ705RN/RB 235xΦ6 | ZQ708RN/RB 6.5x5.2, 椭圆 Oval opening  |
| ZQ706RN/RB 235xΦ8   | ZQ709RN/RB 8.5x7.2, 椭圆 Oval opening  |
| ZQ707RN/RB 235xΦ10  | ZQ710RN/RB 10.5x9.2, 椭圆 Oval opening |

半月板刀  
Meniscotome



- |                    |                                |                                 |
|--------------------|--------------------------------|---------------------------------|
| ★ ZQ248R 170x6, 直型 | ★ ZQ246R 170x6, 左弯 Left curved | ★ ZQ247R 170x6, 右弯 Right curved |
|--------------------|--------------------------------|---------------------------------|

鹅眉型骨凿 (胶木柄)  
Gouge



- |                            |                          |
|----------------------------|--------------------------|
| ★ ZQ820R 240x6, 直头平口, 单斜刃  | ZQ828R 280x6, 直头平口, 单斜刃  |
| ★ ZQ821R 240x8, 直头平口, 单斜刃  | ZQ829R 280x8, 直头平口, 单斜刃  |
| ★ ZQ822R 240x10, 直头平口, 单斜刃 | ZQ830R 280x10, 直头平口, 单斜刃 |
| ZQ823R 240x12, 直头平口, 单斜刃   | ZQ831R 280x12, 直头平口, 单斜刃 |
| ZQ824R 260x6, 直头平口, 单斜刃    | ZQ894R 300x6, 直头平口, 单斜刃  |
| ★ ZQ825R 260x8, 直头平口, 单斜刃  | ZQ895R 300x8, 直头平口, 单斜刃  |
| ★ ZQ826R 260x10, 直头平口, 单斜刃 | ZQ896R 300x10, 直头平口, 单斜刃 |
| ZQ827R 260x12, 直头平口, 单斜刃   | ZQ897R 300x12, 直头平口, 单斜刃 |

骨刀 (非圆座胶木柄)  
Osteotome  
thin round  
double bevelled



- |                        |                        |                        |
|------------------------|------------------------|------------------------|
| ★ZQ1162R 260x8, 超薄双斜刃  | ★ZQ1168R 260x25, 超薄双斜刃 | ★ZQ1174R 300x18, 超薄双斜刃 |
| ★ZQ1163R 260x10, 超薄双斜刃 | ★ZQ1169R 260x30, 超薄双斜刃 | ★ZQ1175R 300x20, 超薄双斜刃 |
| ★ZQ1164R 260x12, 超薄双斜刃 | ★ZQ1170R 300x8, 超薄双斜刃  | ★ZQ1176R 300x25, 超薄双斜刃 |
| ★ZQ1165R 260x15, 超薄双斜刃 | ★ZQ1171R 300x10, 超薄双斜刃 | ZQ1177R 300x30, 超薄双斜刃  |
| ★ZQ1166R 260x18, 超薄双斜刃 | ★ZQ1172R 300x12, 超薄双斜刃 |                        |
| ★ZQ1167R 260x20, 超薄双斜刃 | ★ZQ1173R 300x15, 超薄双斜刃 |                        |



- ZQ1180R 260x8x30°, 前弯, 平口, 超薄刃  
ZQ1181R 260x10x30°, 前弯, 平口, 超薄刃  
ZQ1182R 260x12x30°, 前弯, 平口, 超薄刃  
ZQ1183R 260x15x30°, 前弯, 平口, 超薄刃



- ★ZQ1193R 260x6, 短弧, 圆口, 超薄刃  
ZQ1194R 260x9, 短弧, 圆口, 超薄刃  
ZQ1195R 260x12, 短弧, 圆口, 超薄刃



- ZQ1203R 260x9x15°, 后弯, 圆口, 超薄刃  
ZQ1204R 260x12x15°, 后弯, 圆口, 超薄刃  
ZQ1205R 260x15x15°, 后弯, 圆口, 超薄刃



- ZQ1215R 300x8, 短弧, 超薄斜刃  
★ZQ1226R 300x10, 短弧, 超薄斜刃  
ZQ1217R 300x12, 短弧, 超薄斜刃  
★ZQ1218R 300x15, 短弧, 超薄斜刃  
ZQ1219R 300x18, 短弧, 超薄斜刃  
ZQ1220R 300x20, 短弧, 超薄斜刃  
ZQ1221R 300x25, 短弧, 超薄斜刃  
ZQ1222R 300x30, 短弧, 超薄斜刃



- ZQ1223R 260x6, 枪形, 超薄刃  
ZQ1224R 260x8, 枪形, 超薄刃  
ZQ1225R 260x10, 枪形, 超薄刃



- ZQ1186R 260x6, 长弧, 圆口, 超薄刃  
ZQ1187R 260x8, 长弧, 圆口, 超薄刃  
ZQ1188R 260x10, 长弧, 圆口, 超薄刃  
ZQ1189R 260x12, 长弧, 圆口, 超薄刃  
ZQ1190R 260x15, 长弧, 圆口, 超薄刃



- ZQ1198R 260x9x15°, 前弯, 圆口, 超薄刃  
ZQ1199R 260x12x15°, 前弯, 圆口, 超薄刃  
ZQ1200R 260x15x15°, 前弯, 圆口, 超薄刃



- ZQ1208R 260x6, 平直口, 超薄刃  
ZQ1209R 260x8, 平直口, 超薄刃  
ZQ1210R 260x10, 平直口, 超薄刃  
ZQ1211R 260x12, 平直口, 超薄刃  
ZQ1212R 260x15, 平直口, 超薄刃



- ZQ1228R 300x8, 梯形, 超薄斜刃  
ZQ1229R 300x10, 梯形, 超薄斜刃  
ZQ1230R 300x12, 梯形, 超薄斜刃  
ZQ1231R 300x15, 梯形, 超薄斜刃



- ZQ1236R 260x9, 直圆头, 超薄刃  
ZQ1237R 260x12, 直圆头, 超薄刃  
ZQ1238R 260x15, 直圆头, 超薄刃

骨刀  
Osteotome

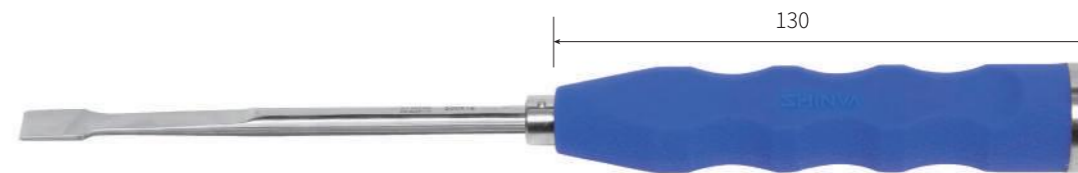

- |                       |                       |                       |                       |
|-----------------------|-----------------------|-----------------------|-----------------------|
| ★ZQ1597R 270x6, 超薄圆刃  | ZQ1595R 270x6, 普通圆刃   | ★ZQ1599R 300x6, 超薄圆刃  | ZQ1596R 300x6, 普通圆刃   |
| ★ZQ1632R 270x8, 超薄圆刃  | ★ZQ1640R 270x8, 普通圆刃  | ★ZQ1600R 300x8, 超薄圆刃  | ★ZQ1608R 300x8, 普通圆刃  |
| ★ZQ1633R 270x10, 超薄圆刃 | ★ZQ1641R 270x10, 普通圆刃 | ★ZQ1601R 300x10, 超薄圆刃 | ★ZQ1609R 300x10, 普通圆刃 |
| ★ZQ1634R 270x12, 超薄圆刃 | ★ZQ1642R 270x12, 普通圆刃 | ★ZQ1602R 300x12, 超薄圆刃 | ★ZQ1610R 300x12, 普通圆刃 |
| ★ZQ1635R 270x15, 超薄圆刃 | ★ZQ1643R 270x15, 普通圆刃 | ★ZQ1603R 300x15, 超薄圆刃 | ★ZQ1611R 300x15, 普通圆刃 |
| ★ZQ1636R 270x18, 超薄圆刃 | ZQ1644R 270x18, 普通圆刃  | ★ZQ1604R 300x18, 超薄圆刃 | ★ZQ1612R 300x18, 普通圆刃 |
| ★ZQ1637R 270x20, 超薄圆刃 | ZQ1645R 270x20, 普通圆刃  | ★ZQ1605R 300x20, 超薄圆刃 | ZQ1613R 300x20, 普通圆刃  |
| ★ZQ1638R 270x25, 超薄圆刃 | ZQ1646R 270x25, 普通圆刃  | ★ZQ1606R 300x25, 超薄圆刃 | ZQ1614R 300x25, 普通圆刃  |
| ★ZQ1639R 270x30, 超薄圆刃 | ZQ1647R 270x30, 普通圆刃  | ZQ1607R 300x30, 超薄圆刃  | ZQ1615R 300x30, 普通圆刃  |
- Thin round double bevelled      Normal round double bevelled      Thin round double bevelled      Normal round double bevelled



- ★ZQ3601RN 280x8, 直  
★ZQ3602RN 280x10, 直  
★ZQ3623RN 280x12, 直  
★ZQ3603RN 280x15, 直  
★ZQ3604RN 280x20, 直



- ★ZQ3624RN 280x8, 弯  
★ZQ3605RN 280x10, 弯  
★ZQ3625RN 280x12, 弯  
★ZQ3606RN 280x15, 弯  
ZQ3607RN 280x20, 弯



- ZQ1648R 300x8, 梯形, 超薄圆刃  
ZQ1649R 300x10, 梯形, 超薄圆刃  
ZQ1650R 300x12, 梯形, 超薄圆刃  
ZQ1651R 300x15, 梯形, 超薄圆刃  
ZQ1652R 300x18, 梯形, 超薄圆刃  
Thin round double bevelled



- ★ZQ1678R 300x8, 短弧, 超薄圆刃  
ZQ1679R 300x10, 短弧, 超薄圆刃  
ZQ1680R 300x12, 短弧, 超薄圆刃  
ZQ1681R 300x15, 短弧, 超薄圆刃  
ZQ1682R 300x18, 短弧, 超薄圆刃  
ZQ1683R 300x20, 短弧, 超薄圆刃  
ZQ1684R 300x25, 短弧, 超薄圆刃  
ZQ1685R 300x30, 短弧, 超薄圆刃  
Thin round double bevelled



- ZQ1818R 270x6, 长弧, 圆口, 超薄刃  
ZQ1819R 270x8, 长弧, 圆口, 超薄刃  
ZQ1820R 270x10, 长弧, 圆口, 超薄刃  
ZQ1821R 270x12, 长弧, 圆口, 超薄刃  
ZQ1822R 270x15, 长弧, 圆口, 超薄刃



- ZQ1838R 270x6, 平直口, 超薄刃  
ZQ1839R 270x8, 平直口, 超薄刃  
ZQ1840R 270x10, 平直口, 超薄刃  
ZQ1841R 270x12, 平直口, 超薄刃  
ZQ1842R 270x15, 平直口, 超薄刃



- ★ZQ1658R 270x6, 直圆口, 超薄刃  
★ZQ1659R 270x8, 直圆口, 超薄刃  
ZQ1660R 270x10, 直圆口, 超薄刃  
ZQ1661R 270x12, 直圆口, 超薄刃  
ZQ1662R 270x15, 直圆口, 超薄刃



- ZQ1748R 270x9x15°, 超薄刃, 前弯  
ZQ1749R 270x12x15°, 超薄刃, 前弯  
ZQ1750R 270x15x15°, 超薄刃, 前弯



- ZQ1760R 270x9x15°, 超薄刃, 后弯  
ZQ1761R 270x12x15°, 超薄刃, 后弯  
ZQ1762R 270x15x15°, 超薄刃, 后弯



- ZQ1772R 270x9x30°, 超薄刃, 前弯  
ZQ1773R 270x12x30°, 超薄刃, 前弯  
ZQ1774R 270x15x30°, 超薄刃, 前弯



- ZQ1784R 270x6, 梯形, 圆口, 超薄刃  
ZQ1785R 270x8, 梯形, 圆口, 超薄刃  
ZQ1786R 270x10, 梯形, 圆口, 超薄刃



- ZQ1806R 270x6, 短弧, 圆口, 超薄刃  
ZQ1807R 270x9, 短弧, 圆口, 超薄刃  
ZQ1808R 270x12, 短弧, 圆口, 超薄刃



骨刀  
Gouge



ZQ3804RN 310×7.5



ZQ3805RN 310×12.5



★ ZQ3806RN 310×8.5



ZQ3807RN 310×10



ZQ3817RN 310×20



ZQ3818RN 310×25



ZQ3819RN 310×15



ZQ3820RN 320



ZQ3821RN 335



骨刀  
Chisel



★ ZQ3628RN 320×10, 直, 双肩  
★ ZQ3629RN 320×15, 直, 双肩



★ ZQ3627RN 320×10, 弯, 双肩  
★ ZQ3608RN 320×15, 弯, 双肩  
★ ZQ3609RN 320×20, 弯, 双肩



骨刀  
Osteotome  
PPSU handle

- ★ JQ2708RNh 180×4, 直, 超薄刃
- ★ JQ2709RNh 180×6, 直, 超薄刃
- ★ JQ2710RNh 180×8, 直, 超薄刃
- ★ JQ2711RNh 180×10, 直, 超薄刃
- ★ JQ2712RNh 180×12, 直, 超薄刃

Thin round double bevelled

骨刀  
Osteotome  
PPSU handle



- ★ ZQ4151RN/RNh 220×4, 直, 超薄刃, PPSU柄
  - ★ ZQ4152RN/RNh 220×8, 直, 超薄刃, PPSU柄
  - ★ ZQ4112RN/RNh 220×10, 直, 超薄刃, PPSU柄
  - ★ ZQ4113RN/RNh 220×12, 直, 超薄刃, PPSU柄
  - ★ ZQ4114RN/RNh 220×15, 直, 超薄刃, PPSU柄
  - ZQ4115RN/RNh 220×20, 直, 超薄刃, PPSU柄
  - ZQ4116RN/RNh 220×25, 直, 超薄刃, PPSU柄
- Thin round double bevelled

软骨铲  
Gouge, silicone handle



- ZQ4118RN/RNh 220×13, 内刃, PPSU柄 Inside blade
- ZQ4119RN/RNh 220×8.5, 外刃, PPSU柄 Outside blade

骨刀(硅胶柄)  
Gouge



Thin round double bevelled

- ★ JQ1597RNh 270×6, 直, 超薄刃
- ★ JQ1632RNh 270×8, 直, 超薄刃
- ★ JQ1633RNh 270×10, 直, 超薄刃
- ★ JQ1634RNh 270×12, 直, 超薄刃
- ★ JQ1635RNh 270×15, 直, 超薄刃
- JQ1636RNh 270×18, 直, 超薄刃
- JQ1637RNh 270×20, 直, 超薄刃
- ★ JQ1598RNh 300×6, 直, 超薄刃
- ★ JQ1600RNh 300×8, 直, 超薄刃
- ★ JQ1601RNh 300×10, 直, 超薄刃
- ★ JQ1602RNh 300×12, 直, 超薄刃
- ★ JQ1603RNh 300×15, 直, 超薄刃
- JQ1604RNh 300×18, 直, 超薄刃
- JQ1605RNh 300×20, 直, 超薄刃



Thin blade

- JQ1838RNh 270×6, 直, 平口, 超薄刃
- JQ1839RNh 270×8, 直, 平口, 超薄刃
- JQ1840RNh 270×10, 直, 平口, 超薄刃

骨凿 (滚花柄)  
Osteotome  
double bevelled



- JQ381RB 220x4, 直, 单斜刃, 滚花柄
- ★ JQ383RB 220x6, 直, 单斜刃, 滚花柄
- JQ385RB 220x8, 直, 单斜刃, 滚花柄
- JQ387RB 220x10, 直, 单斜刃, 滚花柄
- JQ389RB 220x12, 直, 单斜刃, 滚花柄

- ★ JQ436RB 220x6, 直, 双斜刃, 滚花柄, 颈椎用
- ★ JQ437RB 220x9, 直, 双斜刃, 滚花柄, 颈椎用
- ★ JQ438RB 220x12, 直, 双斜刃, 滚花柄, 颈椎用



- JQ775RB 200x3 (颈椎用), 直
- JQ776RB 200x4 (颈椎用), 直
- JQ777RB 200x5 (颈椎用), 直
- ★ JQ778RB 200x6 (颈椎用), 直
- ★ JQ779RB 200x8 (颈椎用), 直
- JQ780RB 200x10 (颈椎用), 直

- JQ790RB 180x2 (手指用), 直
- JQ791RB 180x3 (手指用), 直
- ★ JQ792RB 180x4 (手指用), 直
- JQ793RB 180x5 (手指用), 直
- JQ794RB 180x6 (手指用), 直

骨刀 (滚花柄)  
Osteotome, thin round double bevelled



- JQ1695RN 300x2, 滚花柄
- JQ1696RN 300x4, 滚花柄
- JQ1697RN 300x6, 滚花柄
- JQ1698RN 300x8, 滚花柄
- JQ1875RN 250x2, 滚花柄
- JQ1876RN 250x4, 滚花柄
- JQ1877RN 250x6, 滚花柄
- JQ1878RN 250x8, 滚花柄

截骨刀 (六角柄)  
Osteotome, thin round double bevelled



- ★ JQ401RN 230x8, 直, 超薄圆刃, 六角柄
- ★ JQ402RN 230x10, 直, 超薄圆刃, 六角柄
- ★ JQ403RN 230x12, 直, 超薄圆刃, 六角柄
- ★ JQ398RN 230x15, 直, 超薄圆刃, 六角柄

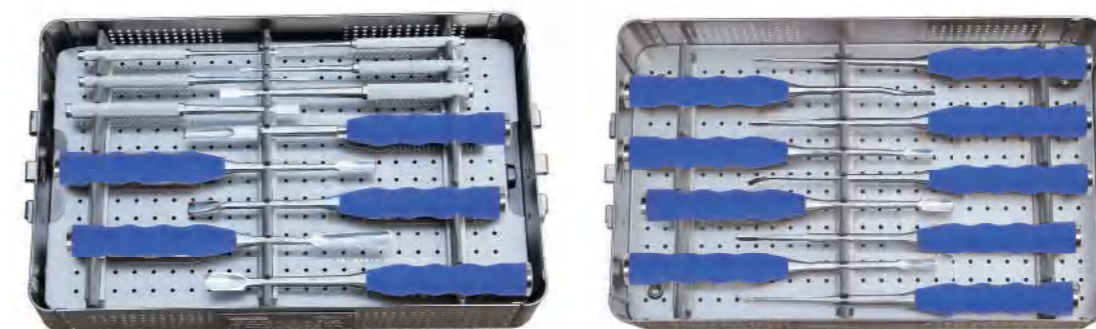

BGD- II 型骨刀专用手术器械包 (ZK303)  
BGD- II thin osteotome instruments set

序号	编码	名称	规格	单位	数量
1	ZQ776R	薄型骨刀	200×4 (颈椎用)	把	1
2	ZQ778R	薄型骨刀	200×6 (颈椎用)	把	1
3	ZQ779R	薄型骨刀	200×8 (颈椎用)	把	1
4	ZQ790R	薄型骨刀	180×2 (手指用)	把	1
5	ZQ395R	骨刀	180×4, 直圆刃	把	1
6	ZQ1600R	平骨刀	300×8, 超薄圆刃	把	1
7	ZQ1601R	平骨刀	300×10, 超薄圆刃	把	1
8	ZQ1602R	平骨刀	300×12, 超薄圆刃	把	1
9	ZQ1679R	平骨刀	300×10, 短弧, 超薄圆刃	把	1
10	ZQ1681R	平骨刀	300×15, 短弧, 超薄圆刃	把	1
11	ZQ1807R	圆骨刀	270×9, 短弧, 圆口, 超薄刃	把	1
12	ZQ1821R	圆骨刀	270×12, 长弧, 圆口, 超薄刃	把	1
13	ZQ1661R	圆骨刀	270×12, 直圆口, 超薄刃	把	1
14	ZQ1750R	圆骨刀	270×15×15°, 圆口, 超薄刃, 前弯	把	1
15	ZQ1761R	圆骨刀	270×12×15°, 圆口, 超薄刃, 后弯	把	1
16	ZQ1840R	圆骨刀	270×10, 直平口, 超薄刃	把	1
17	ZQ1785R	圆骨刀	270×8, 梯形, 圆口, 超薄刃	把	1
18	ZQ1786R	圆骨刀	270×10, 梯形, 圆口, 超薄刃	把	1
19	ZQ437R	颈椎骨刀	220×9, 直平刃	把	1
20	ZQ1886R	鹅眉型骨凿 (扁胶木柄)	260×10, 直头平口	把	1



BGD- I 型骨刀专用手术器械包 (ZK302)  
BGD- I thin osteotome instruments set

序号	编码	名称	规格	单位	数量
1	ZQ776R	薄型骨刀	200×4 (颈椎用)	把	1
2	ZQ778R	薄型骨刀	200×6 (颈椎用)	把	1
3	ZQ779R	薄型骨刀	200×8 (颈椎用)	把	1
4	ZQ790R	薄型骨刀	180×2 (手指用)	把	1
5	ZQ395R	骨刀	180×4, 直圆刃	把	1
6	ZQ1170R	平骨刀 (胶木柄)	300×8, 超薄斜刃	把	1
7	ZQ1171R	平骨刀 (胶木柄)	300×10, 超薄斜刃	把	1
8	ZQ1172R	平骨刀 (胶木柄)	300×12, 超薄斜刃	把	1
9	ZQ1226R	平骨刀 (胶木柄)	300×10, 短弧, 超薄斜刃	把	1
10	ZQ1218R	平骨刀 (胶木柄)	300×15, 短弧, 超薄斜刃	把	1
11	ZQ1194R	圆骨刀 (胶木柄)	260×9, 短弧, 圆口, 超薄刃	把	1
12	ZQ1189R	圆骨刀 (胶木柄)	260×12, 长弧, 圆口, 超薄刃	把	1
13	ZQ1237R	圆骨刀 (胶木柄)	260×12, 直圆头, 超薄刃	把	1
14	ZQ1200R	圆骨刀 (胶木柄)	260×15°×15, 前弯, 圆口, 超薄刃	把	1
15	ZQ1204R	圆骨刀 (胶木柄)	260×15°×12, 后弯, 圆口, 超薄刃	把	1
16	ZQ1210R	圆骨刀 (胶木柄)	260×10, 直平口, 超薄刃	把	1
17	ZQ1224R	圆骨刀 (胶木柄)	260×8, 枪形, 超薄斜刃	把	1
18	ZQ1225R	圆骨刀 (胶木柄)	260×10, 枪形, 超薄斜刃	把	1
19	ZQ437R	颈椎骨刀	220×9, 直平刃	把	1
20	ZQ1886R	鹅眉型骨凿 (扁胶木柄)	260×10, 直头平口	把	1

骨刮匙 (六方柄)  
Bone Curette left curved



ZQ440R 150x2 左V头 Left  
ZQ441R 150x3 左V头 Left

ZQ442R 150x2 右V头 Right  
ZQ443R 150x3 右V头 Right



★ZQ444R 170x3 左弯头 Left Curved  
★ZQ445R 170x6 左弯头 Left Curved



★ZQ446R 170x3 右弯头 Right Curved  
★ZQ447R 170x6 右弯头 Right Curved

骨刮匙  
Bone Curette



★ZQ638R 160x3

★ZQ637R 160x2

★ZQ639R 160x4

骨刮匙 (六方柄)  
Bone Curette



★ZQ448R 170x2  
★ZQ449R 170x3  
★ZQ450R 170x4  
★ZQ451R 170x5  
★ZQ452R 170x6

★ZQ453R 170x8  
★ZQ454R 170x10  
ZQ455R 170x12  
ZQ456R 170x14  
★ZQ457R 210x3

★ZQ458R 210x4  
★ZQ459R 210x5  
★ZQ460R 210x6  
★ZQ461R 210x8

★ZK633R 200x5  
★ZK635R 200x8  
★ZK705R 220x3  
★ZK706R 220x4

★ZQ511R 230x3  
★ZQ512R 230x4  
★ZQ513R 230x5  
★ZQ514R 230x6  
★ZQ515R 230x8  
★ZQ516R 230x10

★ZQ517R 230x12  
ZQ518R 230x14  
★ZQ519R 250x3  
★ZQ520R 250x4  
★ZQ521R 250x5  
★ZQ522R 250x6

★ZQ523R 250x8  
★ZQ524R 250x10  
ZQ525R 250x12  
★ZQ526R 250x14  
★ZQ527R 270x3  
ZQ528R 270x4

★ZQ529R 270x5  
★ZQ530R 270x6  
★ZQ531R 270x8  
★ZQ532R 270x10  
★ZQ533R 270x12  
ZQ534R 270x14

骨刮匙 (六方柄)  
Bone Curette



ZQ500R 250x3x110°, 角弯

骨刮匙 (带刻度, 六方柄)  
Bone Curette, graduated

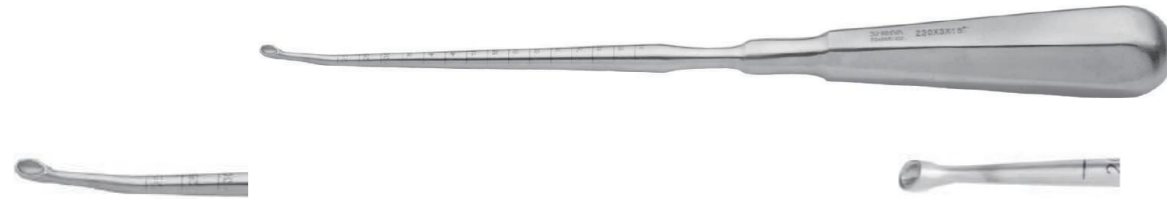

- |                   |                   |                   |                           |
|-------------------|-------------------|-------------------|---------------------------|
| ★ZQ462R 230x2x10° | ZQ472R 230x3x25°  | ★ZQ481R 250x6x15° | ★ZQ491R 250x3x45°, 后弯, 反口 |
| ★ZQ463R 230x3x10° | ★ZQ473R 230x4x25° | ZQ482R 250x4x20°  | ZQ492R 250x4x45°, 后弯, 反口  |
| ★ZQ464R 230x4x10° | ZQ474R 230x2x30°  | ZQ483R 250x5x20°  | ZQ493R 250x5x45°, 后弯, 反口  |
| ★ZQ465R 230x2x15° | ZQ475R 230x3x30°  | ★ZQ484R 250x6x20° |                           |
| ★ZQ466R 230x3x15° | ★ZQ476R 230x4x30° | ZQ485R 250x4x25°  |                           |
| ★ZQ467R 230x4x15° | ★ZQ477R 250x4x10° | ZQ486R 250x5x25°  |                           |
| ZQ468R 230x2x20°  | ★ZQ478R 250x5x10° | ZQ487R 250x6x25°  |                           |
| ★ZQ469R 230x3x20° | ★ZQ479R 250x6x10° | ZQ488R 250x4x30°  |                           |
| ★ZQ470R 230x4x20° | ★ZQ480R 250x4x15° | ZQ489R 250x5x30°  |                           |
| ZQ471R 230x2x25°  | ★ZQ439R 250x5x15° | ★ZQ490R 250x6x30° |                           |

骨刮匙 (六方柄)  
Bone Curette



- |                   |                   |
|-------------------|-------------------|
| ZQ494R 250x3, 后躬式 | ZQ496R 250x5, 后躬式 |
| ZQ495R 250x4, 后躬式 | ZQ731R 250x6, 后躬式 |

骨刮匙 (滚花柄)  
Bone Curette



- |                              |                              |                         |
|------------------------------|------------------------------|-------------------------|
| ★ZQ497R 280x2x30°, 前弯 curved | ★ZQ499R 280x4x30°, 前弯 curved | ★ZQ505R 280x11 straight |
| ★ZQ498R 280x3x30°, 前弯 curved | ★ZQ504R 280x7 straight       | ★ZQ506R 280x14 straight |

颈椎骨刮匙 (铝合金柄)  
Bone Curette With aluminum handle



- |  |   |
|--|---|
| ★ZQ1110RN 250x2, 直头, 枪状 straight           | ZQ1122RN 250x3x5°, 单弯前, 枪状 front curved   |
| ★ZQ1111RN 250x3, 直头, 枪状 straight           | ZQ1123RN 250x3x10°, 单弯前, 枪状 front curved  |
| ★ZQ1112RN 250x4, 直头, 枪状 straight           | ZQ1124RN 250x3x15°, 单弯前, 枪状 front curved  |
| ZQ1113RN 250x5, 直头, 枪状 straight            | ★ZQ1125RN 250x3x20°, 单弯前, 枪状 front curved |
| ★ZQ1114RN 250x2x 45°, 单弯前, 枪状 front curved | ZQ1126RN 250x4x 5°, 单弯前, 枪状 front curved  |
| ★ZQ1115RN 250x3x 45°, 单弯前, 枪状 front curved | ZQ1127RN 250x4x 10°, 单弯前, 枪状 front curved |
| ZQ1116RN 250x4x45°, 单弯前, 枪状 front curved   | ZQ1128RN 250x4x15°, 单弯前, 枪状 front curved  |
| ZQ1117RN 250x5x 45°, 单弯前, 枪状 front curved  | ZQ1129RN 250x4x 20°, 单弯前, 枪状 front curved |
| ★ZQ1118RN 250x2x 45°, 单弯后, 枪状 back curved  | ZQ1130RN 250x5x 5°, 单弯前, 枪状 front curved  |
| ★ZQ1119RN 250x3x45°, 单弯后, 枪状 back curved   | ZQ1131RN 250x5x10°, 单弯前, 枪状 front curved  |
| ZQ1120RN 250x4x 45°, 单弯后, 枪状 back curved   | ZQ1132RN 250x5x 15°, 单弯前, 枪状 front curved |
| ZQ1121RN 250x5x 45°, 单弯后, 枪状 back curved   | ZQ1133RN 250x5x 20°, 单弯前, 枪状 front curved |

骨刮匙 (铝合金柄)  
Bone Curette



- |                                      |                                     |
|--------------------------------------|-------------------------------------|
| ★ZQ1017RN 300x2x5°, 前弯 front curved  | ZQ1042RN 300x5x10°, 前弯 front curved |
| ZQ1018RN 300x2x10°, 前弯 front curved  | ZQ1044RN 300x5x20°, 前弯 front curved |
| ★ZQ1025RN 300x3x5°, 前弯 front curved  | ZQ1049RN 300x6x5°, 前弯 front curved  |
| ZQ1026RN 300x3x10°, 前弯 front curved  | ZQ1050RN 300x6x10°, 前弯 front curved |
| ★ZQ1030RN 300x4, 直 straight          | ZQ1051RN 300x6x15°, 前弯 front curved |
| ZQ1033RN 300x4x5°, 前弯 front curved   | ZQ1053RN 300x6x25°, 前弯 front curved |
| ★ZQ1034RN 300x4x10°, 前弯 front curved | ZQ1062RN 300x8, 直 straight          |
| ZQ1035RN 300x4x15°, 前弯 front curved  | ZQ1063RN 300x8x5°, 前弯 front curved  |
| ZQ1038RN 300x5, 直 straight           | ZQ1064RN 300x8x10°, 前弯 front curved |
| ★ZQ1041RN 300x5x5°, 前弯 front curved  |                                     |

双头骨刮匙  
Bone Curette



- |                      |                       |                       |
|----------------------|-----------------------|-----------------------|
| ★ZQ535R 160xφ2/3x9.5 | ★ZQ537R 180xφ6/7x15   | ★ZQ539R 210xφ10/11x18 |
| ★ZQ536R 160xφ4/5x13  | ★ZQ538R 180xφ8/9x16.5 | ★ZQ540R 210xφ12/13x20 |

双头骨刮匙  
Bone Curette



- |                     |                     |                      |
|---------------------|---------------------|----------------------|
| ★ZK847R 200xφ6/5x10 | ★ZK848R 200xφ8/7x14 | ★ZK849R 200xφ10/9x17 |
|---------------------|---------------------|----------------------|

骨刮匙 (硅胶柄)  
Bone Curette, with silicon handle

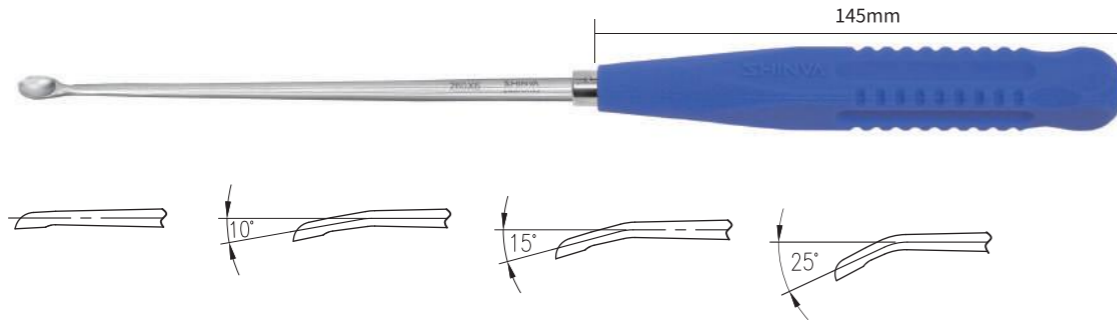

- |                                     |                                      |
|-------------------------------------|--------------------------------------|
| ★ZQ1340R 260x1 ,直 straight          | ★ZQ1439R 300x2 ,直 straight           |
| ZQ1341R 260x1x10° ,前弯 front curved  | ZQ1441R 300x2x10° ,前弯 front curved   |
| ZQ1342R 260x1x15° ,前弯 front curved  | ZQ1442R 300x2x15° ,前弯 front curved   |
| ZQ1344R 260x1x25° ,前弯 front curved  | ZQ1444R 300x2x25° ,前弯 front curved   |
| ★ZQ1345R 260x2 ,直 straight          | ★ZQ1445R 300x3 ,直 straight           |
| ZQ1346R 260x2x10° ,前弯 front curved  | ★ZQ1449R 300x3x10° ,前弯 front curved  |
| ★ZQ1347R 260x2x15° ,前弯 front curved | ZQ1450R 300x3x15° ,前弯 front curved   |
| ZQ1349R 260x2x25° ,前弯 front curved  | ZQ1452R 300x3x25° ,前弯 front curved   |
| ★ZQ1350R 260x3 ,直 straight          | ★ZQ1453R 300x4 ,直 straight           |
| ★ZQ1354R 260x3x10° ,前弯 front curved | ZQ1457R 300x4x10° ,前弯 front curved   |
| ★ZQ1355R 260x3x15° ,前弯 front curved | ZQ1458R 300x4x15° ,前弯 front curved   |
| ZQ1357R 260x3x25° ,前弯 front curved  | ZQ1460R 300x4x25° ,前弯 front curved   |
| ★ZQ1358R 260x4 ,直 straight          | ★ZQ1461R 300x5 ,直 straight           |
| ★ZQ1362R 260x4x10° ,前弯 front curved | ★ZQ1465R 300x5x10° ,前弯 front curved  |
| ★ZQ1363R 260x4x15° ,前弯 front curved | ZQ1466R 300x5x15° ,前弯 front curved   |
| ZQ1365R 260x4x25° ,前弯 front curved  | ZQ1468R 300x5x25° ,前弯 front curved   |
| ★ZQ1366R 260x5 ,直 straight          | ★ZQ1469R 300x6 ,直 straight           |
| ★ZQ1370R 260x5x10° ,前弯 front curved | ZQ1473R 300x6x10° ,前弯 front curved   |
| ZQ1371R 260x5x15° ,前弯 front curved  | ZQ1474R 300x6x15° ,前弯 front curved   |
| ZQ1373R 260x5x25° ,前弯 front curved  | ZQ1476R 300x6x25° ,前弯 front curved   |
| ★ZQ1374R 260x6 ,直 straight          | ★ZQ1477R 300x7 ,直 straight           |
| ZQ1378R 260x6x10° ,前弯 front curved  | ZQ1481R 300x7x10° ,前弯 front curved   |
| ZQ1379R 260x6x15° ,前弯 front curved  | ZQ1482R 300x7x15° ,前弯 front curved   |
| ZQ1381R 260x6x25° ,前弯 front curved  | ZQ1484R 300x7x25° ,前弯 front curved   |
| ★ZQ1382R 260x7 ,直 straight          | ★ZQ1485R 300x8 ,直 straight           |
| ZQ1386R 260x7x10° ,前弯 front curved  | ZQ1487R 300x8x10° ,前弯 front curved   |
| ZQ1387R 260x7x15° ,前弯 front curved  | ZQ1488R 300x9 ,直 straight            |
| ZQ1389R 260x7x25° ,前弯 front curved  | ZQ1490R 300x9x10° ,前弯 front curved   |
| ZQ1433R 300x1 ,直 straight           | ★ZQ1491R 300x10 ,直 straight          |
| ZQ1435R 300x1x10° ,前弯 front curved  | ★ZQ1493R 300x10x10° ,前弯 front curved |
| ZQ1436R 300x1x15° ,前弯 front curved  | ZQ1494R 300x12 ,直 straight           |
| ZQ1438R 300x1x25° ,前弯 front curved  | ZQ1496R 300x12x10° ,前弯 front curved  |
|                                     | ZQ1497R 300x15 ,直 straight           |
|                                     | ZQ1499R 300x15x10° ,前弯 front curved  |

骨刮匙 (硅胶柄)  
Bone Curette Left Curved



- |                   |                  |                   |                  |
|-------------------|------------------|-------------------|------------------|
| Left curved       | Left curved      | Right curved      | Right curved     |
| ★ZQ1351R 260x3,左弯 | ZQ1446R 300x3,左弯 | ★ZQ1352R 260x3,右弯 | ZQ1447R 300x3,右弯 |
| ZQ1359R 260x4,左弯  | ZQ1454R 300x4,左弯 | ★ZQ1360R 260x4,右弯 | ZQ1455R 300x4,右弯 |
| ZQ1367R 260x5,左弯  | ZQ1462R 300x5,左弯 | ★ZQ1368R 260x5,右弯 | ZQ1463R 300x5,右弯 |
| ZQ1375R 260x6,左弯  | ZQ1470R 300x6,左弯 | ZQ1376R 260x6,右弯  | ZQ1471R 300x6,右弯 |
| ZQ1383R 260x7,左弯  | ZQ1478R 300x7,左弯 | ZQ1384R 260x7,右弯  | ZQ1479R 300x7,右弯 |

骨刮匙 (硅胶柄)  
Bone Curette Serrated



- |                  |                  |                  |
|------------------|------------------|------------------|
| ★ZQ1500R 300x4,直 | ★ZQ1503R 300x7,直 | ZQ1505R 300x9,直  |
| ★ZQ1501R 300x5,直 | ★ZQ1504R 300x8,直 | ZQ1506R 300x10,直 |
| ★ZQ1502R 300x6,直 |                  |                  |

骨刮匙 (硅胶柄)  
Bone Curette, front curved



- |                        |                        |                        |
|------------------------|------------------------|------------------------|
| ZQ2351R 300x2x10° ,前弯  | ★ZQ2360R 300x2x20° ,前弯 | ★ZQ1573R 300x2x45° ,弯头 |
| ★ZQ2352R 300x3x10° ,前弯 | ★ZQ2361R 300x3x20° ,前弯 | ★ZQ1574R 300x3x45° ,弯头 |
| ZQ2353R 300x4x10° ,前弯  | ★ZQ2362R 300x4x20° ,前弯 | ★ZQ1575R 300x4x45° ,弯头 |
| ★ZQ2354R 300x5x10° ,前弯 | ★ZQ2363R 300x5x20° ,前弯 | ★ZQ1576R 300x5x45° ,弯头 |
| ★ZQ2355R 300x6x10° ,前弯 | ★ZQ2364R 300x6x20° ,前弯 | ★ZQ1577R 300x6x45° ,弯头 |
|                        |                        | ZQ1578R 300x8x45° ,弯头  |

空心骨刮匙 (硅胶柄)  
Bone Curette



- |                      |
|----------------------|
| ZQ1300R 270x3,方头,弯曲型 |
| ZQ1301R 270x4,方头,弯曲型 |

骨刮匙 (硅胶柄)  
Bone Curette

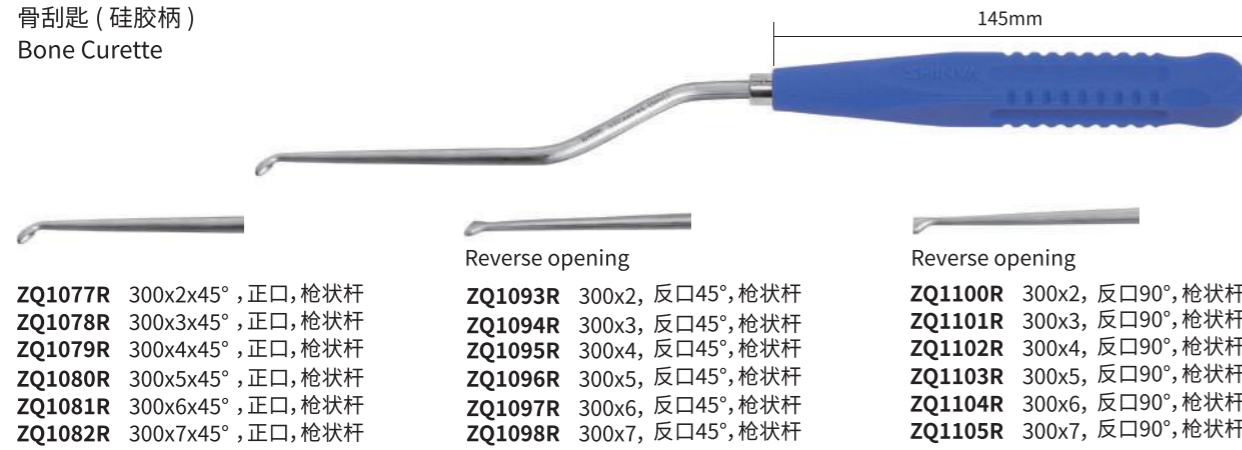

- ZQ1077R 300x2x45°, 正口, 枪状杆
- ZQ1078R 300x3x45°, 正口, 枪状杆
- ZQ1079R 300x4x45°, 正口, 枪状杆
- ZQ1080R 300x5x45°, 正口, 枪状杆
- ZQ1081R 300x6x45°, 正口, 枪状杆
- ZQ1082R 300x7x45°, 正口, 枪状杆

Reverse opening

- ZQ1093R 300x2, 反口45°, 枪状杆
- ZQ1094R 300x3, 反口45°, 枪状杆
- ZQ1095R 300x4, 反口45°, 枪状杆
- ZQ1096R 300x5, 反口45°, 枪状杆
- ZQ1097R 300x6, 反口45°, 枪状杆
- ZQ1098R 300x7, 反口45°, 枪状杆

Reverse opening

- ZQ1100R 300x2, 反口90°, 枪状杆
- ZQ1101R 300x3, 反口90°, 枪状杆
- ZQ1102R 300x4, 反口90°, 枪状杆
- ZQ1103R 300x5, 反口90°, 枪状杆
- ZQ1104R 300x6, 反口90°, 枪状杆
- ZQ1105R 300x7, 反口90°, 枪状杆

空心骨刮匙 (硅胶柄)  
Bone Curette



- ★ZQ1302R 270x4, 直, 方头
- ★ZQ1303R 270x5, 直, 方头

- ★ZQ1311R 270x8
- ZQ1312R 270x9
- ZQ1313R 270x10

- ZQ1314R 270x7.2x6.3
- ZQ1315R 270x8.0x7.2
- ZQ1316R 270x9.0x8.5

- ZQ1304R 280x6.5x5, 长槽型

- ★ZQ1305R 270x8x3.4, 椭圆形, 直头, 颈椎型
- ★ZQ1307R 270x8x5, 椭圆形, 直头, 胸椎型
- ★ZQ1309R 270x8x7, 椭圆形, 直头, 腰椎型

- ZQ1306R 270x8x3.4x25°, 弯, 颈椎型
- ★ZQ1308R 270x8x5x25°, 弯, 胸椎型
- ZQ1310R 270x8x7x25°, 弯, 腰椎型

颈椎骨刮匙 (铝合金)  
Bone curette with aluminum handle

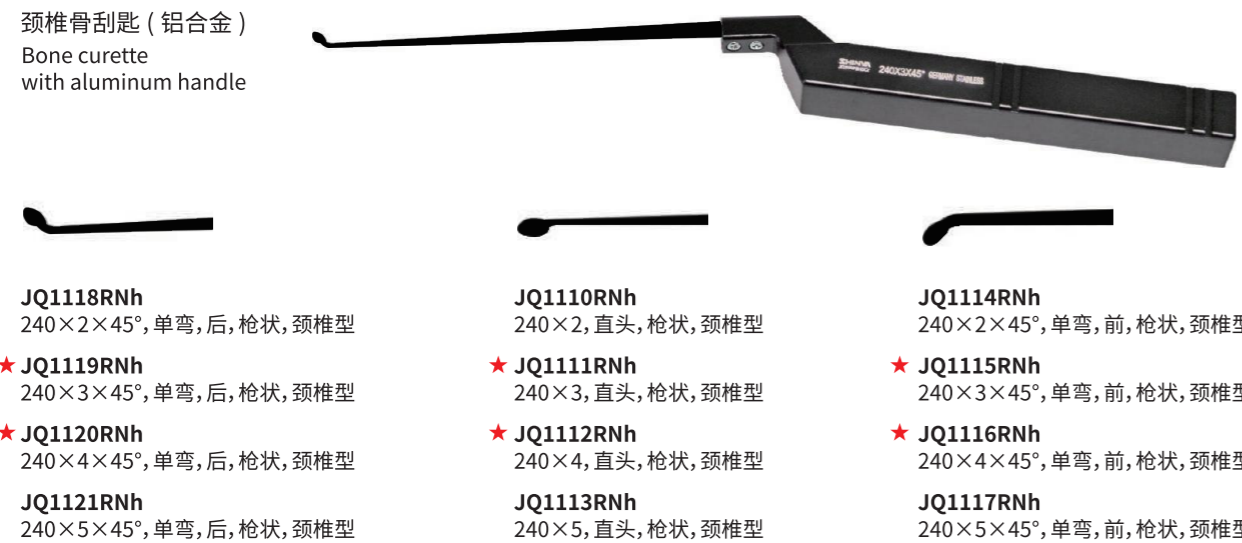

- JQ1118RNh 240x2x45°, 单弯, 后, 枪状, 颈椎型
- ★JQ1119RNh 240x3x45°, 单弯, 后, 枪状, 颈椎型
- ★JQ1120RNh 240x4x45°, 单弯, 后, 枪状, 颈椎型
- JQ1121RNh 240x5x45°, 单弯, 后, 枪状, 颈椎型

- JQ1110RNh 240x2, 直头, 枪状, 颈椎型
- ★JQ1111RNh 240x3, 直头, 枪状, 颈椎型
- ★JQ1112RNh 240x4, 直头, 枪状, 颈椎型
- JQ1113RNh 240x5, 直头, 枪状, 颈椎型

- JQ1114RNh 240x2x45°, 单弯, 前, 枪状, 颈椎型
- ★JQ1115RNh 240x3x45°, 单弯, 前, 枪状, 颈椎型
- ★JQ1116RNh 240x4x45°, 单弯, 前, 枪状, 颈椎型
- JQ1117RNh 240x5x45°, 单弯, 前, 枪状, 颈椎型

骨刮匙 (硅胶柄)  
Bone Curette  
With silicon handle

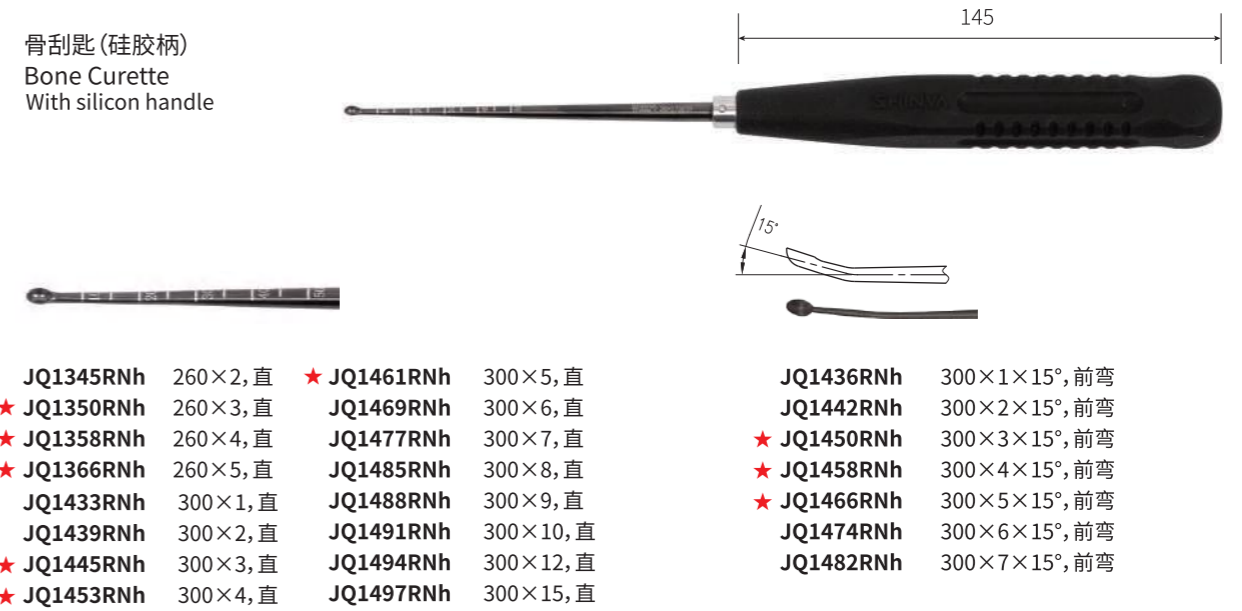

- JQ1345RNh 260x2, 直
- ★JQ1350RNh 260x3, 直
- ★JQ1358RNh 260x4, 直
- ★JQ1366RNh 260x5, 直
- JQ1433RNh 300x1, 直
- JQ1439RNh 300x2, 直
- ★JQ1445RNh 300x3, 直
- ★JQ1453RNh 300x4, 直

- ★JQ1461RNh 300x5, 直
- JQ1469RNh 300x6, 直
- JQ1477RNh 300x7, 直
- JQ1485RNh 300x8, 直
- JQ1488RNh 300x9, 直
- JQ1491RNh 300x10, 直
- JQ1494RNh 300x12, 直
- JQ1497RNh 300x15, 直

- JQ1436RNh 300x1x15°, 前弯
- JQ1442RNh 300x2x15°, 前弯
- ★JQ1450RNh 300x3x15°, 前弯
- ★JQ1458RNh 300x4x15°, 前弯
- ★JQ1466RNh 300x5x15°, 前弯
- JQ1474RNh 300x6x15°, 前弯
- JQ1482RNh 300x7x15°, 前弯

Serrated

- ★JQ1500RNh 300x4, 直, 带齿
- ★JQ1501RNh 300x5, 直, 带齿
- ★JQ1502RNh 300x6, 直, 带齿
- JQ1503RNh 300x7, 直, 带齿
- JQ1504RNh 300x8, 直, 带齿
- JQ1505RNh 300x9, 直, 带齿
- JQ1506RNh 300x10, 直, 带齿

- JQ1569RNh 300x2x15°, 前弯
- ★JQ1570RNh 300x3x15°, 前弯
- ★JQ1571RNh 300x4x15°, 前弯
- ★JQ1572RNh 300x5x15°, 前弯
- JQ1581RNh 260x2x15°, 前弯
- ★JQ1584RNh 260x3x15°, 前弯
- ★JQ1587RNh 260x4x15°, 前弯
- ★JQ1590RNh 260x5x15°, 前弯

- JQ1510RNh 300x2x30°, 前弯
- ★JQ1511RNh 300x3x30°, 前弯
- ★JQ1512RNh 300x4x30°, 前弯
- ★JQ1513RNh 300x5x30°, 前弯
- JQ1582RNh 260x2x30°, 前弯
- ★JQ1585RNh 260x3x30°, 前弯
- ★JQ1588RNh 260x4x30°, 前弯
- ★JQ1591RNh 260x5x30°, 前弯

骨刮匙  
Bone Curette

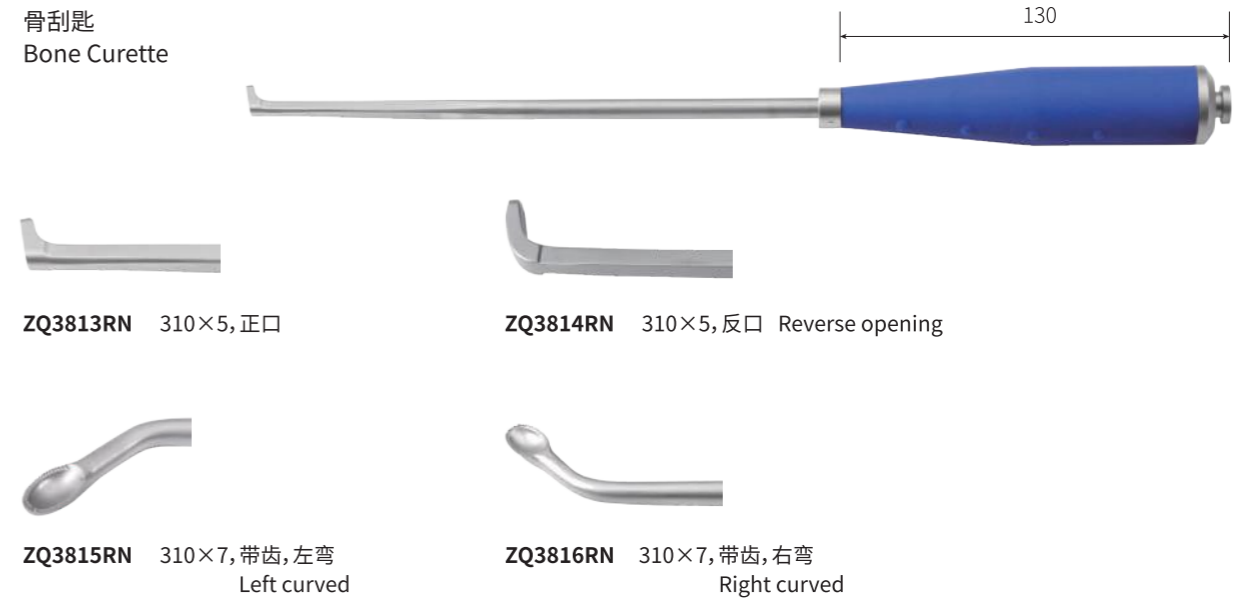

- ZQ3813RN 310x5, 正口

- ZQ3814RN 310x5, 反口 Reverse opening

- ZQ3815RN 310x7, 带齿, 左弯  
Left curved

- ZQ3816RN 310x7, 带齿, 右弯  
Right curved

骨把持器 (骨折固定夹)  
Bone Clamp



★ ZK190R 小 150      ★ ZK191R 中 183      ★ ZK192R 大 215

带尖复位钳  
Reposition Forceps



★ ZK165R 190      ★ ZK232R 260      ZK229RN 110  
★ ZK166R 210      ★ ZK186R 155

复位钳  
Reposition Forceps



ZQ3612RN 200×90, 带尖

复位钳  
Reposition Forceps



★ ZK164R 170      ★ ZK163R 230

三爪复位钳  
Reposition Forceps



★ ZK169R 200

骨科复位钳  
Reposition Forceps



★ ZK233R 400      ★ ZK234R 440  
最大张口16.5cm      最大张口22cm  
Max. opening 16.5cm      Max. opening 22cm

骨科复位钳  
Reposition Forceps



ZK237R  
340  
带导向,  
张口最大120  
Max. opening 120

骨科复位钳  
Reposition Forceps



★ ZK235R 390  
最大张口16cm  
Max. opening 16cm

弯头复位钳  
Reposition Forceps  
★ZK176R 240  
★ZK177R 270



直头复位钳  
Reposition Forceps  
★ZK178R 300



双爪复位钳  
Reposition Forceps  
★ZK173R 415



不对称双爪复位钳  
Reposition Forceps  
★ZK175R 415



骨科复位钳(带尖活络座)  
★ZQ629R φ25×14, 6尖



三爪复位钳  
Reposition Forceps  
★ZK174R 415



顶棒  
Rod  
★ZQ957R 300



髌臼复位钳  
Reposition Forceps  
★ZK179R 340, 撑开及压缩两用



椎体复位器  
Reposition Forceps  
ZQ1534R 230x10x5°, 弯



胫骨平台复位器  
Reposition Forceps  
★ZQ1262R 200



手指持骨钳  
Bone Clamp  
★ ZK227R 170



侧弯持骨钳  
Bone Clamp  
★ ZK228R 140



腕骨复位钳  
Wrist Reposition Forceps  
ZK183RN 155, 弯  
★ ZK184RN 185, 弯  
注:孔φ1.6  
Remark:Hole φ1.6



腕骨撑开钳  
Wrist Distractor  
ZK185RN 185, 弯  
注:孔φ1.6  
Remark:Hole φ1.6



骨科复位钳  
Reposition Forceps  
★ ZK188RB 140, 指圈式



多齿持骨钳  
Bone Holding Forceps  
★ ZK158R 200, 带自锁



多齿持骨钳  
Bone Holding Forceps  
★ ZK159R 250, 带自锁



多齿持骨钳  
Bone Holding Forceps  
★ ZK141R 260



中心化持骨钳  
Self-Centering Forceps  
★ ZK161R 190  
★ ZK162R 270



三爪自定中心持骨钳  
Bone Holding Forceps  
★ ZK226R 250



导向持骨钳  
Bone Holding Forceps  
ZK223R 小 small  
★ ZK224R 中 large  
★ ZK225R 大 medium



持骨钳  
Bone Clamp  
★ ZK151R 四齿



持骨钳  
Bone Clamp  
★ ZK137R 两齿



髌骨钳  
Patella Forceps  
★ ZK170R 190



软骨钳  
Cartilage Forceps  
★ ZQ1157R 200, 直(半月板器械) Straight  
★ ZQ1158R 200, 弯(半月板器械) Curved



骨科撑开器  
Knee Spreader

★ ZQ1323R 膝关节 195  
头宽20mm  
Tip width 20mm



骨科撑开器  
Spreader

★ ZQ1324R 230x16



骨科用撑开钳  
Distractor

ZQ3613RN 260×11  
ZQ3614RN 260×8



骨科用撑开钳  
Distractor

ZQ3406RN 180×8



骨科撑开器  
Spreader

★ ZQ1325R 170x40, 双孔  
孔  $\phi 2.6$ ,  $\phi 1.6$   
撑开最大距离 45mm  
holes:  $\phi 2.6$ ,  $\phi 1.6$   
max. opening: 45mm



骨科用撑开钳  
Distractor

★ ZQ4166RN  
210 双孔 撑开尺寸4~9cm  
孔  $\phi 2.6$ ,  $\phi 1.6$   
hole:  $\phi 2.6$ ,  $\phi 1.6$   
opening 4-9cm



骨科用撑开钳  
Distractor

★ ZQ4167RN  
220 双孔 撑开尺寸9~15cm  
孔  $\phi 2.6$ ,  $\phi 1.6$   
hole:  $\phi 2.6$ ,  $\phi 1.6$   
opening 9-15cm



骨科撑开器  
Spreader

★ ZQ1326R 180x7.5  
撑开最大距离 46mm  
max. opening: 46mm



骨科压缩钳  
Compressing Forceps

★ ZQ1545R 180x40, 双孔  
孔  $\phi 2.6$ ,  $\phi 1.6$   
holes:  $\phi 2.6$ ,  $\phi 1.6$



撑开钳  
Distractor

★ ZQ4138RN/RNh  
175x32, 双孔, 足踝, 克氏针



压缩钳  
Compress

★ ZQ4139RN/RNh  
170x32, 双孔



撑开钳  
Distractor

★ ZQ4140RN/RNh  
180



撑开钳  
Distractor

★ ZQ4141RN/RNh  
180



枪式复位钳  
Reposition Forceps

★ ZK236R 枪式

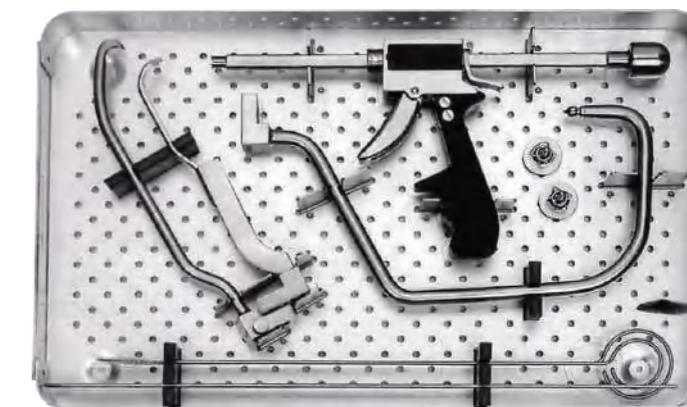
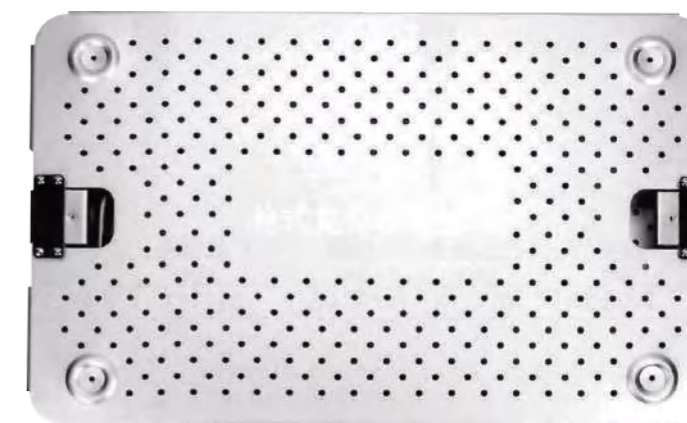

组合式系统:三种不同复位臂均可连接于滑动装置上  
Combined System:  
Three Different reset arms can be connected to the sliding device

四个方向上均可组装复位臂,根据骨折类型灵活操作  
Four directions can be assembled with the rest arm, according to the flexible operation of type of fracture

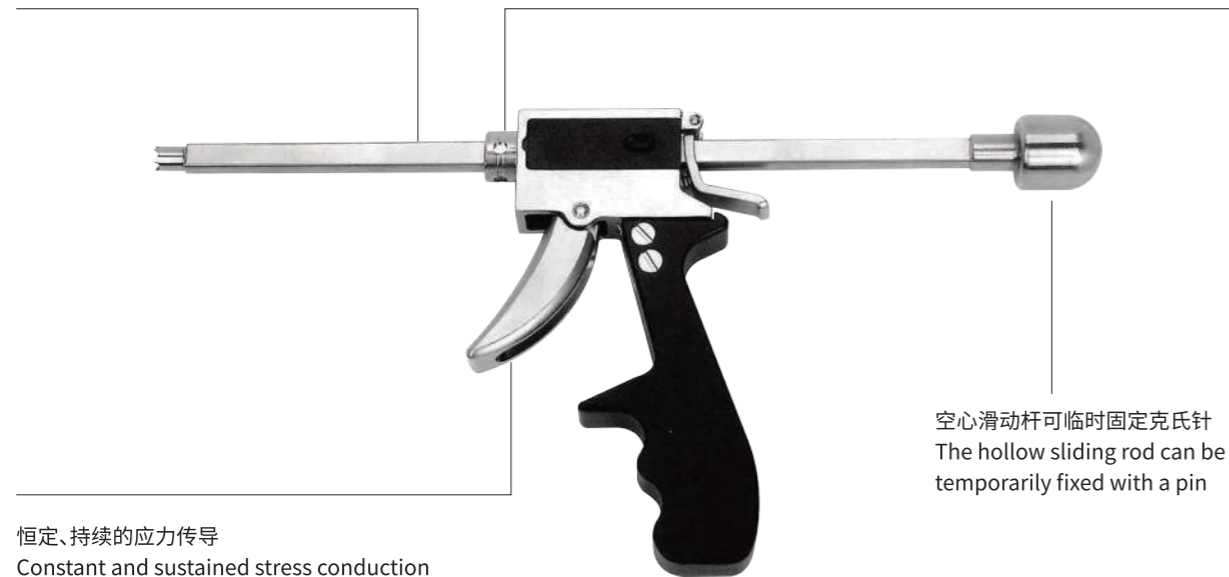

恒定、持续的应力传导  
Constant and sustained stress conduction



复位臂  
Reset Arm



骨盆复位臂  
Pelvis Reset Arm



经皮微创复位臂  
Minimally Invasive  
Percutaneous Reduction

钢丝剪  
Wire Cutting Scissors

★ ZK470RG 140, 指圈式, 钢丝 $\leq\phi 1.2$ , 钢针 $\leq\phi 0.8$   
for wire  $\leq \phi 1.2$ , for pin  $\leq \phi 0.8$



钢针剪  
Wire Cutting Scissors

★ ZK273R 200x $\phi 1.2$



钢针剪  
Wire Cutting Scissors

ZK276R 200x $\phi 2.5$   
★ ZK274R 240x $\phi 2.5$



钢针剪(钛网剪)

★ ZK281R 220x $\phi 1.2$



克氏剪  
KIRSCHNER Wire Cutting Scissors

★ ZK278R 205xΦ3.5, 圆头



钢针剪  
Wire Cutting Scissors

★ ZK475R 240xΦ2.5, 双面有刃



钢针剪  
Wire Cutting Scissors

★ ZK286RB 240×Φ3, 双关节



钢丝剪  
Wire Cutting Scissors

★ ZK283R/RN 215xΦ2.5, 双关节

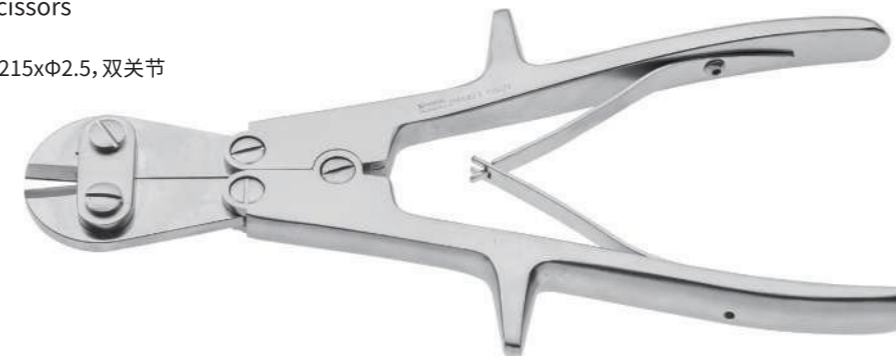

钢丝剪  
Wire Cutting Scissors

★ LS719R 500, 剪Φ6以下钢针 Cutting Rang: Less Than Φ6  
★ ZK275R 350x (Φ1-Φ4)



钢丝钳  
Wire Cutting Forceps

★ ZK500R 170 剪切范围Φ0.2-1.5钢丝  
cutting range: Φ0.2-1.5 wire



钢丝钳  
Wire Cutting Forceps

★ ZK261R 180 斜口 剪切范围≤Φ2  
cutting range ≤ Φ0.2



克氏钳  
KIRSCHNER Wire Cutting Forceps

★ ZK267R 200xφ2, 尖头



克丝(氏)钳  
KIRSCHNER Wire Cutting Forceps

剪切范围φ0.2—φ1.5钢丝  
cutting range: φ0.2-φ1.5wire

★ ZK263R 160 尖嘴, 薄腮

★ ZK264R 180 尖嘴, 薄腮



克氏钳  
KIRSCHNER Wire Cutting Forceps

★ ZK268R 200xφ2, 虎头



克氏钳  
KIRSCHNER Wire Cutting Forceps

★ ZK270R 210xφ2, 虎头



克氏钳  
KIRSCHNER Wire Cutting Forceps

★ ZK282R 235xφ2, 虎头



克氏钳  
KIRSCHNER Wire Cutting Forceps

★ ZK262R 180, 偏口, 钢丝≤φ1.5, 钢针≤φ1.2  
for wire ≤φ1.5, for pin ≤φ1.2



钢丝剪  
Wire Cutting Scissors

★ ZK280RB 28cm 双关节圆头交错刀, 钢针≤φ3.5  
for pin ≤φ3.5



钢针剪(台式断棒器)  
Pin cutter

★ ZK287RN 350xφ6



钢针剪  
TC Wire Cutting Scissors



- ★ JK279RB 220mm, φ2.2以下, 镶合金片 for wire less than φ2.2

钢丝结扎钳  
Wire holder



- ★ ZK488RG 135
- ★ ZK489RG 150
- ★ ZK492RG 160
- ★ ZK491RG 180
- ★ ZK493RG 200

钢丝结扎钳  
Wire holder



- ★ ZK495RB 150, 镶片 TC
- ★ ZK494RB 190, 镶片 TC

手指钢板弯曲器  
Plate Bender, one pair

- ★ ZQ632R 120



钢板折弯器  
Plate Bender, one pair

- ★ ZQ863R 200, 双头, 左右



骨板折弯器  
Plate Bender, one pair

- ★ ZQ859R II型, 左、右 (双槽200x3/4, 斜口)



骨板折弯器  
Plate Bender, one pair

- ★ ZQ861R III型, 左、右 (双槽280x5/6, 斜口)



克氏针折弯钳  
Kirschner Pin Bender  
★ ZK967R 克氏针折弯钳



弯棒器  
Bar Bender  
ZQ1281R 340



双向弯曲钳  
Two-way Bending  
Forceps  
★ ZQ908R 245, 双向



钢板折弯钳  
Steel Bender  
ZK1064RN/RNh 190  
ZK1063RN/RNh 140



牵开拉钩  
Retractor

- B  
★ ZQ641R 160X5小,直  
★ ZQ642R 160X10大,直



牵开拉钩  
Retractor

- B  
★ ZQ643R 140X2.5小,弯  
★ ZQ644R 140X4大,弯



小儿骨撬  
Child Bone Lever

- B  
★ ZQ568R 2X1 (套) set  
150×20  
150×15



骨撬 (霍夫曼拉钩)  
Bone Lever

- B  
★ ZQ569R 150X6  
★ ZQ570R 150X8  
★ ZQ571R 150X10  
★ ZQ572R 150X15



尖骨撬 (霍夫曼拉钩)  
Bone Lever

- B  
★ ZQ573R 240X10  
★ ZQ574R 240X15  
★ ZQ729R 240X20  
★ ZQ575R 240X25  
★ ZQ730R 240X30



尖骨撬 (霍夫曼拉钩)  
Bone Lever

- ★ ZQ576R 240X40



平骨撬 (霍夫曼拉钩)  
Bone Lever

- ★ ZQ577R 240X10
- ★ ZQ578R 240X15
- ★ ZQ773R 240X20
- ★ ZQ579R 240X25
- ★ ZQ774R 240X30
- ★ ZQ754R 240X18



平骨撬 (霍夫曼拉钩)  
Bone Lever

- ★ ZQ580R 240X42



骨撬  
Bone Lever

- ★ ZT539R 240×39, 弯



骨撬  
Bone Lever

- ★ ZT551R 230×3



骨撬  
Bone Lever

- ★ ZT552R 235×3



骨撬  
Bone Lever

- ★ ZT553R 240×3



骨撬  
Bone Lever

- ★ ZT547R 240×18



骨撬  
Bone Lever

- ★ ZT548R 235×18



骨撬  
Bone Lever

- ★ ZT544R 230×17



骨撬  
Bone Lever

- ★ ZT549R 215×18



骨撬  
Bone Lever

- ★ ZT840R 205×18, 弯



骨撬  
Bone Lever

- ★ ZT537R 250×25, 弯
- ★ ZT538R 250×35, 弯



骨撬  
Bone Lever  
★ ZT846R 275×28, 弯, 腕关节



骨撬  
Bone Lever  
★ ZT835R 300×28, 弯, 腕关节



骨撬  
Bone Lever  
★ ZT842R 260×31, 弯, 腕关节



骨撬  
Bone Lever  
ZT901RN 220×18, 弯



骨撬  
Bone Lever  
ZT902RN 300×15, 弯



骨撬  
Bone Lever  
★ ZT903RN 265×21, 弯



骨撬  
Bone Lever  
ZT904RN 270×21, 弯



骨撬 (高位胫骨截骨)  
Bone Lever  
ZT805R 285×12, 弯



骨撬 (高位胫骨截骨)  
Bone Lever  
★ ZT557R 弯, 225×5.5



骨撬  
Bone Lever  
ZT905RN 280×21, 弯



骨撬  
Bone Lever  
★ ZT847RN 320×32, 弯, 腕关节



直接前入路 (DAA) 微创全髋置换骨撬  
Direct Anterior Approach(DAA) MIS Hip Replacement Levers



骨撬  
Bone Lever  
★ ZT827R 350x25, 弯, 髋关节, 胶木柄  
★ ZT849R 340x34, 髋关节



骨撬 (胶木柄)  
Bone Lever  
★ ZT545R 310x25, 弯, 双钩

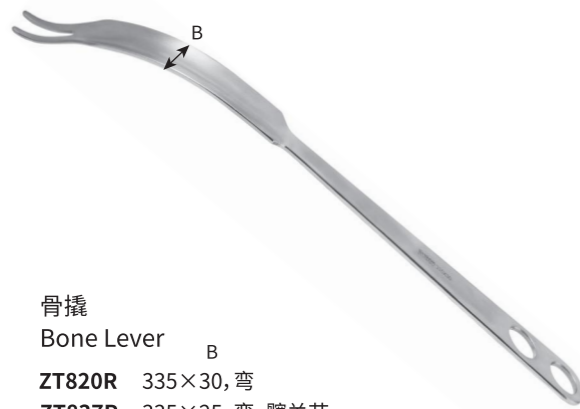

骨撬  
Bone Lever  
B  
ZT820R 335x30, 弯  
ZT837R 335x25, 弯, 髋关节



骨撬  
Bone Lever  
★ ZT826R 270x20, 弯, 髋关节



骨撬  
Bone Lever  
ZT591R 270x27, 弯, 髋关节



骨撬  
Bone Lever  
★ ZT583R 285x16, 弯, 髋关节



骨撬  
Bone Lever  
★ ZT575R 260x38, 弯, 髋关节



骨撬  
Bone Lever  
ZT803R 330x23, 弯, 髋关节



骨撬  
Bone Lever  
★ ZT567R 300x46, 弯, 髋关节

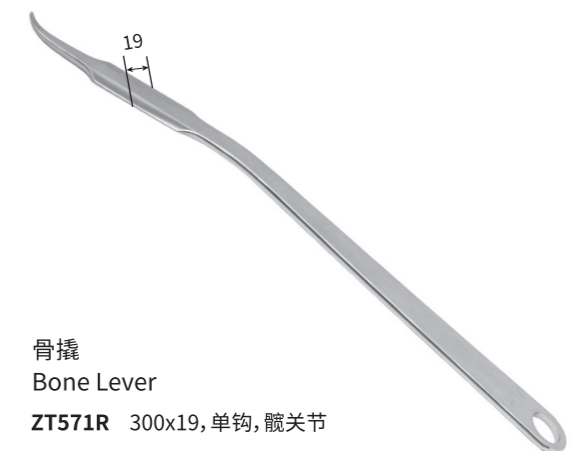

骨撬  
Bone Lever  
ZT571R 300x19, 单钩, 髋关节



骨撬  
Bone Lever  
★ ZT843R 260x25, 弯, 髋关节



骨撬  
Bone Lever  
★ ZT829R 230x27, 弯, 髋关节

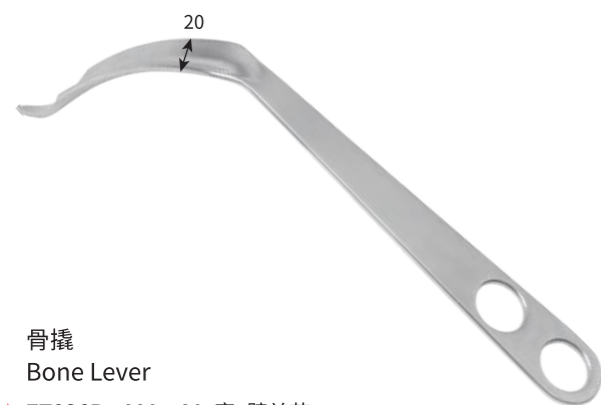

骨撬  
Bone Lever  
★ ZT836R 220×20, 弯, 髌关节



骨撬  
Bone Lever  
★ ZT830R 320×18, 弯, 髌关节



骨撬  
Bone Lever  
★ ZT839R 285×30, 弯, 髌关节



骨撬  
Bone Lever  
★ ZT828R 340×33, 弯, 髌关节

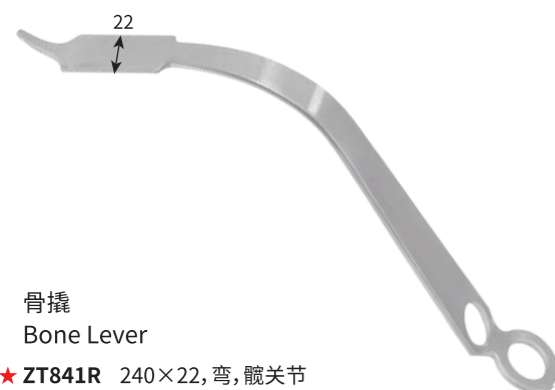

骨撬  
Bone Lever  
★ ZT841R 240×22, 弯, 髌关节



骨撬  
Bone Lever  
ZT838R 220×30, 弯, 髌关节

标准后侧入路小切口骨撬 (半髌置换)  
Posterior Approach Hemiarthroplasty Bone Lever



骨撬  
Bone Lever  
★ ZT576R 315×35, 有齿, 髌关节



骨撬  
Bone Lever  
★ ZT582R 255×23, 弯, 膝关节

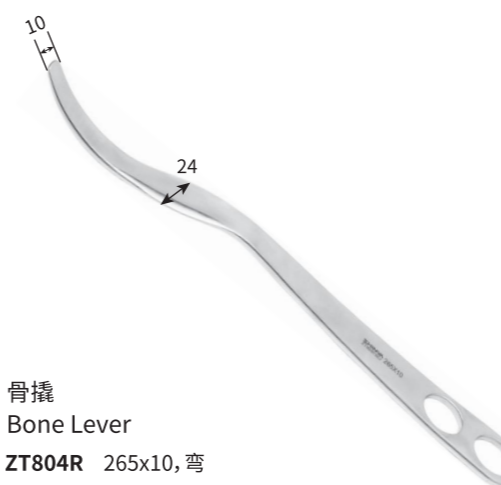

骨撬  
Bone Lever  
ZT804R 265×10, 弯



骨撬  
Bone Lever  
ZT821R 345×27, 弯

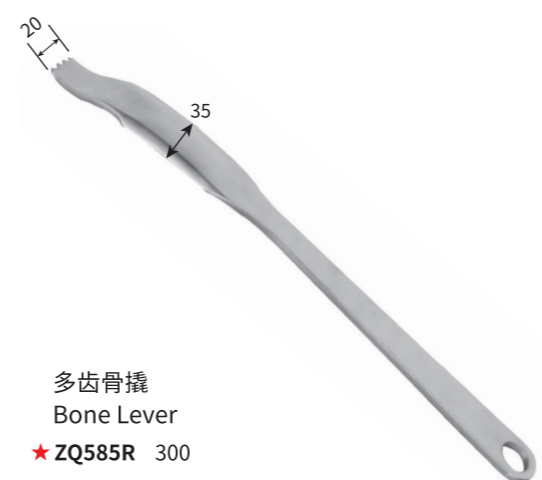

多齿骨撬  
Bone Lever  
★ ZQ585R 300

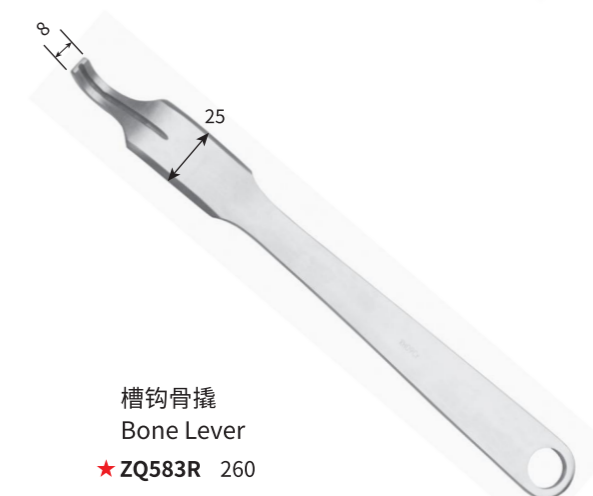

槽钩骨撬  
Bone Lever  
★ ZQ583R 260



骨撬  
Bone Lever  
ZT818R 233x20, 弯



骨撬  
Bone Lever  
ZT572R 280x20

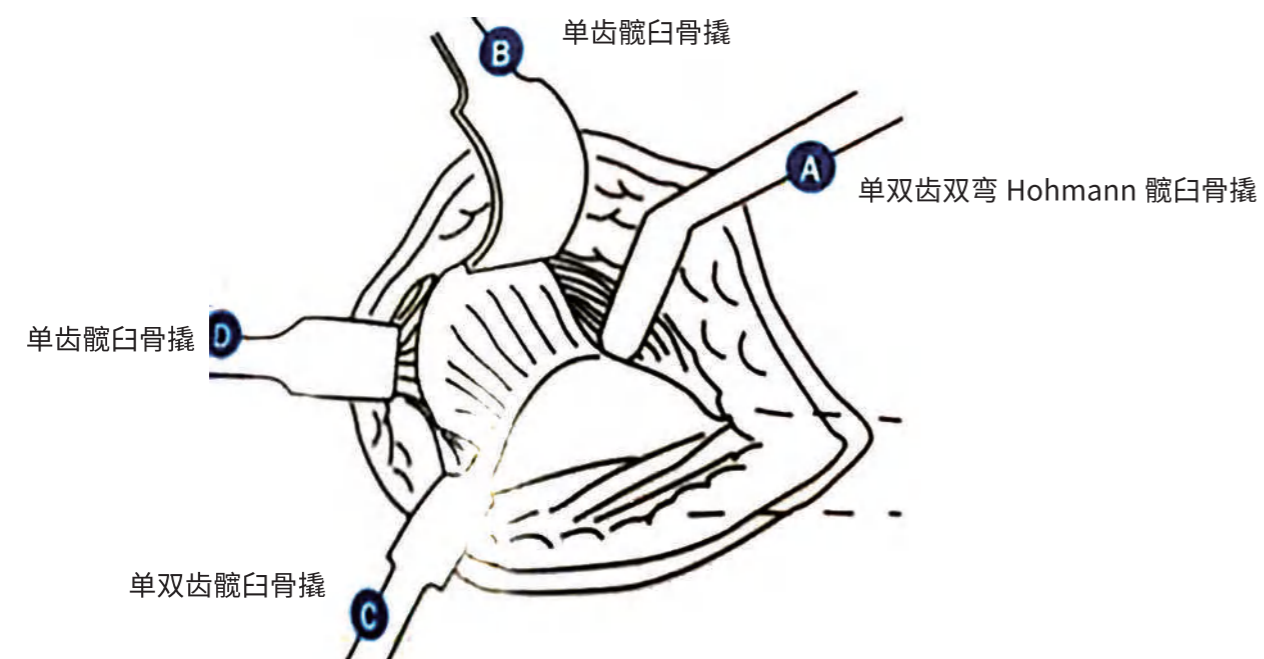

**A** 单双齿双弯 Hohmann 髌臼骨撬  
Hohmann Bone Lever

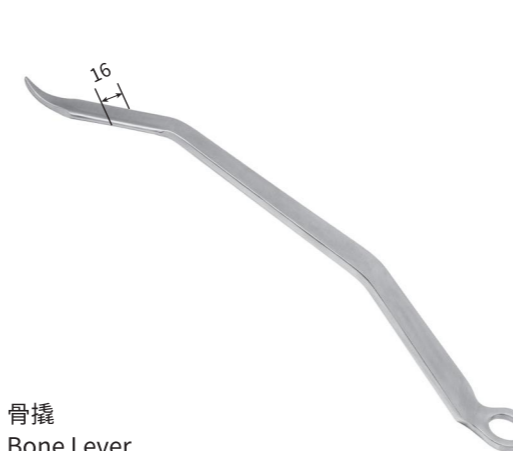

骨撬  
Bone Lever  
★ ZT573R 270x16, 弯, 髌关节

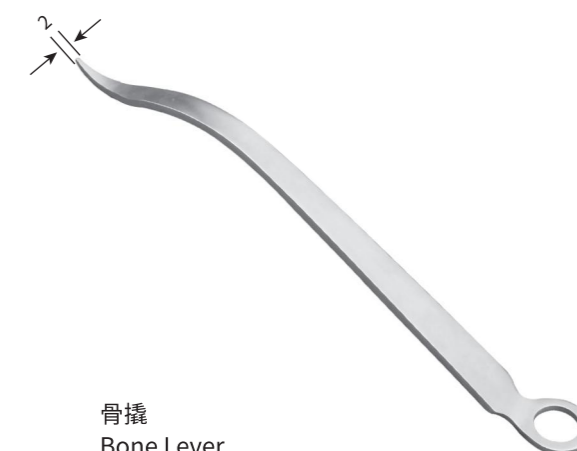

骨撬  
Bone Lever  
★ ZT554R 265x2

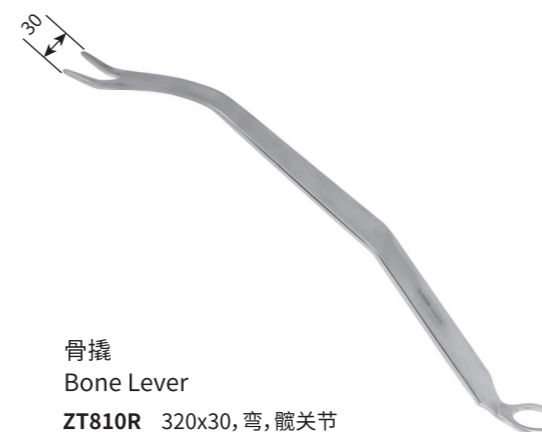

骨撬  
Bone Lever  
ZT810R 320x30, 弯, 髌关节

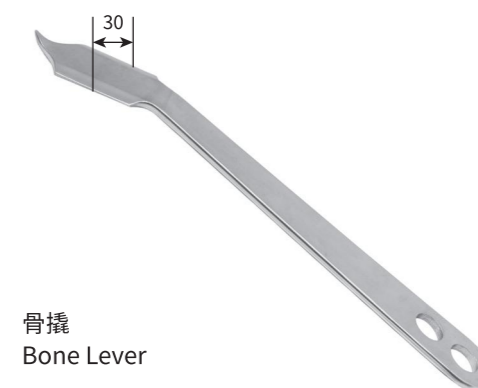

骨撬  
Bone Lever  
★ ZT566R 225x30, 弯, 髌关节

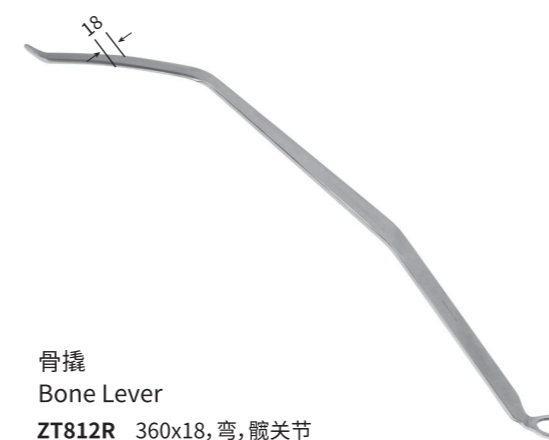

骨撬  
Bone Lever  
ZT812R 360x18, 弯, 髌关节

**B** 单齿髌臼骨撬  
Bone Lever

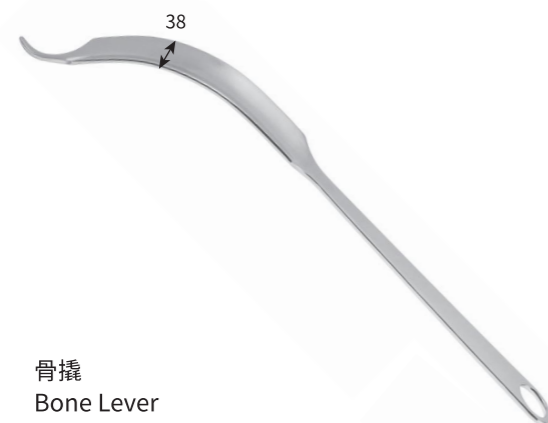

骨撬  
Bone Lever  
★ ZT574R 340x38, 单钩, 髌关节



骨撬  
Bone Lever  
★ ZT550R 325, 单钩

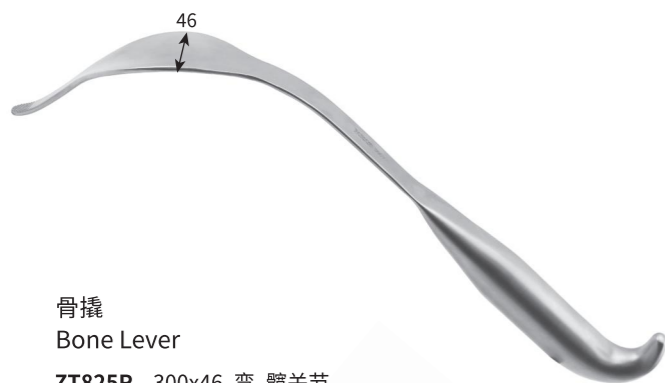

骨撬  
Bone Lever  
ZT825R 300x46 弯 髌关节

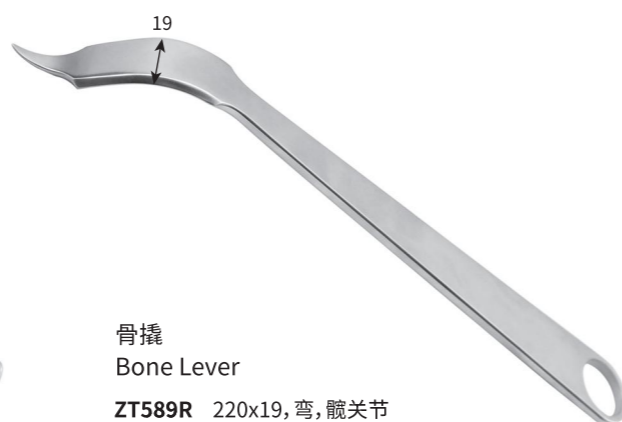

骨撬  
Bone Lever  
ZT589R 220x19, 弯, 髌关节

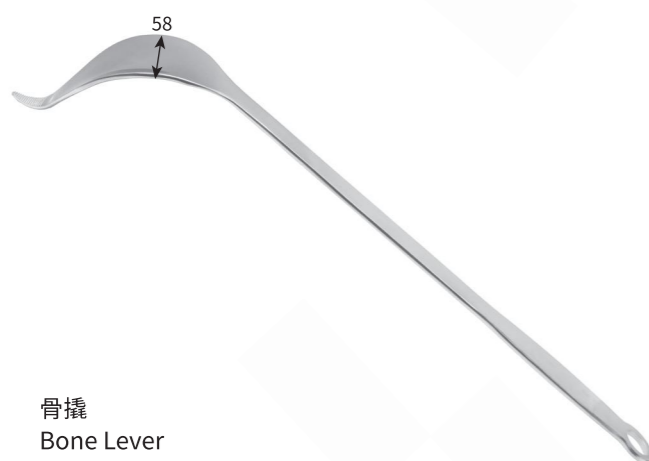

骨撬  
Bone Lever  
ZT592R 425x58, 有齿, 髌关节

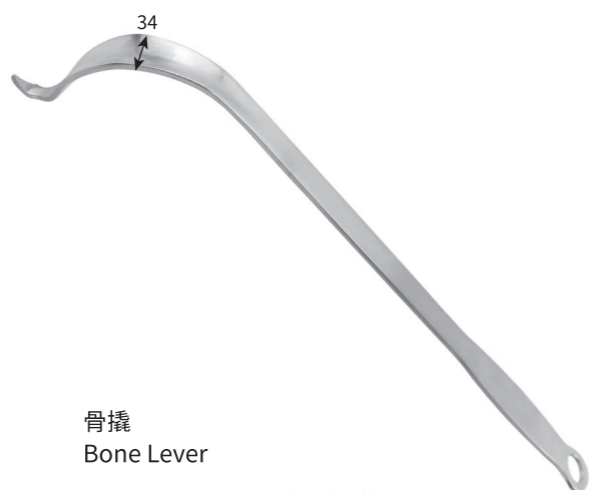

骨撬  
Bone Lever  
ZT593R 425x34, 有齿, 髌关节

**C** 单双齿髌臼骨撬  
Bone Lever



骨撬  
Bone Lever  
ZT813R 320x40, 弯, 髌关节



骨撬  
Bone Lever  
★ ZT561R 弯, 270x38



骨撬  
Bone Lever  
★ ZQ582R 280x28



骨撬  
Bone Lever  
ZT824R 300x28, 弯



骨撬  
Bone Lever  
ZT819R 300x28, 弯, 髌关节

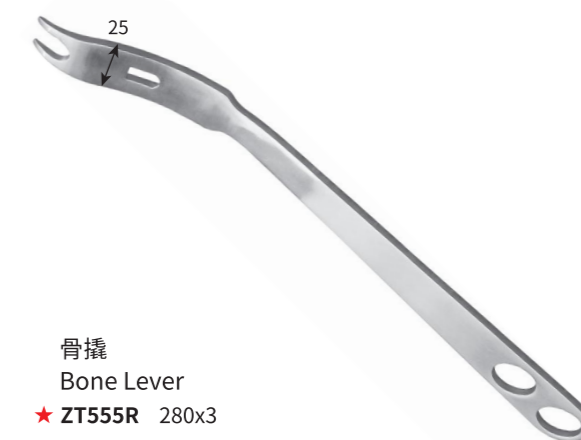

骨撬  
Bone Lever  
★ ZT555R 280x3



骨撬  
Bone Lever  
ZT834R 360×22, 弯, 髌关节



骨撬  
Bone Lever  
L B  
★ ZT558R 305×12, 弯  
★ ZT559R 305×18, 弯  
★ ZT560R 310×22, 弯  
ZT833R 300×32, 弯, 髌关节



骨撬  
Bone Lever  
★ ZT590R 350×23, 弯, 髌关节



骨撬  
Bone Lever  
ZT570R 325×34, 弯, 髌关节



骨撬  
Bone Lever  
★ ZT562R 带齿, 205×18



双齿骨撬  
Bone Lever  
★ ZQ584R 300

④ 单齿髌臼骨撬  
Bone Lever



骨撬  
Bone Lever  
★ ZQ581R 280×28



骨撬  
Bone Lever  
★ ZT546R 335×26, 弯

框架自动拉钩 (髌关节自动拉钩)  
Retractor

★ ZT556R 285×248



关节微创牵开器  
Joint Retractor

ZV561R GWQ-I型  
框架 200×200  
拉钩 180×12×22  
180×24×40  
190×24×55  
190×24×70  
190×24×85  
190×24×100

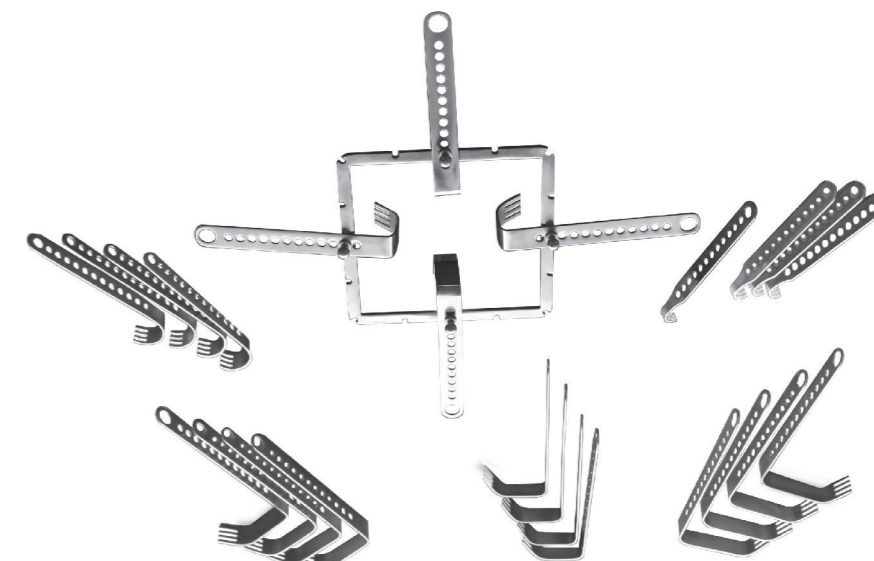

膝关节置换骨撬  
Total Knee Arthroplasty(TKA) Bone L ever

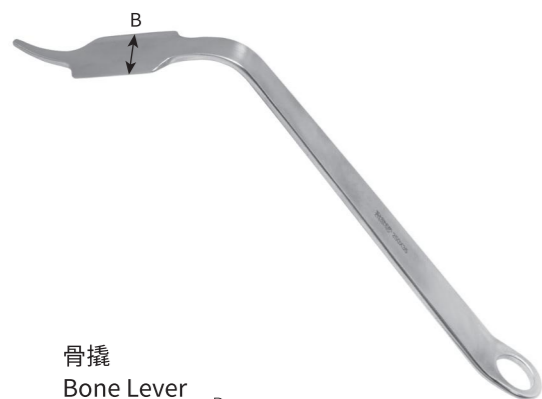

骨撬  
Bone Lever  
★ ZT814R 250x35, 弯  
ZT815R 250x25, 弯



骨撬  
Bone Lever  
ZT584R 150x11, 弯, Z型膝关节拉钩

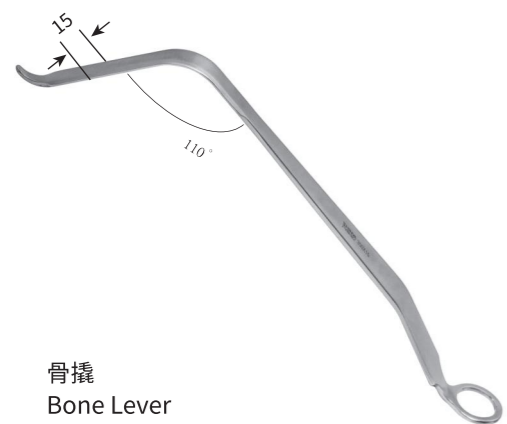

骨撬  
Bone Lever  
ZT816R 300x15, 弯

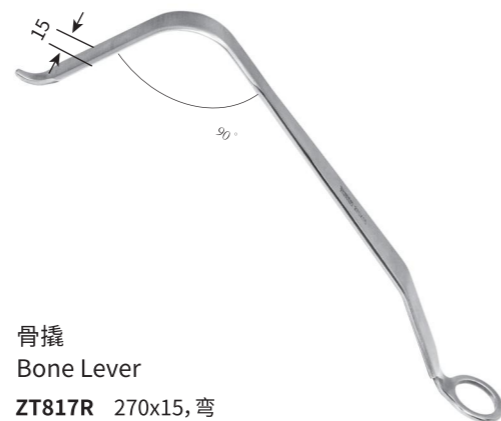

骨撬  
Bone Lever  
ZT817R 270x15, 弯

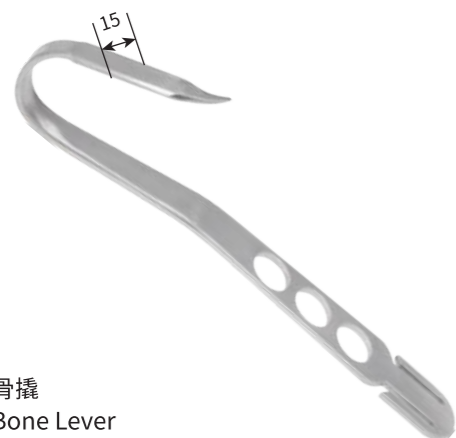

骨撬  
Bone Lever  
★ ZT832R 245x15, 弯

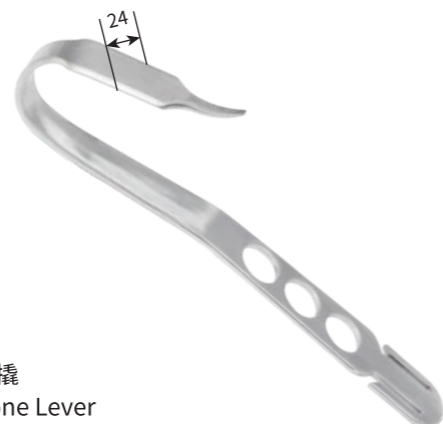

骨撬  
Bone Lever  
★ ZT831R 245x24, 弯



骨撬  
Bone Lever  
★ ZT587R 190x17, 弯, 膝关节股骨前拉钩

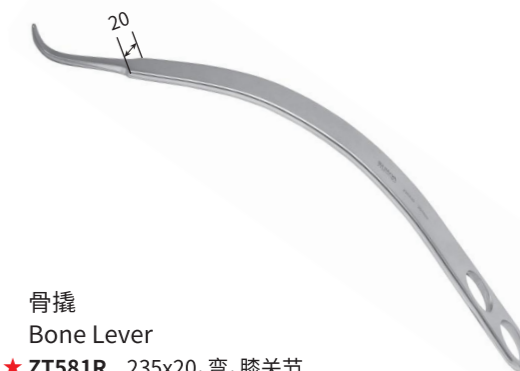

骨撬  
Bone Lever  
★ ZT581R 235x20, 弯, 膝关节

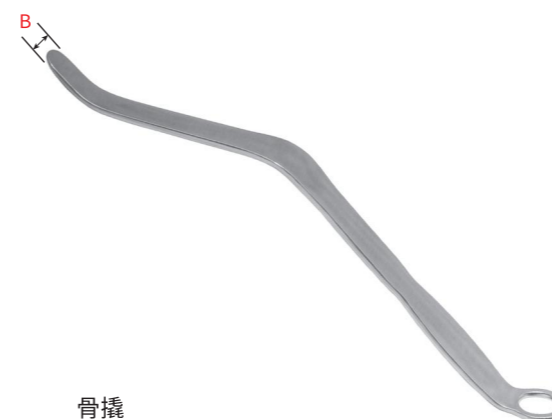

骨撬  
Bone Lever  
ZT577R 220x14, 大, 凹型膝关节拉钩  
ZT578R 220x8, 小, 凹型膝关节拉钩



骨撬  
Bone Lever  
★ ZT580R 230x20, 弯, 膝关节二齿侧副韧带拉钩



骨撬  
Bone Lever  
★ ZT579R 230x20, 弯, 膝关节单齿侧副韧带拉钩



骨撬  
Bone Lever  
★ ZT594R 170x21, 弯



骨撬  
Bone Lever  
★ ZT569R 260x24, 双齿, PCL拉钩

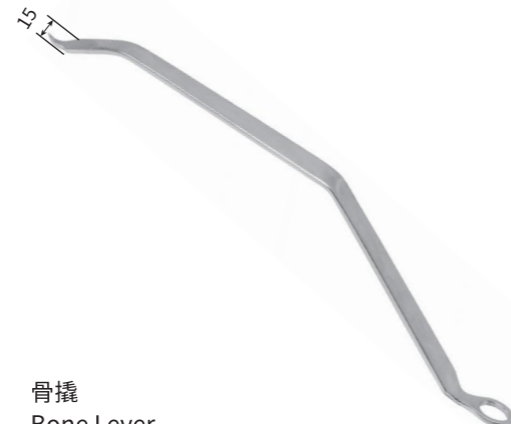

骨撬  
Bone Lever  
★ ZT568R 310x15, 弯, 膝关节后韧带拉钩



骨撬 (骨盆复位)  
Bone Lever  
ZT823R 255x22, 弯, 平头



关节盂拉钩  
Glenoid hook  
ZT844R 285x23, 弯

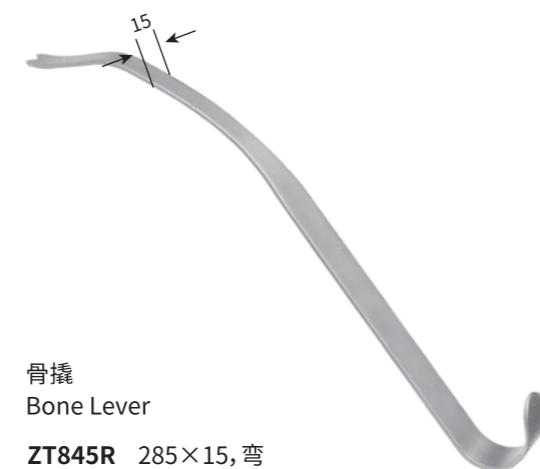

骨撬  
Bone Lever  
ZT845R 285x15, 弯

骨撬  
Bone Lever



★ ZQ648R 230x10

骨撬 (胶木柄)  
Bone Lever



无齿



ZQ586R 330

有齿



ZQ587R 330

胫骨牵开器 (骨撬)  
Tibia Retractor



★ ZQ866R 胫骨牵开器 (骨撬)

骨刀  
Chisel



★ ZQ3601RN 280x8, 直  
★ ZQ3602RN 280x10, 直  
★ ZQ3603RN 280x15, 直  
ZQ3604RN 280x20, 直

★ ZQ3605RN 280x10, 弯  
★ ZQ3606RN 280x15, 弯  
ZQ3607RN 280x20, 弯

骨刀  
Chisel



★ ZQ3608RN 320×15, 弯, 双肩

★ ZQ3609RN 320×20, 弯, 双肩

测深器  
Depth Gauge



ZQ3610RN 190

显微钩  
Microscopic Hook



ZQ3611RN 280×10×φ1

骨科复位钳  
Reposition Forceps



★ ZQ3612RN 200×90, 带尖

骨科用撑开钳  
Distractor



ZQ3613RN 260×11

ZQ3614RN 260×8

打入器  
Impactor



ZQ3615RN 220

骨膜剥离器  
Periosteal Raspator



ZQ3616RN 270×14, 锐口  
Sharp

★ ZQ3618RN 270×14, 钝口  
Blun

骨膜剥离器  
Periosteal Raspator



★ ZQ3619RN 330×8

骨膜剥离器  
Periosteal Raspatory



ZQ3620RN 280×13, 锐口  
Sharp

★ ZQ3621RN 280×13, 钝口  
Blun

骨膜剥离器  
Periosteal Raspatory



ZQ3617RN 185×8, 弯

骨膜剥离器  
Periosteal Raspatory

★ ZQ3622RN 195×4, 双头



咬骨钳  
Bone Rongeur



ZK643R 180×3, 弯, 单关节

咬骨钳  
Bone Rongeur



ZK587R 240×4, 直头, 双关节

骨撬  
Bone Lever

ZT901RN 220×18, 弯



骨撬  
Bone Lever

ZT902RN 300×15, 弯



骨撬  
Bone Lever

★ ZT903RN 265×21, 弯



骨撬  
Bone Lever

★ ZT904RN 270×21, 弯



骨撬  
Bone Lever

ZT905RN 280×21, 弯





JG- II 髋关节截骨手术器械(ZQ3600)  
JG-II Periacetabular osteotomy(PAO) surgical instruments set

序号	产品编码	产品名称	规格型号	数量	单位
1	ZQ3601RN	骨刀	280×8,直	1	把
2	ZQ3602RN	骨刀	280×10,直	1	把
3	ZQ3603RN	骨刀	280×15,直	1	把
4	ZQ3604RN	骨刀	280×20,直	1	把
5	ZQ3605RN	骨刀	280×10,弯	1	把
6	ZQ3606RN	骨刀	280×15,弯	1	把
7	ZQ3607RN	骨刀	280×20,弯	1	把
8	ZQ3608RN	骨刀	320×15,弯,双肩	1	把
9	ZQ3609RN	骨刀	320×20,弯,双肩	1	把
10	ZQ3610RN	测深器	190	1	把
11	ZQ3611RN	显微钩	280×10×φ1	1	把
12	ZQ3612RN	骨科复位钳	200×90,带尖	2	把
13	ZQ3613RN	骨科用撑开钳	260×11	1	把
14	ZQ3614RN	骨科用撑开钳	260×8	1	把
15	ZQ3615RN	打入器	220	1	把
16	ZQ3616RN	骨膜剥离器	270×14,锐口	1	把
17	ZQ3617RN	骨膜剥离器	185×8,弯	1	把
18	ZQ3618RN	骨膜剥离器	270×14,钝口	2	把
19	ZQ3619RN	骨膜剥离器	330×8	1	把
20	ZQ3620RN	骨膜剥离器	280×13,锐口	1	把
21	ZQ3621RN	骨膜剥离器	280×13,钝口	1	把
22	ZQ3622RN	骨膜剥离器	195×4,双头	1	把
23	ZK643R	咬骨钳	180×3,弯,单关节	1	把
24	ZK587R	咬骨钳	240×4,直头,双关节	1	把
25	ZT901RN	骨撬	220×18,弯	2	件
26	ZT902RN	骨撬	300×15,弯	1	件
27	ZT903RN	骨撬	265×21,弯	2	件
28	ZT904RN	骨撬	270×21,弯	1	件
29	ZT905RN	骨撬	280×21,弯	1	件

截骨刀  
Chisel



- ★ ZQ3401RN 240×10
- ★ ZQ3402RN 240×15
- ★ ZQ3403RN 240×20
- ZQ3404RN 240×25

测深器  
Depth Gauge



ZQ3405RN 120

骨科用撑开钳  
Distractor



ZQ3406RN 180×8

夹持器  
Retainer



ZQ3407RN 170

夹持器  
Retainer

ZQ3408RN 230



测深器  
Depth Gauge

ZQ3409RN 350



测深器  
Depth Gauge

ZQ3410RN 350



测深器  
Depth Gauge

ZQ3411RN 130



快装手柄  
Quick coupling handle

ZQ3412RN 4.0



测深器  
Depth Gauge

ZQ3413RN 120



钻头  
Twist drill

ZQ3414RN  $\phi 4.2 \times 200$



起子  
Screwdriver

ZQ3415RN 90×Sw3.5, 六角, 快装



深部椎板拉钩  
Deep Retractor

- ZQ601R 250 带齿 120x60
- ZQ602R 250 带齿 80x40
- ZQ603R 250 带齿 100x50
- ZQ604R 250 带齿 60x30



半月板钩  
Retractor

- ★ ZQ721R 170x56x10



半月板钩  
Retractor

- ★ ZQ722R 180x40x12



半月板钩  
Retractor

- ★ ZQ723R 230x40x10



皮肤拉钩  
Skin Retractor Blunt

- ★ ZT424R 200x8.5, 两齿, 钝 Two Teeth
- ★ ZT425R 220x10, 两齿, 钝 Two Teeth
- ★ ZT426R 220x17, 三齿, 钝 Three Teeth
- ★ ZT427R 220x24, 四齿, 钝 Four Teeth



拉钩  
Retractor

- ★ ZQ2021R 235, 20x67/13x40, 双头反向



皮肤拉钩  
Skin Retractor Blunt

- 总长X(齿宽)X(钩深)  
L×W(Teeth)×H
- ★ ZQ2017R 220x(42,22)x(85,65)
- ★ ZQ2018R 220x(33,10)x(48,37)



提骨钩  
Bone Retractor

- 总长 X 开口 X 钩深  
L×W×H
- ★ ZQ876R 255x16x12, 小
- ★ ZQ877R 265x25x15, 大
- ★ ZQ870R 260x45
- ★ ZQ871R 270x55



T型提骨钩  
Bone Retractor T-Shape

- ★ ZQ2019R 200x34x24



起子  
Screwdriver



ZQ841R SW3.5,内六方

导钻  
Drill guide



ZK748R 双头, Φ4.5/Φ6.5, 导向器

骨牵引针  
Bone traction needle



ZK878R Φ2.5×250

骨锤  
Bone mallet



ZQ311R 220/450g



JG- I 胫骨截骨手术器械(ZQ3400)  
JG-I High tibial osteotomy(HTO) surgical instruments set

序号	产品编码	产品名称	规格型号	数量	单位
1	ZQ3401RN	截骨刀	240×10	1	把
2	ZQ3402RN	截骨刀	240×15	1	把
3	ZQ3403RN	截骨刀	240×20	1	把
4	ZQ3404RN	截骨刀	240×25	1	把
5	ZQ3405RN	测深器	120	1	件
6	ZQ3406RN	骨科用撑开钳	180×8	1	把
7	ZQ3407RN	夹持器	170	1	件
8	ZQ3408RN	夹持器	230	1	件
9	ZQ3409RN	测深器	350	2	件
10	ZQ3410RN	测深器	350	1	件
11	ZQ3411RN	测深器	130	1	件
12	ZQ3412RN	快装手柄	4.0	1	件
13	ZQ3413RN	测深器	120	1	件
14	ZQ3414RN	骨科钻头	Φ4.2×200	2	件
15	ZQ3415RN	起子	90×Sw3.5,六角,快装	1	把
16	ZQ841R	起子	SW3.5,内六方	1	把
17	ZK748R	导钻	双头,Φ4.5/Φ6.5,导向器	1	把
18	ZK878R	骨牵引针	Φ2.5×250	2	支
19	ZQ311R	骨锤	220/450g	1	把

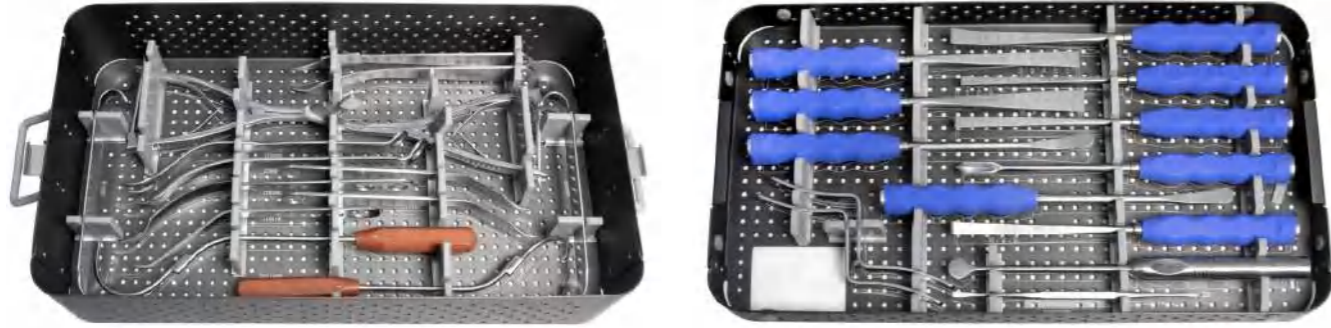

XGJ- I 膝关节器械(ZQ2191)  
XGH-I Knee instruments set(ZQ2191)

序号	产品编码	产品名称	规格型号	数量	单位
1	ZT826R	骨撬	270×20, 弯, 髌关节	1	把
2	ZT584R	骨撬	150×11, 弯	2	把
3	ZT547R	骨撬	240×18	1	把
4	ZT848R	骨撬	280×13, 弯	1	把
5	ZT569R	骨撬	260×24, 双齿	1	把
6	ZT557R	骨撬	弯, 225×5.5	1	把
7	ZT548R	骨撬	235×18	2	把
8	ZT553R	骨撬	240×3, 髌关节	1	把
9	ZQ3601RN	骨刀	280×8, 直	1	把
10	ZQ3602RN	骨刀	280×10, 直	1	把
11	ZQ3603RN	骨刀	280×15, 直	1	把
12	ZQ3604RN	骨刀	280×20, 直	1	把
13	ZQ3605RN	骨刀	280×10, 弯	1	把
14	ZQ3606RN	骨刀	280×15, 弯	1	把
15	ZQ1660R	骨刀	270×10, 直, 圆口, 超薄刃, 圆座型	1	把
16	ZQ1324R	骨科撑开器	230×16, 足踝	2	把
17	ZQ3620RN	骨膜剥离器	280×13, 锐口	1	把
18	ZQ3621RN	骨膜剥离器	280×13, 钝口	1	把
19	ZQ3622RN	骨膜剥离器	195×4, 双头	1	把
20	ZQ552R	骨膜剥离器	280×16, 直, 圆刃, 重切削型	1	把
21	ZQ654R	拉钩	215×60×20, 带齿	1	把
22	ZQ655R	拉钩	215×80×24, 带齿	1	把
23	ZQ1142R	钢丝穿引器	340×45°×70, 空心	1	把
24	ZQ1140R	钢丝穿引器	300×45°×40, 空心	1	把

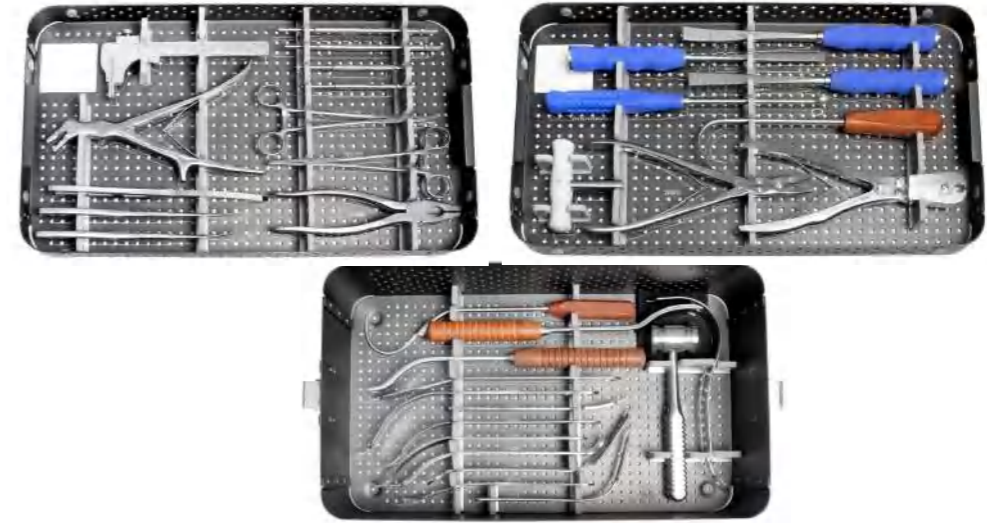

KGJ- I 髌关节器械(ZQ2190)  
KGJ-I Hip instruments set,posterior approach(ZQ2190)

序号	产品编码	产品名称	规格型号	数量	单位
1	ZT849R	骨撬	340×34, 髌关节	1	把
2	ZT827R	骨撬	350×25, 弯, 髌关节, 胶木柄	1	把
3	ZT850R	骨撬	245×28, 弯, 髌关节	1	把
4	ZT840R	骨撬	205×18, 弯	1	把
5	ZT843R	骨撬	260×25, 弯, 髌关节	1	把
6	ZT847R	骨撬	320×32, 弯, 髌关节	1	把
7	ZT846R	骨撬	275×28, 弯, 髌关节	1	把
8	ZT848R	骨撬	280×13, 弯	1	把
9	ZT547R	骨撬	240×18	1	把
10	ZT826R	骨撬	270×20, 弯, 髌关节	1	把
11	ZT553R	骨撬	240×3, 髌关节	1	把
12	ZT560R	骨撬	弯, 310×22	1	把
13	ZQ870R	骨钩	260×45	1	把
14	ZQ1289R	快装手柄	100, T型	1	把
15	ZQ1283R	骨定位针	180, 三角刃	2	把
16	ZQ1285R	骨定位针	130, 三角刃	2	把
17	ZQ3602RN	骨刀	280×10, 直	1	把
18	ZQ3603RN	骨刀	280×15, 直	1	把
19	ZQ3606RN	骨刀	280×15, 弯	1	把
20	ZK970R	咬骨钳	240×4, 直头, 左侧角40°, 双关节	1	把
21	ZK591R	咬骨钳	240×4×20°, 弯头, 双关节	1	把
22	ZQ695R	骨膜剥离器	220×12, 弯, 平刃	1	把
23	ZQ845R	骨膜剥离器	220×15, 弯, 平刃	1	把
24	ZQ1157R	持骨钳	200, 直, 软骨	1	把
25	ZQ1158R	持骨钳	200, 弯, 软骨	1	把
26	ZQ1504R	骨刮匙	300×8, 直, 带齿	1	把
27	ZQ1142R	钢丝穿引器	340×45°×70, 空心	1	把
28	ZQ311R	骨锤	220/450g	1	把
29	ZK268R	骨克丝钳	200×Φ2, 虎头	1	把
30	ZK475R	钢针剪	240×Φ2.5 双刃	1	把
31	ZK964R	医用尺	185	1	把
32	ZK963R	髓腔锉	235	1	把

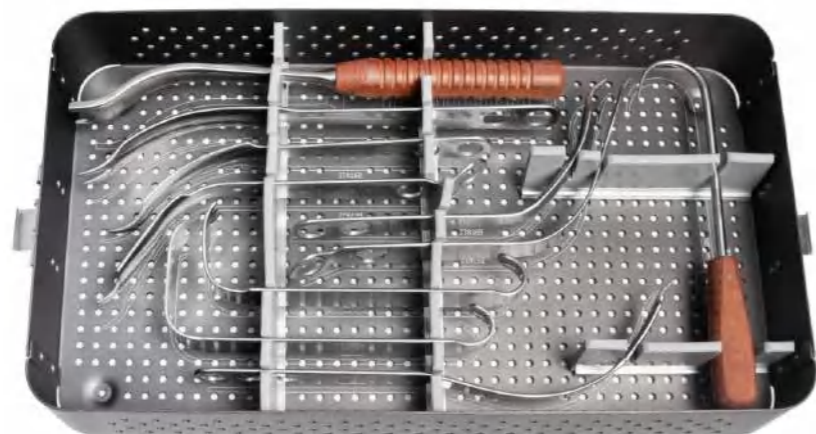

DAA- I 微创髋臼器械(ZQ2192)  
DAA-I MIS hip instruments set,anterior approach(ZQ2192)

序号	产品编码	产品名称	规格型号	数量	单位
1	ZT829R	骨撬	230×27, 弯, 髋关节	1	把
2	ZT830R	骨撬	320×18, 弯, 髋关节	1	把
3	ZT826R	骨撬	270×20, 弯, 髋关节	1	把
4	ZT843R	骨撬	260×25, 弯, 髋关节	1	把
5	ZT836R	骨撬	220×20, 弯, 髋关节	1	把
6	ZQ655R	拉钩	215×80×24, 带齿	1	把
7	ZT827R	骨撬	350×25, 弯, 髋关节, 胶木柄	1	把
8	ZT837R	骨撬	335×25, 弯, 髋关节	1	把
9	ZQ870R	骨钩	260×45	1	把
10	ZQ654R	拉钩	215×60×20, 带齿	1	把

鞍型拉钩  
CASPER Retractor

- ★ ZT466R 250x80x40
- ★ ZT467R 250x70x50
- ★ ZT469R 220x90x40
- ZT502R 220x78x60
- ZT187R 220x103x40



鞍型拉钩  
CASPER Retractor

- ★ ZT468R 270x115x55



拉钩  
Retractor

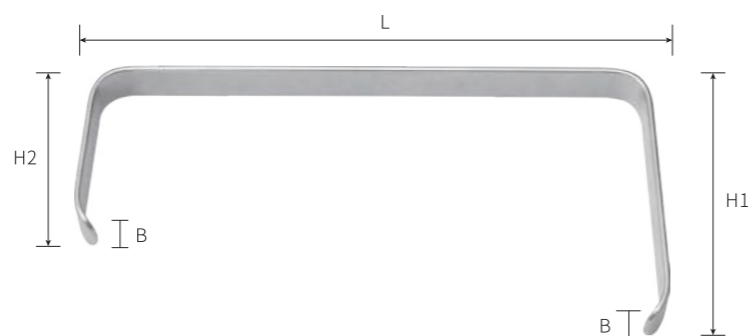

- ★ ZQ654R 215x60x20, 带齿
- ★ ZQ655R 215x80x24, 带齿

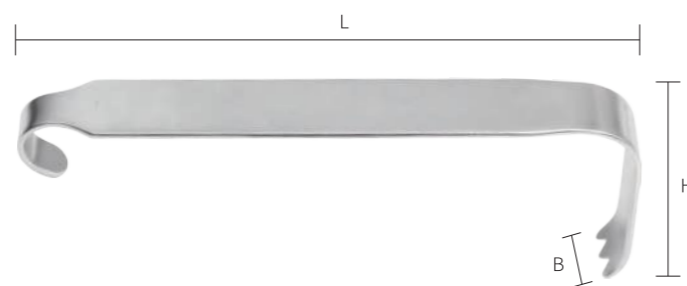

深部骨拉钩  
Retractor

- 注: 拉钩长 X 深 X 宽 (mm)  
Remark: L x D x W
- ★ ZQ605R 250x60x20, 圆
  - ★ ZQ606R 250x80x20, 圆
  - ★ ZQ607R 250x100x30, 圆
  - ★ ZQ608R 250x120x30, 圆
  - ★ ZQ609R 250x140x40, 圆
  - ★ ZQ610R 250x160x40, 圆
  - ZQ611R 250x180x50, 圆
  - ZQ612R 250x200x50, 圆



深部骨拉钩  
Retractor

- 注: 拉钩长 X 深 X 宽 (mm)  
Remark: L x D x W
- ★ ZQ713R 270x60x20, 平
  - ★ ZQ714R 270x80x20, 平
  - ★ ZQ615R 270x100x25, 平
  - ★ ZQ716R 270x120x25, 平
  - ZQ717R 270x140x30, 平
  - ZQ718R 270x160x30, 平
  - ZQ719R 270x180x35, 平
  - ZQ720R 270x200x35, 平



骨拉钩 (胶木柄)  
Retractor

- ★ ZQ649R 235x48x25, 弯
- ★ ZQ650R 235x58x25, 弯
- ZQ651R 235x68x25, 弯



鞍形拉钩  
CASPAR Retractor

- ★ ZT464R 210x55x14
- ★ ZT465R 210x65x17
- ZT470R 210x75x20



直角拉钩  
Retractor

- 注: 拉钩长 X 深 X 宽 (mm)  
Remark: L x D x W
- ★ ZT457R 210x55x14, 单头
  - ★ ZT461R 210x35x14, 单头
  - ★ ZT462R 210x60x20, 单头
  - ★ ZT463R 230x105x30, 单头
  - ★ ZT369R 250x50x30, 单头
  - ★ ZT370R 250x60x40, 单头
  - ★ ZT371R 250x80x45, 单头
  - ★ ZT458R 270x80x25, 单头



直角拉钩  
Retractor

- ZT183R 200x22x5.5



直角拉钩  
Retractor

- ZT190R 235x56x20



直角拉钩  
Retractor

- ★ ZT459R 230x36x20, 单头
- ★ ZT460R 250x67x25, 单头



创口钩  
Retractor, VOLKMANN

- ★ ZT224R 220, 锐, 四爪  
four teeth sharp
- ★ ZT229R 220, 钝, 四爪  
four teeth blunt



创口钩 (肌肉拉钩)  
Retractor, VOLKMANN

- ★ ZT399R 210x35, 扁柄, 三爪, 钝  
three teeth, blunt
- ★ ZT400R 210x35, 扁柄, 四爪, 钝  
four teeth, blunt
- ★ ZT401R 210x45, 扁柄, 三爪, 钝  
three teeth, blunt
- ★ ZT223R 210x45, 扁柄, 四爪, 钝  
four teeth, blunt
- ★ ZT402R 210x55, 扁柄, 三爪, 钝  
three teeth, blunt
- ★ ZT403R 210x55, 扁柄, 四爪, 钝  
four teeth, blunt



深部创口钩 (肌肉拉钩)  
Retractor, VOLKMANN



注: 拉钩长 X 深 X 宽 (mm)  
Remark: L x D x W

- |   |  |  |
|---|--|--|
| ★ ZT405R 250x35x23, 扁柄, 三爪                | ★ ZT411R 250x35x32, 扁柄, 四爪               | ZT417R 250x35x41, 扁柄, 五爪               |
| ★ ZT406R 250x45x23, 扁柄, 三爪                | ★ ZT412R 250x45x32, 扁柄, 四爪               | ZT418R 250x45x41, 扁柄, 五爪               |
| ★ ZT407R 250x55x23, 扁柄, 三爪                | ★ ZT413R 250x55x32, 扁柄, 四爪               | ZT419R 250x55x54, 扁柄, 五爪               |
| ★ ZT408R 250x65x30, 扁柄, 三爪                | ★ ZT414R 250x65x42, 扁柄, 四爪               | ZT420R 250x65x54, 扁柄, 五爪               |
| ★ ZT409R 250x75x30, 扁柄, 三爪                | ★ ZT415R 250x75x42, 扁柄, 四爪               | ZT421R 250x75x54, 扁柄, 五爪               |
| ★ ZT410R 250x85x30, 扁柄, 三爪<br>three teeth | ★ ZT416R 250x85x42, 扁柄, 四爪<br>four teeth | ZT422R 250x85x54, 扁柄, 五爪<br>five teeth |

深部创口钩 (肌肉拉钩)  
Retractor, VOLKMANN



注: 拉钩长 X 深 X 宽 (mm)  
Remark: L x D x W

- |   |  |  |
|---|--|--|
| ZT428R 240x35x23, 圆柄, 三爪                | ZT436R 240x35x32, 圆柄, 四爪                 | ZT437R 240x55x54, 圆柄, 五爪                 |
| ZT432R 240x45x23, 圆柄, 三爪                | ★ ZT440R 240x45x32, 圆柄, 四爪               | ZT438R 240x65x54, 圆柄, 五爪                 |
| ★ ZT429R 240x55x23, 圆柄, 三爪              | ★ ZT433R 240x55x32, 圆柄, 四爪               | ★ ZT439R 240x75x54, 圆柄, 五爪               |
| ★ ZT430R 240x65x30, 圆柄, 三爪              | ★ ZT434R 240x65x42, 圆柄, 四爪               | ★ ZT443R 240x85x54, 圆柄, 五爪<br>five teeth |
| ★ ZT431R 240x75x30, 圆柄, 三爪              | ★ ZT435R 240x75x42, 圆柄, 四爪               |  |
| ZT441R 240x85x30, 圆柄, 三爪<br>three teeth | ★ ZT442R 240x85x42, 圆柄, 四爪<br>four teeth |  |

下肢截断拉钩 (截肢挡板)  
Amputation Retractor

ZQ961R φ130



骨盆拉钩  
Pelvic Retractor

ZQ724R 290x124x60 平  
ZQ727R 330x174x60 平

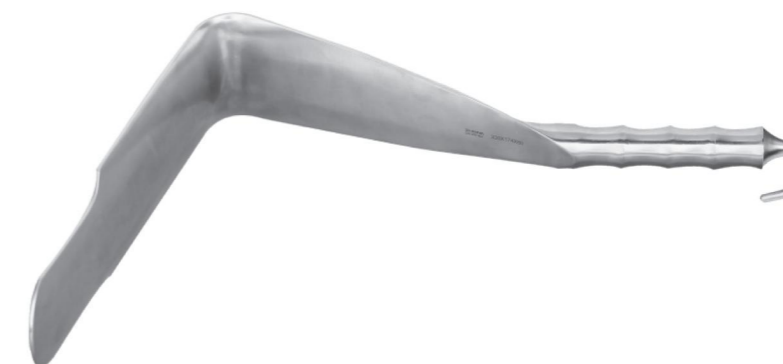

骨盆拉钩  
Pelvic Retractor

ZQ725R 290x124x60 弯  
ZQ728R 330x174x60 弯



骨锤  
Bone Mallet

- ★ ZK042R 200/75g
- ★ ZK044R 200/140g



骨锤  
Bone Mallet

- ★ ZQ311R 220/450g



骨锤  
Bone Mallet

- ZQ317R 230/270g



骨锤  
Bone Mallet

- ★ ZQ312R 220/270g
- ★ ZQ314R 250/500g
- ★ ZQ300R 250/600g
- ★ ZQ315R 250/750g
- ZQ316R 250/1000g



骨锤  
Bone Mallet

- ZQ301R 250/290g, 硬平头  
hard flat sides
- ZQ302R 250/375g, 硬球头  
hard round sides
- ZQ303R 250/295g, 硬球平头  
hard round flat sides

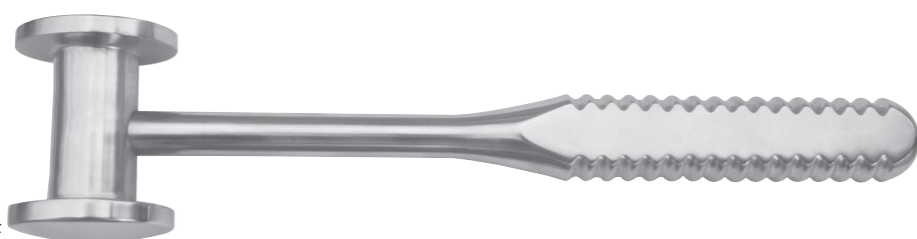

骨锤  
Bone Mallet

- ZQ304R 250/380g, 软平头  
soft flat sides
- ZQ305R 250/380g, 软球头  
soft round sides
- ZQ306R 250/380g, 软球平头  
soft round flat sides



骨锤  
Bone Mallet

- ZQ307R 250/450g, 软硬平头  
soft hard flat sides
- ZQ308R 250/470g, 软硬球头  
soft hard round sides
- ZQ309R 250/470g, 软球硬平头  
soft round hard flat sides
- ZQ310R 250/470g, 软平硬球头  
soft flat hard round sides

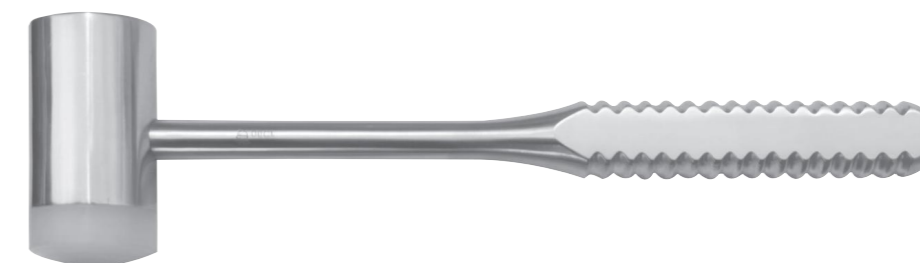

骨锤  
Bone Mallet

- ★ ZK045R 180/50g
- ★ ZK046R 180/70g



骨锤  
Bone Mallet

- ★ ZQ297R 230/250g



锤骨器  
Bone impactor

- ★ ZQ924RN 210xΦ8
- ★ ZQ925RN 210xΦ10
- ★ ZQ926RN 210xΦ13



植骨器  
Bone grafting impactor

- ★ ZQ999R 260×φ6
- ★ ZQ1000R 260×φ8
- ★ ZQ1001R 260×φ10
- ★ ZQ1002R 260×φ12



植骨器  
Bone grafting impactor

- ★ ZQ1003R 250×φ6
- ★ ZQ1004R 250×φ8
- ★ ZQ1005R 250×φ10
- ★ ZQ1006R 250×φ12



植骨器  
Bone grafting impactor

- ZQ1007R 260×6×8
- ZQ1008R 260×8×10
- ZQ1009R 260×10×12



植骨打入器  
Bone Grafting Impactor

- ★ ZQ1322R 220x15x10, 滚花柄



指骨挫  
Bone File

- ★ ZK502R 190, 直 straight
- ★ ZK509R 190, 弯 curved



双头骨挫  
Bone File

- “#”越大, 纹路越细 bigger No. means finer serration.
- ZK448R 200, 1#
  - ★ ZK449R 200, 2#
  - ZK477R 200, 3#
  - ★ ZK450R 200, 4#
  - ★ ZK451R 200, 5#



单头骨挫  
Bone File

“#”越大, 纹路越粗 bigger No. means coarser serration.

- ★ ZK452R 220, 1#
- ★ ZK453R 220, 2#
- ★ ZK454R 220, 3#



骨挫  
Bone File

- ★ ZK511R 250



截断刀  
Amputation Knife

- ★ ZB150R 300



指骨锯 (圆柄)  
Bone Saw

- ★ ZK444R 180



指骨锯 (扁柄)  
Bone Saw

- ZK445R 230



石膏锯  
Plaster Saw

- ★ ZK446R 205



手部骨锯  
Hand Bone Saw

★ ZK302R 210  
ZK303R 锯条 blade

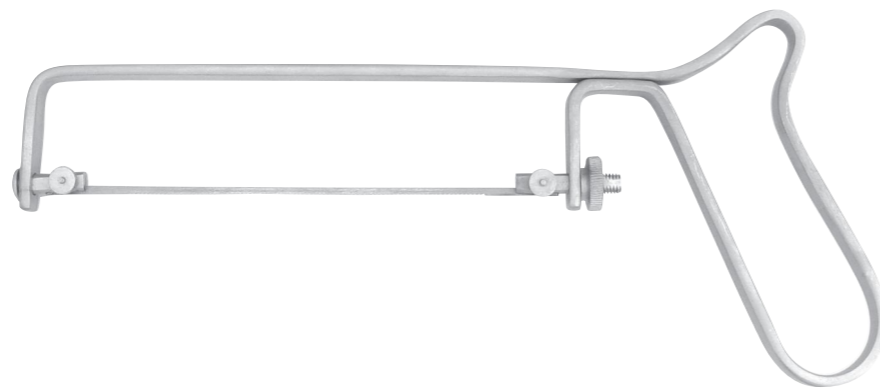

弓锯  
Bone Saw

★ ZK300R 300  
ZK301C 锯条 blade



板型骨锯  
BoneSaw

★ ZK447R 320



紧丝钳  
Wire Tightening Forceps

★ ZK271R 紧丝钳



扎丝钳  
Wire Tightening Forceps

★ ZK272R 245



钢丝缠绕器  
Wire Twister

ZK277R 255



股骨撑开器  
Femoral Spreader

★ ZQ235R II型, 全长430



股骨撑开器  
Femoral Spreader

★ ZQ236R I型, 全长350



斯式牵引器 (弓)  
Steinmann Traction Bow

- ★ ZQ873R 小号 255x130
- ★ ZQ874R 中号 300x155
- ★ ZQ875R 大号 330x180

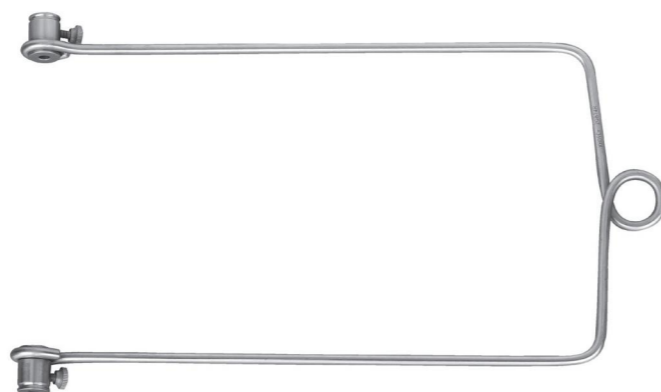

钢针固定牵引器  
Pin Fixation Retractor

- ★ ZK197R 大号 最大开口 180  
max. opening 180
- ★ ZK198R 小号 最大开口 135  
max. opening 135



颅骨牵引器  
Cranial Retractor

- ★ ZF130R I型, 小号 最大开口 125  
max. opening 125
- ★ ZF133R I型, 大号 最大开口 135  
max. opening 135



颅骨牵引器  
Cranial Retractor

- ★ ZF132R II型 最大开口 250  
max. opening 250

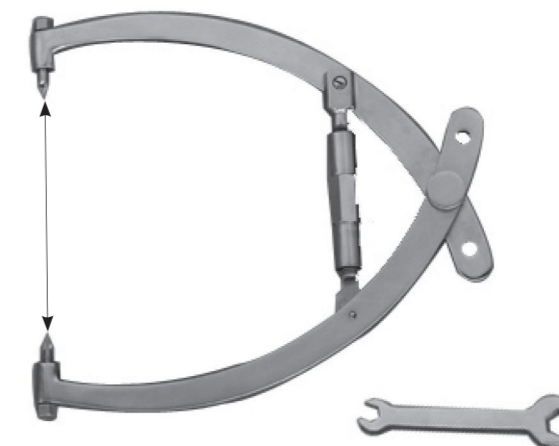

颅骨牵引器  
Cranial Retractor

- ★ ZF134R III型, 最大开口 160  
max. opening 160

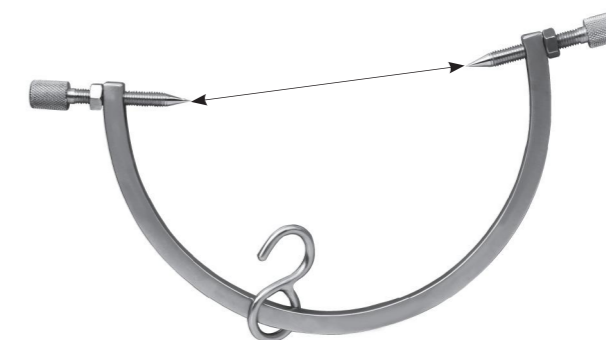

颅骨牵引器  
Cranial Retractor

- ★ ZK196R 钻孔定位, 配  $\phi 3.5$  钻头 9 个  
including 9pcs  $\phi 3.5$ mm drills



钢丝引导器 (导丝器)  
Wire Guide



- ZQ1136R 250x30°x20
- ★ ZQ1137R 250x30°x25
- ZQ1138R 250x30°x30
- ★ ZQ1139R 250x30°x35

钢丝引导器 (导丝器)  
Wire Guide



- ★ ZQ1148R 250xR23x48, 左弯 left curved
- ★ ZQ1149R 250xR23x48, 右弯 right curved
- ZQ1150R 250xR23x48, 直型 straight

空心钢丝引导器  
Cannulated Wire Guide



- ZQ1151R 225xR22x35, 直型 straight
  - ★ ZQ1152R 240xR30x50, 直型 straight
  - ★ ZQ1153R 240xR30x60, 左弯 left curved
  - ZQ1154R 240xR22x45, 左弯 left curved
  - ★ ZQ1134R 240xR30x60, 右弯 right curved
  - ZQ1135R 240xR22x45, 右弯 right curved
- 注: 内径φ2mm inner dia. φ2mm

钢丝穿引器  
Wire Guide



- ★ ZQ1159R 303x48, 大号
  - ★ ZQ1160R 258x39, 小号
- 注: 内径φ2mm inner dia. φ2mm

角度尺  
Angle Gauge

ZQ2023R 调整范围90°-180°



角度尺  
Angle Gauge

ZQ2024R 95°



角度尺  
Angle Gauge

ZQ2025R 130°



钢丝引导器 (导丝器)  
wire Guide

- ★ZQ1140R 300×45°×40, 空心
- ★ZQ1141R 320×45°×55, 空心
- ★ZQ1142R 340×45°×70, 空心



快装手柄  
Handle, T-shape

ZQ1289R 100, T型



骨定位针  
Guiding Pin

- ZQ1283R 180, 三角刃
- ZQ1285R 130, 三角刃



医用尺  
Medical ruler

ZK964R 185

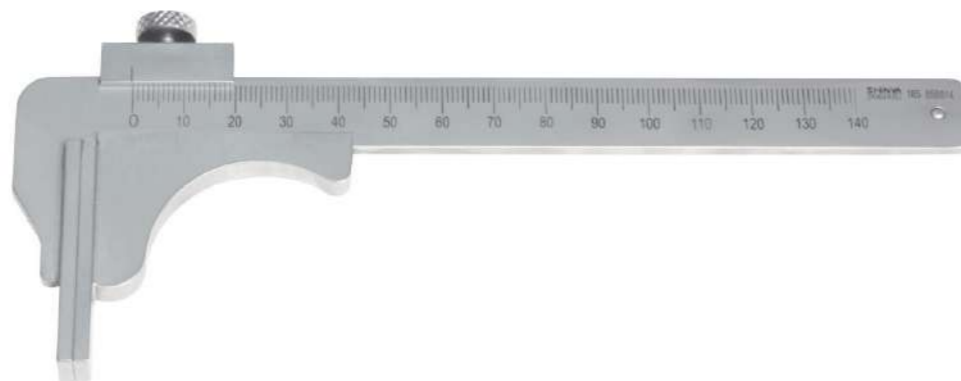

髓腔锉  
medullary file

ZK963R 235



骨撬  
Bone Lever

- |        |     |    |        |
|--------|-----|----|--------|
|        | L   | B  |        |
| ZT850R | 245 | 28 | 弯, 髋关节 |
| ZT851R | 245 | 23 | 弯, 髋关节 |



植骨器  
Bone grafting impactor

- ZQ1411R 260×φ6
- ZQ1413R 260×φ10

- ZQ1412R 260×φ8
- ZQ1414R 260×φ12



石膏剪  
Plastic Shear  
LS758R 直柄



布朗式牵引架  
Blouse Tracting Rack  
★ ZV750R 布朗式牵引架

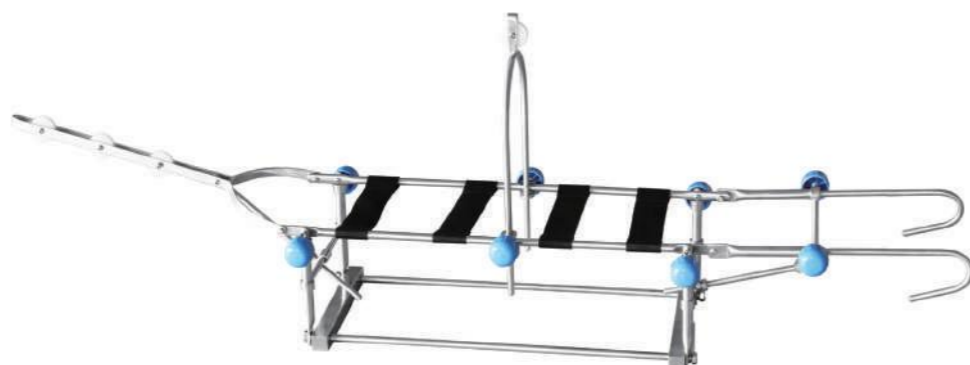

床头牵引架  
Bedhead Tracting Rack  
★ ZV751R

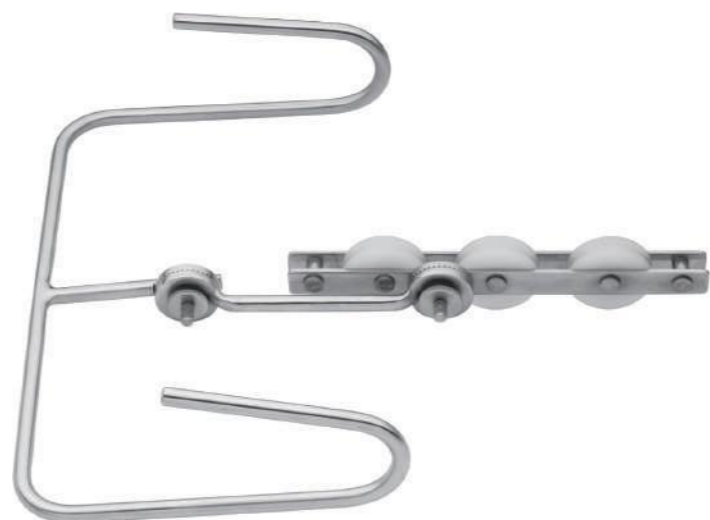

坐骨神经牵开器  
Sciatic Nerve Retractor  
ZQ627R 310x30



软钻导向器 (钢板导钻)  
Plate Guide  
ZK757R 适用范围  $\phi 2.5-\phi 4$   
for  $\phi 2.5-\phi 4$



X 射线摄影尺  
X Ray Photography Ruler  
★ ZA807R 200 ★ ZA809R 400  
★ ZA808R 300



C 形导钻 (套)  
Guide, C-shape, set

frame wire guide  
ZK733R 1# (35x $\phi 6$  导钻架,  $\phi 2.5, \phi 3.5$  导钻头)  
ZK734R 2# (42x $\phi 6$  导钻架,  $\phi 3.2, \phi 4.5$  导钻头)  
ZK735R 3# (42x $\phi 8$  导钻架,  $\phi 6.5$  导钻头)



打孔器  
Punch  
ZK428R 股骨 for femur  
ZK429R 胫骨 for tibia



麻花钻头 (骨钻)  
Twist Drill

ZK886R	100xΦ0.8	★ ZK890R	115xΦ2	★ ZK891R	115xΦ4.5	ZQ3414RN	Φ4.2×200
ZK887R	100xΦ1	★ ZK893R	115xΦ2.5	★ ZK718R	150xΦ2.5		
ZK888R	100xΦ1.2	★ ZK892R	115xΦ2.8	★ ZK713R	150xΦ2.7		
ZK730R	100xΦ1.5	ZK894R	115xΦ3	★ ZK714R	150xΦ3.2		
ZK731R	100xΦ1.8	★ ZK895R	115xΦ3.2	★ ZK712R	150xΦ3.5		
ZK732R	100xΦ2	★ ZK897R	115xΦ3.5	★ ZK715R	150xΦ4		
ZK889R	115xΦ1.6	★ ZK898R	115xΦ4	★ ZK716R	150xΦ4.5		



空心钻 (丁字手柄)  
Bone Trepine(T handle)

★ ZK865R	Φ4	★ ZK862R	Φ8
★ ZK867R	Φ5	★ ZQ857R	Φ10
★ ZK861R	Φ7	★ ZK863R	Φ12



丝锥  
Screw Tap

★ ZQ849R	HA2	ZQ852R	HA3.5
ZQ850R	HA2.7	ZQ853R	HA4.5
ZQ851R	HA3	★ ZQ899R	HB4
		ZQ855R	HB6.5



埋头钻  
Drill

LS023R	Φ6
LS024R	Φ8



导向器 (护套, 钻套)  
Guide Double Ended

★ ZK745R	双头, Φ2.5/Φ3.5
★ ZK746R	双头, Φ3.2/Φ4.0
★ ZK747R	双头, Φ3.2/Φ4.5
★ ZK748R	双头, Φ4.5/Φ6.5



骨科钻头 (软管钻)  
Flexible Drill

ZK725R	Φ2.5, 软管钻, 分体型
ZK726R	Φ3.2, 软管钻, 分体型
ZK727R	Φ3.5, 软管钻, 分体型
ZK729R	Φ4.5, 软管钻, 分体型



双头导钻 (插入导钻)  
Guide

LS325R	Φ2.5
LS033R	Φ3.2



断钉取出器 (断螺钉拔出器)  
Remover Of Broken Bone Screws

★ ZQ872R	HA3.5
★ ZQ898R	HA4.5
★ ZQ903R	HA6.5



螺钉打滑器  
Screw Tap

★ ZQ900R	SW2.5
★ ZQ901R	SW3.5



螺钉夹持器 (镊)  
Screw Holding Forceps

★ ZQ902R	HA3.5-4.5
ZQ907R	HA2.0



螺钉夹持钳  
Screw Holding Forceps

★ ZQ906R	HA2.0
----------	-------



髓腔铰刀  
Cannulated Reamer For Medullary Cave, malleable



ZQ762R Φ8 ZQ764R Φ10 ZQ766R Φ12  
ZQ763R Φ9 ZQ765R Φ11

髓腔铰刀  
Reamer For Medullary Cave



ZQ2066R Φ8, 硬杆 ZQ2068R Φ10, 硬杆 ZQ2070R Φ12, 硬杆  
ZQ2067R Φ9, 硬杆 ZQ2069R Φ11, 硬杆

探测器  
Depth gauge



★ ZQ613R 60 ★ ZQ249R 30  
★ LS004R 90 ★ ZQ3413RN 120

手摇骨钻  
Bunnell Hand Drill

★ ZK005R 夹持Φ0.4-4mm钻头  
for 0.4-4mm drill



手摇骨钻  
Bunnell Hand Drill

★ ZK006R 夹持Φ6以下钻头  
for drill less than 6mm

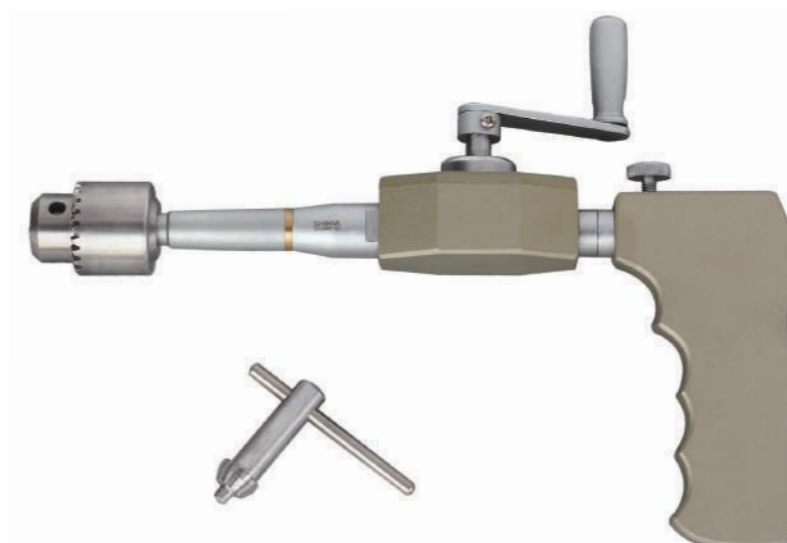

金属骨针  
Sterile Kirshner pin



注:常用规格如下

ZY080800401S	锥刃圆型Φ0.8×80无菌	ZY202800401S	锥刃圆型Φ2×280无菌
ZY081000401S	锥刃圆型Φ0.8×100无菌	ZY203000401S	锥刃圆型Φ2×300无菌
ZY081200401S	锥刃圆型Φ0.8×120无菌	ZY252300401S	锥刃圆型Φ2.5×230无菌
ZY082300401S	锥刃圆型Φ0.8×230无菌	ZY252500401S	锥刃圆型Φ2.5×250无菌
ZY082500401S	锥刃圆型Φ0.8×250无菌	ZY252800401S	锥刃圆型Φ2.5×280无菌
ZY082800401S	锥刃圆型Φ0.8×280无菌	ZY253000401S	锥刃圆型Φ2.5×300无菌
ZY083000401S	锥刃圆型Φ0.8×300无菌	ZY302300401S	锥刃圆型Φ3×230无菌
ZY100800401S	锥刃圆型Φ1×80无菌	ZY302500401S	锥刃圆型Φ3×250无菌
ZY101000401S	锥刃圆型Φ1×100无菌	ZY302800401S	锥刃圆型Φ3×280无菌
ZY101200401S	锥刃圆型Φ1×120无菌	ZY303000401S	锥刃圆型Φ3×300无菌
ZY102300401S	锥刃圆型Φ1×230无菌	ZY352300401S	锥刃圆型Φ3.5×230无菌
ZY102500401S	锥刃圆型Φ1×250无菌	ZY352500401S	锥刃圆型Φ3.5×250无菌
ZY102800401S	锥刃圆型Φ1×280无菌	ZY352800401S	锥刃圆型Φ3.5×280无菌
ZY103000401S	锥刃圆型Φ1×300无菌	ZY353000401S	锥刃圆型Φ3.5×300无菌
ZY120800401S	锥刃圆型Φ1.2×80无菌	ZY402300401S	锥刃圆型Φ4×230无菌
ZY121000401S	锥刃圆型Φ1.2×100无菌	ZY402500401S	锥刃圆型Φ4×250无菌
ZY121200401S	锥刃圆型Φ1.2×120无菌	ZY402800401S	锥刃圆型Φ4×280无菌
ZY122300401S	锥刃圆型Φ1.2×230无菌	ZY403000401S	锥刃圆型Φ4×300无菌
ZY122500401S	锥刃圆型Φ1.2×250无菌	ZY452300401S	锥刃圆型Φ4.5×230无菌
ZY122800401S	锥刃圆型Φ1.2×280无菌	ZY452500401S	锥刃圆型Φ4.5×250无菌
ZY123000401S	锥刃圆型Φ1.2×300无菌	ZY452800401S	锥刃圆型Φ4.5×280无菌
ZY152300401S	锥刃圆型Φ1.5×230无菌	ZY453000401S	锥刃圆型Φ4.5×300无菌
ZY152500401S	锥刃圆型Φ1.5×250无菌	ZY502300401S	锥刃圆型Φ5×230无菌
ZY152800401S	锥刃圆型Φ1.5×280无菌	ZY502500401S	锥刃圆型Φ5×250无菌
ZY153000401S	锥刃圆型Φ1.5×300无菌	ZY502800401S	锥刃圆型Φ5×280无菌
ZY202300401S	锥刃圆型Φ2×230无菌	ZY503000401S	锥刃圆型Φ5×300无菌
ZY202500401S	锥刃圆型Φ2×250无菌		

金属骨针  
Sterile Kirschner pin, anodized



注:常用规格如下

- ZY080800401P 锥刃圆型Φ0.8×80阳极氧化 无菌
- ZY081000401P 锥刃圆型Φ0.8×100阳极氧化 无菌
- ZY081200401P 锥刃圆型Φ0.8×120阳极氧化 无菌
- ZY082300401P 锥刃圆型Φ0.8×230阳极氧化 无菌
- ZY082500401P 锥刃圆型Φ0.8×250阳极氧化 无菌
- ZY082800401P 锥刃圆型Φ0.8×280阳极氧化 无菌
- ZY083000401P 锥刃圆型Φ0.8×300阳极氧化 无菌
- ZY100800401P 锥刃圆型Φ1×80阳极氧化 无菌
- ZY101000401P 锥刃圆型Φ1×100阳极氧化 无菌
- ZY101200401P 锥刃圆型Φ1×120阳极氧化 无菌
- ZY102300401P 锥刃圆型Φ1×230阳极氧化 无菌
- ZY102500401P 锥刃圆型Φ1×250阳极氧化 无菌
- ZY102800401P 锥刃圆型Φ1×280阳极氧化 无菌
- ZY103000401P 锥刃圆型Φ1×300阳极氧化 无菌
- ZY120800401P 锥刃圆型Φ1.2×80阳极氧化 无菌
- ZY121000401P 锥刃圆型Φ1.2×100阳极氧化 无菌
- ZY121200401P 锥刃圆型Φ1.2×120阳极氧化 无菌
- ZY122300401P 锥刃圆型Φ1.2×230阳极氧化 无菌
- ZY122500401P 锥刃圆型Φ1.2×250阳极氧化 无菌
- ZY122800401P 锥刃圆型Φ1.2×280阳极氧化 无菌
- ZY123000401P 锥刃圆型Φ1.2×300阳极氧化 无菌
- ZY152300401P 锥刃圆型Φ1.5×230阳极氧化 无菌
- ZY152500401P 锥刃圆型Φ1.5×250阳极氧化 无菌
- ZY152800401P 锥刃圆型Φ1.5×280阳极氧化 无菌
- ZY153000401P 锥刃圆型Φ1.5×300阳极氧化 无菌
- ZY202300401P 锥刃圆型Φ2×230阳极氧化 无菌
- ZY202500401P 锥刃圆型Φ2×250阳极氧化 无菌

- ZY202800401P 锥刃圆型Φ2×280阳极氧化 无菌
- ZY203000401P 锥刃圆型Φ2×300阳极氧化 无菌
- ZY252300401P 锥刃圆型Φ2.5×230阳极氧化 无菌
- ZY252500401P 锥刃圆型Φ2.5×250阳极氧化 无菌
- ZY252800401P 锥刃圆型Φ2.5×280阳极氧化 无菌
- ZY253000401P 锥刃圆型Φ2.5×300阳极氧化 无菌
- ZY302300401P 锥刃圆型Φ3×230阳极氧化 无菌
- ZY302500401P 锥刃圆型Φ3×250阳极氧化 无菌
- ZY302800401P 锥刃圆型Φ3×280阳极氧化 无菌
- ZY303000401P 锥刃圆型Φ3×300阳极氧化 无菌
- ZY352300401P 锥刃圆型Φ3.5×230阳极氧化 无菌
- ZY352500401P 锥刃圆型Φ3.5×250阳极氧化 无菌
- ZY352800401P 锥刃圆型Φ3.5×280阳极氧化 无菌
- ZY353000401P 锥刃圆型Φ3.5×300阳极氧化 无菌
- ZY402300401P 锥刃圆型Φ4×230阳极氧化 无菌
- ZY402500401P 锥刃圆型Φ4×250阳极氧化 无菌
- ZY402800401P 锥刃圆型Φ4×280阳极氧化 无菌
- ZY403000401P 锥刃圆型Φ4×300阳极氧化 无菌
- ZY452300401P 锥刃圆型Φ4.5×230阳极氧化 无菌
- ZY452500401P 锥刃圆型Φ4.5×250阳极氧化 无菌
- ZY452800401P 锥刃圆型Φ4.5×280阳极氧化 无菌
- ZY453000401P 锥刃圆型Φ4.5×300阳极氧化 无菌
- ZY502300401P 锥刃圆型Φ5×230阳极氧化 无菌
- ZY502500401P 锥刃圆型Φ5×250阳极氧化 无菌
- ZY502800401P 锥刃圆型Φ5×280阳极氧化 无菌
- ZY503000401P 锥刃圆型Φ5×300阳极氧化 无菌

骨牵引针  
Kirshner pin

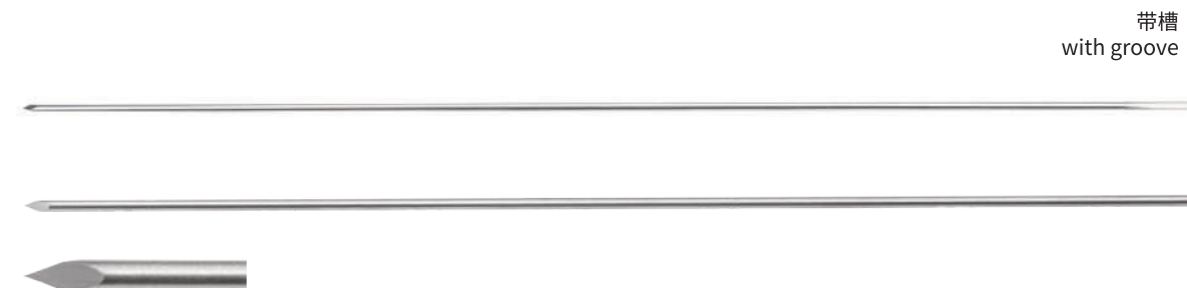

- ZK994R Φ4×300
- ZK947R Φ4×280
- ZK885R Φ4×250
- ZK874R Φ4×230
- ★ ZK948R Φ3×300
- ★ ZK945R Φ3×280
- ★ ZK883R Φ3×250
- ★ ZK873R Φ3×230
- ★ ZK949R Φ3.5×300
- ★ ZK946R Φ3.5×280
- ★ ZK884R Φ3.5×250
- ★ ZK875R Φ3.5×230
- ★ ZK921R Φ2×300
- ★ ZK943R Φ2×280
- ★ ZK882R Φ2×250
- ★ ZK870R Φ2×230
- ★ ZK922R Φ2.5×300
- ★ ZK944R Φ2.5×280
- ★ ZK878R Φ2.5×250

- ★ ZK872R Φ2.5×230
- ZK871R Φ2.3×380, 带槽 with groove
- ZK939R Φ2.3×230, 带槽 with groove
- ZK919R Φ1×300
- ZK940R Φ1×280
- ZK876R Φ1×250
- ZK868R Φ1×230
- ZK880R Φ1×180
- ZK881R Φ1×120
- ZK920R Φ1.5×300
- ZK942R Φ1.5×280
- ZK877R Φ1.5×250
- ZK869R Φ1.5×230
- ZK992R Φ1.5×200
- ZK941R Φ1.2×280
- ZK879R Φ1.2×250
- ZK864R Φ1.2×230
- ZK985R Φ0.8×250
- ZK995R Φ1.8×250

- 扎丝  
steel wire
- |          | 规格  | length<br>长度/30g |
|----------|-----|------------------|
| ZQ803R   | 0.3 | 54m              |
| ★ ZQ804R | 0.4 | 30.5m            |
| ★ ZQ805R | 0.5 | 19.5m            |
| ★ ZQ806R | 0.6 | 13.5m            |
| ★ ZQ807R | 0.7 | 10m              |
| ★ ZQ808R | 0.8 | 7.5m             |
| ★ ZQ810R | 1   | 5m               |
| ★ ZQ812R | 1.2 | 3.5m             |





SZG- I 型上肢手术器械 (ZK300)  
SZG-I surgical instruments set for upper limb

序号	编码	名称	规格	单位	数量
1	ZQ852R	丝锥	HA3.5	把	1
2	ZQ899R	丝锥	HB4.0	把	1
3	ZQ900R	螺钉打滑器	SW2.5	把	1
4	LS023R	埋头钻	Φ6	把	1
5	ZK865R	空心钻	Φ4	把	1
6	ZQ902R	螺钉夹持器(钳)	HA3.5 - 4.5	把	1
7	ZQ840R	六角起子(内六角螺丝刀)(内六方改锥)	SW2.5	把	1
8	ZK165R	带尖复位钳	190	把	1
9	ZK164R	复位钳	170,直头	把	1
10	ZK161R	中心化持骨钳(复位钳)	190	把	2
11	ZQ613R	测深器	60	把	1
12	ZK745R	导向器(护套,钻套)	Φ2.5/3.5	把	1
13	ZK746R	导向器(护套,钻套)	Φ3.2/4.0	把	1
14	LS325R	双头导钻(插入导钻)	Φ2.5	把	1
15	ZQ754R	骨撬(牵开器)	240×18,平	把	1
16	ZQ580R	骨撬(牵开器)	240×42,平	把	1
17	ZQ859R	骨板折弯器	左、右,双槽200×3/4,斜口,单头	副	1
18	ZQ767R	骨膜剥离器	180×8圆	把	1
19	ZQ688R	骨膜剥离器	180×12平	把	1
20	ZK893R	骨钻	Φ2.5	支	2
21	ZK895R	骨钻	Φ3.2	支	2

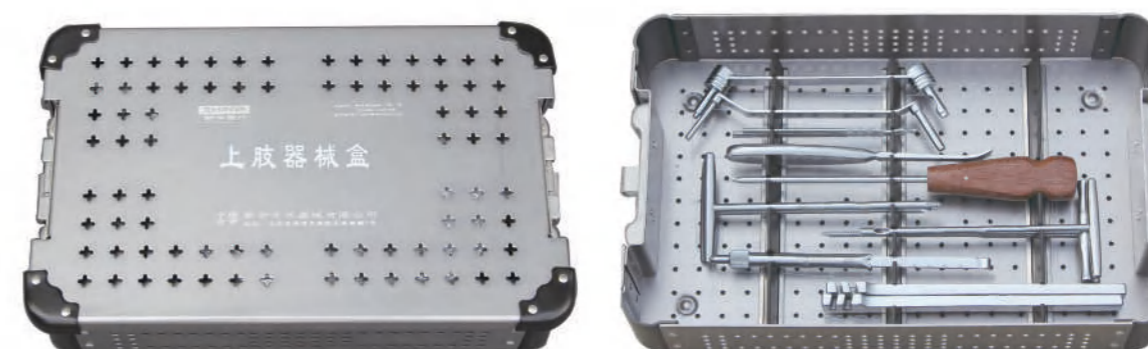

SZG- II 型简易上肢手术器械 (ZK298)  
SZG- II simple surgical instruments set for upper limb

序号	编码	名称	规格	单位	数量
1	ZQ852R	丝锥	HA3.5	把	1
2	ZQ899R	丝锥	HB4.0	把	1
3	ZQ900R	螺钉打滑器	SW2.5	把	1
4	LS023R	埋头钻	Φ6	把	1
5	ZK865R	空心钻	Φ4	把	1
6	ZQ840R	六角起子(内六角螺丝刀)(内六方改锥)	SW2.5	把	1
7	ZQ613R	测深器	60	把	1
8	ZK745R	导向器(护套,钻套)	Φ2.5/3.5	把	1
9	LS325R	双头导钻(插入导钻)	Φ2.5	把	1
10	ZQ859R	骨板折弯器	左、右,双槽200×3/4,斜口,单头	副	1
11	ZQ688R	骨膜剥离器	180×12平	把	1
12	ZK893R	骨钻	Φ2.5	支	2
13	ZK895R	骨钻	Φ3.2	支	2

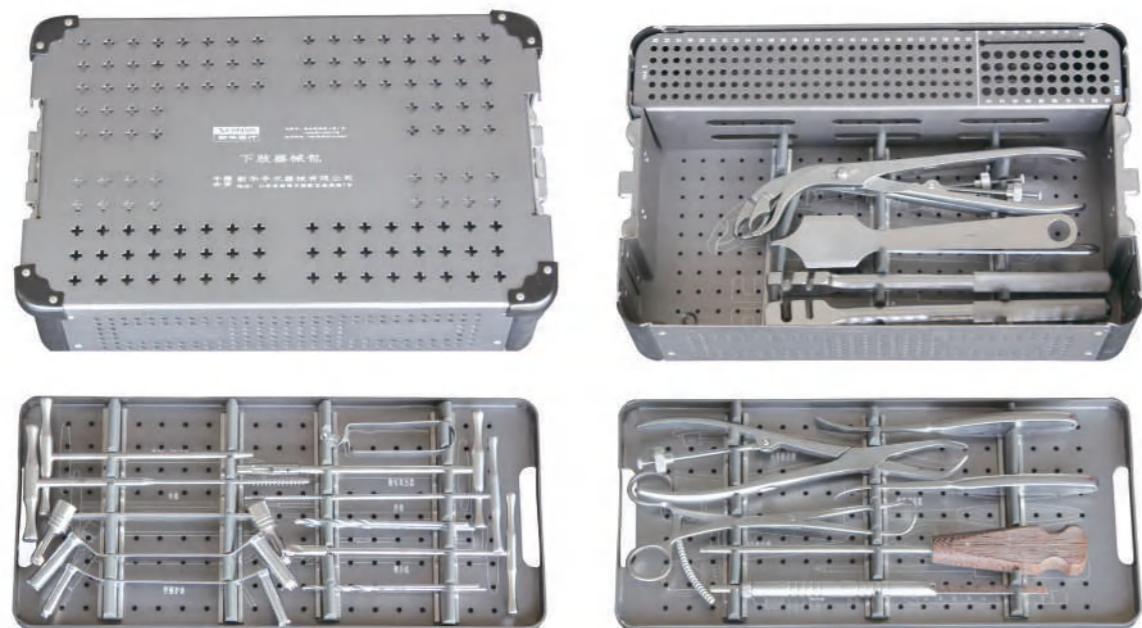

XZG- I 型下肢手术器械 (ZK301)  
XZG-I surgical instruments set for lower limb

序号	编码	名称	规格	单位	数量
1	ZQ853R	丝锥	HA4.5	把	1
2	ZQ855R	丝锥	HB6.5	把	1
3	ZQ901R	螺钉打滑器	SW3.5	把	1
4	LS024R	埋头钻	Φ8	把	1
5	ZK867R	空心钻	Φ5	把	1
6	ZQ902R	螺钉夹持器(钳)	H3.5 - 4.5	把	1
7	ZQ841R	六角起子(内六角螺丝刀)(内六方改锥)	SW3.5	把	1
8	ZK166R	带尖复位钳	210	把	1
9	ZK163R	复位钳	230	把	1
10	ZK162R	中心化持骨钳(复位钳)	270	把	2
11	LS004R	测深器	90	把	1
12	ZK747R	导向器(护套, 钻套)	Φ3.2/4.5	把	1
13	ZK748R	导向器(护套, 钻套)	Φ4.5/6.5	把	1
14	LS033R	双头导钻(插入导钻)	Φ3.2	把	1
15	ZQ754R	骨撬(牵开器)	240×18, 平	把	1
16	ZQ580R	骨撬(牵开器)	240×42, 平	把	1
17	ZQ861R	骨板折弯器	左、右, 双槽280×5/6, 斜口, 单头	把	1
18	ZQ768R	骨膜剥离器	180×10 圆	把	1
19	ZQ770R	骨膜剥离器	180×15 平	把	1
20	ZK895R	骨钻	Φ3.2	支	2
21	ZK891R	骨钻	Φ4.5	支	2

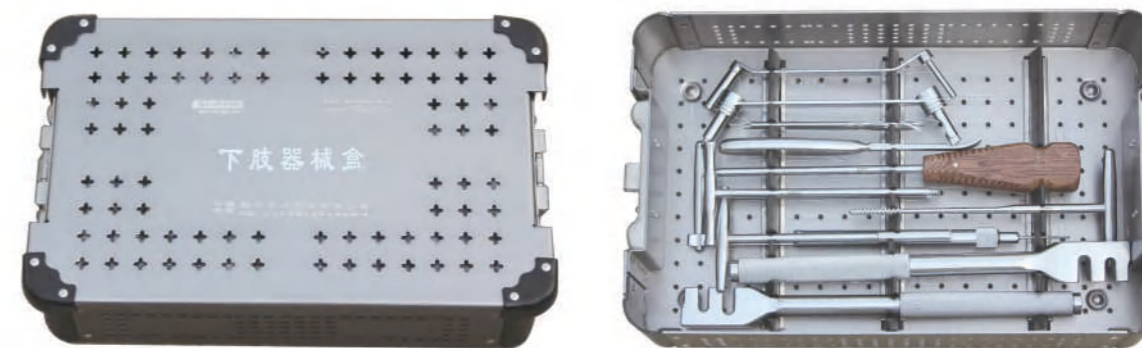

XZG- II 型简易下肢手术器械 (ZK299)  
XZG-II simple surgical instruments set for lower limb

序号	编码	名称	规格	单位	数量
1	ZQ853R	丝锥	HA4.5	把	1
2	ZQ855R	丝锥	HB6.5	把	1
3	ZQ901R	螺钉打滑器	SW3.5	把	1
4	LS024R	埋头钻	Φ8	把	1
5	ZK867R	空心钻	Φ5	把	1
6	ZQ841R	六角起子(内六角螺丝刀)(内六方改锥)	SW3.5	把	1
7	LS004R	测深器	90	把	1
8	ZK747R	导向器(护套, 钻套)	Φ3.2/4.5	把	1
9	LS033R	双头导钻(插入导钻)	Φ3.2	把	1
10	ZQ861R	骨板折弯器	左、右, 双槽280×5/6, 斜口, 单头	副	1
11	ZQ770R	骨膜剥离器	180×15 平	把	1
12	ZK895R	骨钻	Φ3.2	支	2
13	ZK891R	骨钻	Φ4.5	支	2

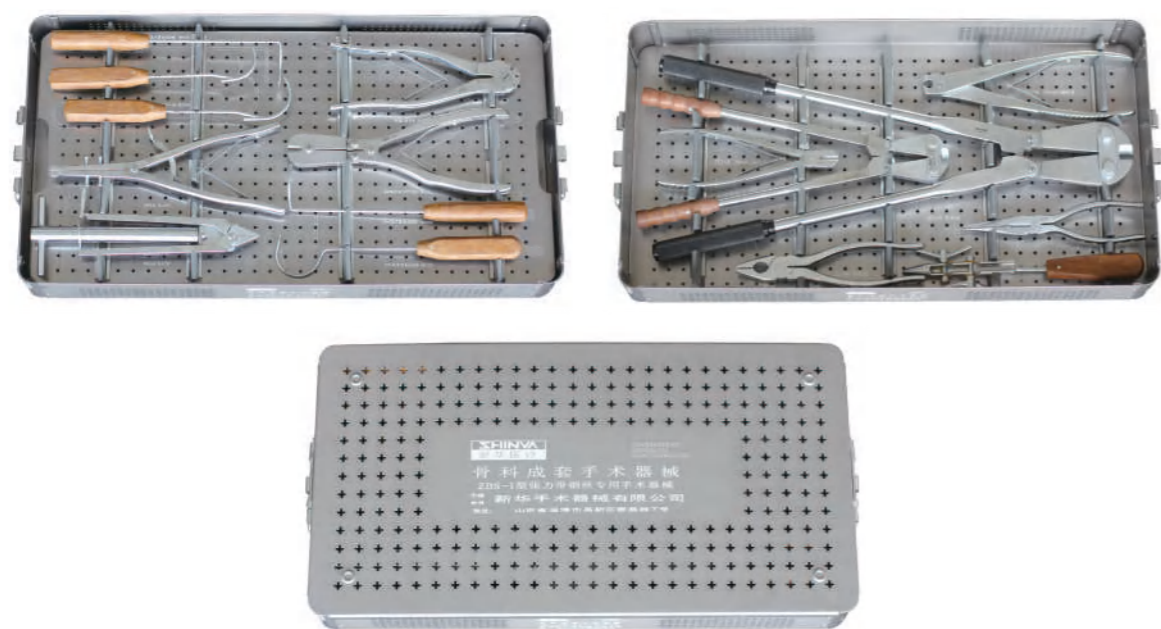

ZDS- I 型张力带钢丝专用手术器械 (ZS103)  
ZDS-I wire tightening surgical instruments set

序号	编码	名称	规格	单位	数量
1	ZK267R	克丝钳(钢丝钳)	200×Φ2,尖头	把	1
2	ZK268R	克丝钳(钢丝钳)	200×Φ2,虎头	把	1
3	ZK271R	紧丝钳		把	1
4	ZK272R	扎丝钳	245	把	1
5	ZK273R	钢针剪	200×Φ1.2	把	1
6	ZK274R	钢针剪	240×Φ2.5	把	1
7	ZK275R	钢针剪(钢丝剪)	350×(Φ1-Φ4)	把	1
8	ZK475R	钢针剪(钢丝剪)	240×Φ2.5 双面有刃	把	1
9	LS719R	大钢丝剪	500×Φ6,手柄可拆	把	1
10	ZK278R	克氏剪	205×Φ3.5,圆头	把	1
11	ZQ1148R	钢丝引导器(导丝器)	250×R23×48,左弯	把	1
12	ZQ1149R	钢丝引导器(导丝器)	250×R23×48,右弯	把	1
13	ZQ1150R	钢丝引导器(导丝器)	250×R23×48,直型	把	1
14	ZQ1151R	空心钢丝引导器	225×R24×35,直型	把	1
15	ZQ1152R	空心钢丝引导器	240×R30×50,直型	把	1
16	ZK277R	钢丝缠绕器	255	把	1



GPD- I 型骨盆骨折内固定专用手术器械 (ZS102)  
GPD-I internal fixation surgical instruments set for pelvic fractures

序号	编码	名称	规格	单位	数量
1	ZK173R	双爪复位钳	415	把	1
2	ZK174R	三爪复位钳	415	把	1
3	ZK175R	不对称双爪复位钳	415	把	1
4	ZK176R	弯头复位钳	240	把	1
5	ZK177R	弯头复位钳	270	把	1
6	ZK178R	直头复位钳	300	把	1
7	ZK179R	髌臼复位钳	340,撑开及压缩两用	把	1
8	ZQ908R	双向弯曲钳	270	把	1
9	ZK158R	多齿持骨钳	200,带自锁	把	1
10	ZQ957R	顶棒	300	把	1
11	ZQ629R	带尖活络座		只	2
12	ZQ627R	坐骨神经牵开器	310×30	把	1
13	ZQ863R	钢板折弯器	200,双头,左右	副	1



GND- I 型骨折内固定专用手术器械明细表 (ZS101)  
ND-I internal fixation surgical instruments set for pelvic fractures

序号	编码	名称	规格	单位	数量
1	ZK223R	导向持骨钳	小	把	1
2	ZK224R	导向持骨钳	中	把	1
3	ZK225R	导向持骨钳	大	把	1
4	ZK226R	三爪自定中心化持骨钳	250	把	1
5	ZQ235R	股骨撑开器	II型, 全长430	把	1
6	ZQ236R	股骨撑开器	I型, 全长350	把	1
7	ZK190R	骨把持器(骨折固定夹)	小	把	1
8	ZK191R	骨把持器(骨折固定夹)	中	把	1
9	ZK192R	骨把持器(骨折固定夹)	大	把	1
10	ZQ872R	断钉取出器(断螺钉拔出器)	HA3.5	把	1
11	ZQ898R	断钉取出器(断螺钉拔出器)	HA4.5	把	1
12	ZQ903R	断钉取出器(断螺钉拔出器)	HA6.5	把	1
13	ZQ237R	全自动保险起子	SW2.5	把	1
14	ZQ238R	全自动保险起子	SW3.5	把	1
15	ZQ241R	带套保险起子	SW2.5	把	2
16	ZQ242R	带套保险起子	SW3.5	把	2
17	ZQ243R	全自动保险起子	一字	把	2
18	ZQ722R	半月板钩	180×40×12	把	1
19	ZQ246R	半月板刀	左弯	把	1
20	ZQ247R	半月板刀	右弯	把	1
21	ZQ248R	半月板刀	直	把	1
22	ZK006R	手摇钻	夹持Φ6以下钻头	把	2
23	ZF870R	线锯条	500	包	1(20条装)

序号	编码	名称	规格	单位	数量
23	ZF870R	线锯条	500	包	1(20条装)
24	ZF872R	线锯手柄	2×1	套	1
25	ZA807R	X射线摄影尺	200	把	1
26	ZA808R	X射线摄影尺	300	把	1
27	ZA809R	X射线摄影尺	400	把	1
28	ZK725R	软管钻钻头(分体型)	Φ2.5	支	1
29	ZK726R	软管钻钻头(分体型)	Φ3.2	支	1
30	ZK727R	软管钻钻头(分体型)	Φ3.5	支	1
31	ZK729R	软管钻钻头(分体型)	Φ4.5	支	1
32	ZK159R	多齿持骨钳	250, 带自锁	把	1
33	ZK141R	多齿持骨钳(不带齿条)	260	把	1
34	ZL878R	长肋骨剪	340	把	1
35	ZK733R	C形导钻	1#(35×Φ6 导钻架, Φ2.5, Φ3.5导钻头)	套	1
36	ZK734R	C形导钻	2#(42×Φ6导钻架, Φ3.2、Φ4.5导钻头)	套	1
37	ZK735R	C形导钻	3#(42×Φ8导钻架, Φ6.5导钻头)	套	1



撑开钳  
Distractor

★ **ZQ4138RN**  
175×32, 双孔, 足踝, 克氏针



骨科用撑开钳  
Distractor

★ **ZQ4166RN**  
210 双孔 撑开尺寸4~9cm  
孔 $\phi$ 2.6,  $\phi$ 1.6  
opening:4-9cm  
hole: $\phi$ 2.6, $\phi$ 1.6



骨科用撑开钳  
Distractor

★ **ZQ4167RN**  
220 双孔 撑开尺寸9~15cm  
孔 $\phi$ 2.6,  $\phi$ 1.6  
opening:9-15cm  
hole: $\phi$ 2.6, $\phi$ 1.6



★ 压缩钳  
compression forceps

**ZQ4139RN**  
170×32, 双孔



★ 撑开钳  
Distractor

**ZQ4140RN**  
180



★ 撑开钳  
Distractor

**ZQ4141RN**  
180



咬骨钳  
Bone rongeur

**ZQ4136RN**  
185, 直 straight

**ZQ4137RN**  
185, 弯 curved



钢丝剪  
Wire cutting scissors

★ **ZK283RN**  
215× $\phi$ 2.5



骨刀  
Osteotome, thin blade, PPSU handle

**ZQ4151RN**  
220×4, 直, 超薄刃,  
PPSU柄

★ **ZQ4152RN**  
220×8, 直, 超薄刃,  
PPSU柄

★ **ZQ4112RN**  
220×10, 直, 超薄刃,  
PPSU柄

★ **ZQ4113RN**  
220×12, 直, 超薄刃,  
PPSU柄

★ **ZQ4114RN**  
220×15, 直, 超薄刃,  
PPSU柄

**ZQ4115RN**  
220×20, 直, 超薄刃,  
PPSU柄

**ZQ4116RN**  
220×25, 直, 超薄刃,  
PPSU柄



软骨铲  
Cartilage chisel, PPSU handle

**ZQ4118RN**  
220×13, 内刃, inside blade  
PPSU柄

**ZQ4119RN**  
220×8.5, 外刃, outside blade  
PPSU柄



骨锤  
Bone hammer  
**ZQ4120RN**  
220/270G



钢板折弯钳  
Plate bending forceps  
**ZK1064RN**  
190  
**ZK1063RN**  
140



骨凿  
Gouge  
**ZQ4177RN**  
125×4, 半圆



骨刀  
**ZQ4117RN**  
125×6, 直头



神经剥离器  
Nerve dissector  
**ZQ4125RN**  
175×5×3.5,  
双头



骨膜剥离器  
Periosteal raspator  
**ZQ4124RN**  
160×11×4.5,  
双头



骨膜剥离器  
Periosteal raspator  
**ZQ4121RN**  
165×7, 圆刃  
**ZQ4122RN**  
180×15, 圆刃  
**ZQ4123RN**  
180×20, 圆刃



骨刮匙  
Bone curette  
**ZQ4195RN**  
260×8, 直  
★ **ZQ1358R**  
260×4, 直  
★ **ZQ1374R**  
260×6, 直



骨刮匙  
Bone curette  
**ZQ4126RN**  
175×2, 直  
**ZQ4127RN**  
175×4, 直  
**ZQ4184RN**  
175×6, 直



(球窝锉) 快装手柄  
Quick coupling handle  
**ZQ4174RN**  
67



球窝锉(凹锉)  
Ball socket file(concave)  
**ZQ4155RN**      **ZQ4162RN**  
87×Φ24, 凹型      87×Φ18, 凹型  
**ZQ4153RN**      **ZQ4148RN**  
87×Φ22, 凹型      87×Φ16, 凹型  
**ZQ4146RN**      **ZQ4149RN**  
87×Φ20, 凹型      87×Φ14, 凹型



球窝锉(凸锉)  
Ball socket file(convex)  
**ZQ4147RN**      **ZQ4154RN**  
87×Φ16, 凸型      87×Φ22, 凸型  
**ZQ4161RN**      **ZQ4145RN**  
87×Φ14, 凸型      87×Φ20, 凸型  
**ZQ4163RN**      **ZQ4156RN**  
87×Φ18, 凸型      87×Φ24, 凸型





乳突牵开器  
Self-retaining retractor

**ZV074RN**  
110×14, 固定式  
2×3钩, 直型



骨科复位钳  
Reposition forceps

**ZK229RN**  
110, 带尖  
**ZK186RN**  
155, 带尖



骨科复位钳  
Reposition forceps

**ZK232RN**  
260, 髌骨 for patella



拉钩  
Retractor

**ZQ4172RN**  
120, 10×25/10×25



皮肤拉钩  
Skin retractor

**ZQ4132RN**  
165×9×8, 三钩, 钝  
three teeth, blunt  
**ZQ4181RN**  
170×8×9, 钝  
three teeth, blunt



皮肤拉钩  
Skin retractor

板型  
**ZQ4182RN**  
170×6×15, 钝 blunt



鞍型

**ZQ4131RN**  
170×8.5×17.5, 钝 blunt



骨撬  
Bone lever

**ZQ4128RN**  
160×6, 弯 curved

**ZQ4129RN**  
160×8, 弯 curved



骨撬  
Bone lever

**ZQ4171RN**  
154×5.5, 弯 curved



精细手术剪  
Delicate dissecting scissors

**ZC050RNH**  
125, 弯尖, 解剖型  
curved/sharp



测深器  
Depth gauge

**ZQ4178RN**  
最大测量深度45mm  
max.measurement:45mm



测深器  
Depth gauge

**ZQ4134RN**  
最大测量深度60mm  
max.measurement:60mm



植骨器  
Bone grafting impactor

**ZQ4143RN**  
185(弧形) curved

**ZQ4144RN**  
185(直形) flat

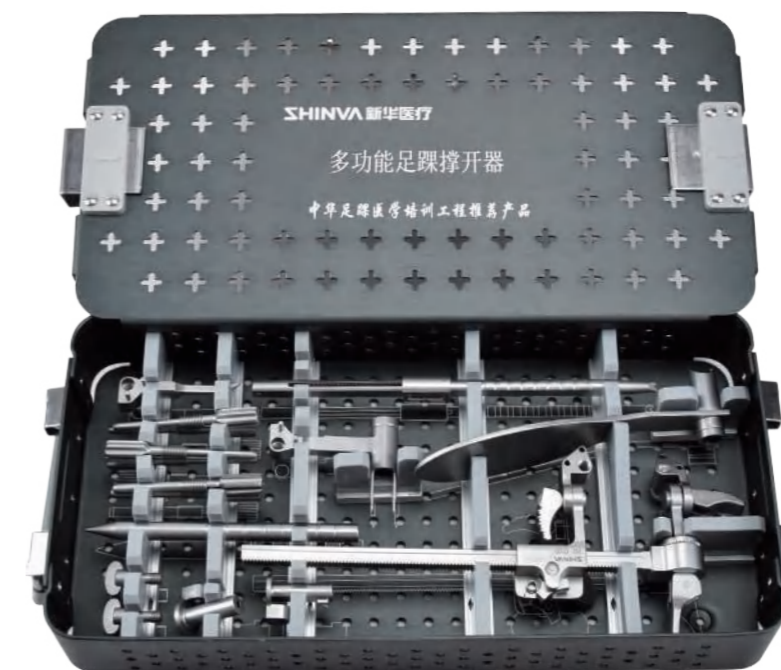

骨科撑开器  
Ankle spreader

★ **ZQ1321RN**  
200, 足踝

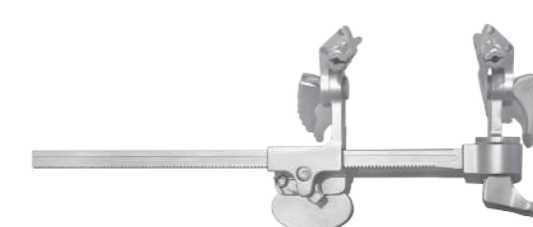
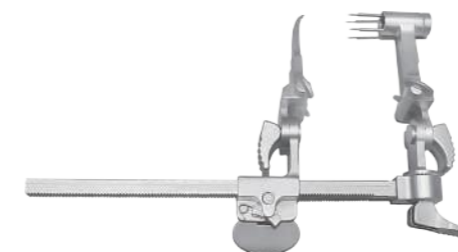



ZHQ- X 前足足踝手术器械包 (ZQ4193)  
Forefoot and ankle surgical instrument set (ZQ4193)

序号	产品编码	产品名称	规格型号	数量	单位
1	ZQ4117RN	骨刀	125×6, 直头	1	把
2	ZQ4177RN	骨凿	125×4, 半圆	1	把
3	ZQ4121RN	骨膜剥离器	165×7, 圆刃	1	把
4	ZQ4122RN	骨膜剥离器	180×15, 圆刃	1	把
5	ZQ4124RN	骨膜剥离器	160×11×4.5, 双头	1	把
6	ZQ4125RN	神经剥离器	175×5×3.5, 双头	1	把
7	ZQ4128RN	骨撬	160×6, 弯	1	把
8	ZQ4129RN	骨撬	160×8, 弯	1	把
9	ZQ4171RN	骨撬	154×5.5, 弯	2	把
10	ZQ4181RN	皮肤拉钩	170×8×9, 钝	2	把
11	ZQ4182RN	皮肤拉钩	170×6×15, 钝	2	把
12	ZQ4131RN	皮肤拉钩	170×8.5×17.5, 钝	2	把
13	ZQ4178RN	测深器	45	1	把
14	ZK283RN	钢丝剪	215×Φ2.5	1	把
15	ZQ4136RN	咬骨钳	185, 直	1	把
16	ZQ4137RN	咬骨钳	185, 弯	1	把
17	LS059R	医用尺	200	1	把
18	ZQ4172RN	拉钩	120, 10×25/10×25	2	把
19	ZV074RN	乳突牵开器	110×14, 固定式2×3钩, 直型	1	把
20	ZK229RN	骨科复位钳	110, 带尖	1	把
21	ZK186RN	骨科复位钳	155, 带尖	1	把
22	ZB073RN	手术刀柄	3#	2	把

序号	产品编码	产品名称	规格型号	数量	单位
23	ZQ4174RN	快装手柄	67	1	把
24	ZQ4145RN	骨锉	87×Φ20, 凸型	1	把
25	ZQ4146RN	骨锉	87×Φ20, 凹型	1	把
26	ZQ4147RN	骨锉	87×Φ16, 凸型	1	把
27	ZQ4148RN	骨锉	87×Φ16, 凹型	1	把
28	ZQ4149RN	骨锉	87×Φ14, 凹型	1	把
29	ZQ4161RN	骨锉	87×Φ14, 凸型	1	把
30	ZQ4162RN	骨锉	87×Φ18, 凹型	1	把
31	ZQ4163RN	骨锉	87×Φ18, 凸型	1	把
32	ZQ4153RN	骨锉	87×Φ22, 凹型	1	把
33	ZQ4154RN	骨锉	87×Φ22, 凸型	1	把
34	ZQ4155RN	骨锉	87×Φ24, 凹型	1	把
35	ZQ4156RN	骨锉	87×Φ24, 凸型	1	把
36	ZQ4143RN	植骨器	185	1	把
37	ZQ4144RN	植骨器	185	1	把
38	ZQ4120RN	骨锤	220/270g	1	把
39	ZK1063RN	折弯钳	140	1	把
40	ZK1064RN	折弯钳	190	1	把
41	ZQ4126RN	骨刮匙	175×2, 直	1	把
42	ZQ4127RN	骨刮匙	175×4, 直	1	把
43	ZQ4184RN	骨刮匙	175×6, 直	1	把



ZHQ-VIII 后足足踝手术器械包 (ZQ4179)  
Hindfoot and ankle surgical instrument set (ZQ4179)

序号	产品编码	产品名称	规格型号	数量	单位
1	ZQ4151RN	骨刀	220×4, 直, 超薄刃, PPSU柄	1	把
2	ZQ4152RN	骨刀	220×8, 直, 超薄刃, PPSU柄	1	把
3	ZQ4112RN	骨刀	220×10, 直, 超薄刃, PPSU柄	1	把
4	ZQ4113RN	骨刀	220×12, 直, 超薄刃, PPSU柄	1	把
5	ZQ4114RN	骨刀	220×15, 直, 超薄刃, PPSU柄	1	把
6	ZQ4115RN	骨刀	220×20, 直, 超薄刃, PPSU柄	1	把
7	ZQ4116RN	骨刀	220×25, 直, 超薄刃, PPSU柄	1	把
8	ZQ4118RN	骨刀	220×13, 内刃, PPSU柄	1	把
9	ZQ4119RN	骨刀	220×8.5, 外刃, PPSU柄	1	把
10	ZQ4120RN	骨锤	220/270g	1	把
11	ZQ4123RN	骨膜剥离器	180×20, 圆刃	1	把
12	ZQ4195R	骨刮匙	260×8, 直	1	把
13	ZQ1358R	骨刮匙	260×4, 直	1	把
14	ZQ1374R	骨刮匙	260×6, 直	1	把
15	ZQ4132RN	皮肤拉钩	165×9×8, 三钩, 钝	2	把
16	ZQ4134RN	测深器	60	1	把
17	ZK283RN	钢丝剪	215×Φ2.5	1	把

序号	产品编码	产品名称	规格型号	数量	单位
18	ZQ4136RN	咬骨钳	185, 直	1	把
19	ZQ4137RN	咬骨钳	185, 弯	1	把
20	ZQ4138RN	骨科撑开器	175×32, 双孔, 足踝, 克氏针	1	把
21	ZQ4139RN	压缩钳	170×32, 双孔	1	把
22	ZQ4140RN	骨科撑开器	180	1	把
23	ZQ4141RN	骨科撑开器	180	1	把
24	ZC050RNh	精细手术剪	125, 弯尖, 解剖型	1	把
25	ZQ4143RN	植骨器	185	1	把
26	ZQ4144RN	植骨器	185	1	把
27	ZK186RN	骨科复位钳	155, 带尖	1	把
28	ZK232RN	骨科复位钳	260, 髌骨	1	把
29	ZQ4172RN	拉钩	120, 10×25/10×25	2	把
30	LS059R	医用尺	200	1	把
31	ZQ4128RN	骨撬	160×6, 弯	1	把
32	ZQ4129RN	骨撬	160×8, 弯	1	把
33	ZQ4174RN	快装手柄	67	1	把
34	ZK1064RN	折弯钳	190	2	把



撑开钳  
Distractor

★ ZQ4138RNh  
175×32, 双孔, 足踝, 克氏针  
with two holes



压缩钳  
Compression forceps

★ ZQ4139RNh  
170×32, 双孔  
with two holes



撑开钳  
Distractor

★ ZQ4140RNh  
180



撑开钳  
Distractor

★ ZQ4141RNh  
180



咬骨钳  
Bone rongeur

ZQ4136RNh  
185, 直 straight

ZQ4137RNh  
185, 弯 curved



钢丝剪  
Wire cutting scissors

★ ZK283RNh  
215×Φ2.5



骨刀  
Thin osteotome, PPSU handle

ZQ4151RNh  
220×4, 直, 超薄刃,  
PPSU柄

★ ZQ4152RNh  
220×8, 直, 超薄刃,  
PPSU柄

★ ZQ4112RNh  
220×10, 直, 超薄刃,  
PPSU柄

★ ZQ4113RNh  
220×12, 直, 超薄刃,  
PPSU柄

★ ZQ4114RNh  
220×15, 直, 超薄刃,  
PPSU柄

ZQ4115RNh  
220×20, 直, 超薄刃,  
PPSU柄

ZQ4116RNh  
220×25, 直, 超薄刃,  
PPSU柄



软骨铲  
Cartilage chisel,  
PPSU handle

ZQ4118RNh  
220×13, 内刃,  
PPSU柄 inside blade

ZQ4119RNh  
220×8.5, 外刃,  
PPSU柄 outside blade



骨锤  
Bone hammer

ZQ4120RNh  
220/270G



钢板折弯钳  
Plate bending forceps

ZK1064RNh  
190

ZK1063RNh  
140



骨凿  
Gouge

**ZQ4177RNH**  
125×4, 半圆



骨刀  
Osteotome

**ZQ4117RNH**  
125×6, 直头



骨膜剥离器  
Periosteal raspatory

**ZQ4124RNH**  
160×11×4.5,  
双头  
double ended



骨刮匙  
Bone curette

**ZQ4126RNH**  
175×2, 直

**ZQ4127RNH**  
175×4, 直

**ZQ4184RNH**  
175×6, 直



(球窝锉) 快装手柄  
Quick coupling handle

**ZQ4174RNH**  
67



骨膜剥离器  
Periosteal raspatory

**ZQ4121RNH**  
165×7, 圆刃

**ZQ4122RNH**  
180×15, 圆刃

**ZQ4123RNH**  
180×20, 圆刃



神经剥离器  
Nerve dissector

**ZQ4125RNH**  
175×5×3.5,  
双头



骨刮匙  
Bone curette,  
silicone handle

**ZQ4195RNH**  
260×8, 直

★ **ZQ1358RNH**  
260×4, 直

★ **ZQ1374RNH**  
260×6, 直



球窝锉(凹锉)  
Ball joint file,concave

**ZQ4155RNH**  
87×Φ24, 凹型

**ZQ4153RNH**  
87×Φ22, 凹型

**ZQ4146RNH**  
87×Φ20, 凹型

**ZQ4162RNH**  
87×Φ18, 凹型

**ZQ4148RNH**  
87×Φ16, 凹型

**ZQ4149RHN**  
87×Φ14, 凹型



球窝锉(凸锉)  
Ball joint file,convex

**ZQ4147RNH**  
87×Φ16, 凸型

**ZQ4161RNH**  
87×Φ14, 凸型

**ZQ4163RNH**  
87×Φ18, 凸型

**ZQ4154RNH**  
87×Φ22, 凸型

**ZQ4145RNH**  
87×Φ20, 凸型

**ZQ4156RNH**  
87×Φ24, 凸型





乳突牵开器  
Self-retaining retractor

**ZV074RNh**  
110×14, 固定式  
2×3钩, 直型



骨科复位钳  
Reposition forceps

**ZK229RNh**  
110, 带尖  
  
**ZK186RNh**  
155, 带尖



骨科复位钳  
Reposition forceps

**ZK232RNh**  
260, 髌骨  
for patella



拉钩  
Retractor

**ZQ4172RNh**  
120, 10×25/10×25



皮肤拉钩  
Skin retractor

**ZQ4132RNh**  
165×9×8, 三钩, 钝  
three teeth, blunt

**ZQ4181RNh**  
170×8×9, 钝  
three teeth, blunt



皮肤拉钩  
Skin retractor

板型

**ZQ4182RNh**  
170×6×15, 钝

鞍型

**ZQ4131RNh**  
170×8.5×17.5, 钝



骨撬  
Bone lever

**ZQ4128RNh**  
160×6, 弯 curved

**ZQ4129RNh**  
160×8, 弯 curved



骨撬  
Bone lever

**ZQ4171RNh**  
154×5.5, 弯 curved



精细手术剪  
Delicate dissecting  
scissors

**ZC050RNh**  
125, 弯尖, 解剖型  
curved/sharp



测深器  
Depth gauge

**ZQ4134RNh**  
最大测量深度60mm  
Max. measurement:60mm

**ZQ4178RNh**  
最大测量深度45mm  
Max. measurement:45mm



植骨器  
Bone grafting impactor

**ZQ4143RNh**  
185(弧形) curved

**ZQ4144RNh**  
185(直形) flat



医用尺  
Medical ruler

**LS059R**  
200



手术刀柄  
Scalpel handle

**ZB073RN**  
3#



ZHQ-XI前足足踝手术器械包 (ZQ4194)  
Forefoot and ankle surgical instrument set (ZQ4194)

序号	产品编码	产品名称	规格型号	数量	单位
1	ZQ4117RNh	骨刀	125×6,直头	1	把
2	ZQ4177RNh	骨凿	125×4,半圆	1	把
3	ZQ4121RNh	骨膜剥离器	165×7,圆刃	1	把
4	ZQ4122RNh	骨膜剥离器	180×15,圆刃	1	把
5	ZQ4124RNh	骨膜剥离器	160×11×4.5,双头	1	把
6	ZQ4125RNh	神经剥离器	175×5×3.5,双头	1	把
7	ZQ4128RNh	骨撬	160×6,弯	1	把
8	ZQ4129RNh	骨撬	160×8,弯	1	把
9	ZQ4171RNh	骨撬	154×5.5,弯	2	把
10	ZQ4181RNh	皮肤拉钩	170×8×9,钝	2	把
11	ZQ4182RNh	皮肤拉钩	170×6×15,钝	2	把
12	ZQ4131RNh	皮肤拉钩	170×8.5×17.5,钝	2	把
13	ZQ4178RNh	测深器	45	1	把
14	ZK283RNh	钢丝剪	215×Φ2.5	1	把
15	ZQ4136RNh	咬骨钳	185,直	1	把
16	ZQ4137RNh	咬骨钳	185,弯	1	把
17	LS059R	医用尺	200	1	把
18	ZQ4172RNh	拉钩	120,10×25/10×25	2	把
19	ZV074RNh	乳突牵开器	110×14,固定式2×3钩,直型	1	把
20	ZK229RNh	骨科复位钳	110,带尖	1	把
21	ZK186RNh	骨科复位钳	155,带尖	1	把
22	ZB073RN	手术刀柄	3#	2	把

序号	产品编码	产品名称	规格型号	数量	单位
23	ZQ4174RNh	快装手柄	67	1	把
24	ZQ4145RNh	骨锉	87×Φ20,凸型	1	把
25	ZQ4146RNh	骨锉	87×Φ20,凹型	1	把
26	ZQ4147RNh	骨锉	87×Φ16,凸型	1	把
27	ZQ4148RNh	骨锉	87×Φ16,凹型	1	把
28	ZQ4149RNh	骨锉	87×Φ14,凹型	1	把
29	ZQ4161RNh	骨锉	87×Φ14,凸型	1	把
30	ZQ4162RNh	骨锉	87×Φ18,凹型	1	把
31	ZQ4163RNh	骨锉	87×Φ18,凸型	1	把
32	ZQ4153RNh	骨锉	87×Φ22,凹型	1	把
33	ZQ4154RNh	骨锉	87×Φ22,凸型	1	把
34	ZQ4155RNh	骨锉	87×Φ24,凹型	1	把
35	ZQ4156RNh	骨锉	87×Φ24,凸型	1	把
36	ZQ4143RNh	植骨器	185	1	把
37	ZQ4144RNh	植骨器	185	1	把
38	ZQ4120RNh	骨锤	220/270g	1	把
39	ZK1063RNh	折弯钳	140	1	把
40	ZK1064RNh	折弯钳	190	1	把
41	ZQ4126RNh	骨刮匙	175×2,直	1	把
42	ZQ4127RNh	骨刮匙	175×4,直	1	把
43	ZQ4184RNh	骨刮匙	175×6,直	1	把



ZHQ-IX 后足足踝手术器械包 (ZQ4180)  
Hindfoot and ankle surgical instrument set (ZQ4180)

序号	产品编码	产品名称	规格型号	数量	单位
1	ZQ4151RNh	骨刀	220×4, 直, 超薄刃, PPSU柄	1	把
2	ZQ4152RNh	骨刀	220×8, 直, 超薄刃, PPSU柄	1	把
3	ZQ4112RNh	骨刀	220×10, 直, 超薄刃, PPSU柄	1	把
4	ZQ4113RNh	骨刀	220×12, 直, 超薄刃, PPSU柄	1	把
5	ZQ4114RNh	骨刀	220×15, 直, 超薄刃, PPSU柄	1	把
6	ZQ4115RNh	骨刀	220×20, 直, 超薄刃, PPSU柄	1	把
7	ZQ4116RNh	骨刀	220×25, 直, 超薄刃, PPSU柄	1	把
8	ZQ4118RNh	骨刀	220×13, 内刃, PPSU柄	1	把
9	ZQ4119RNh	骨刀	220×8.5, 外刃, PPSU柄	1	把
10	ZQ4120RNh	骨锤	220/270g	1	把
11	ZQ4123RNh	骨膜剥离器	180×20, 圆刃	1	把
12	ZQ4195RNh	骨刮匙	260×8, 直	1	把
13	ZQ1358RNh	骨刮匙	260×4, 直	1	把
14	ZQ1374RNh	骨刮匙	260×6, 直	1	把
15	ZQ4132RNh	皮肤拉钩	165×9×8, 三钩, 钝	2	把
16	ZQ4134RNh	测深器	60	1	把
17	ZK283RNh	钢丝剪	215×Φ2.5	1	把

序号	产品编码	产品名称	规格型号	数量	单位
18	ZQ4136RNh	咬骨钳	185, 直	1	把
19	ZQ4137RNh	咬骨钳	185, 弯	1	把
20	ZQ4138RNh	骨科撑开器	175×32, 双孔, 足踝, 克氏针	1	把
21	ZQ4139RNh	压缩钳	170×32, 双孔	1	把
22	ZQ4140RNh	骨科撑开器	180	1	把
23	ZQ4141RNh	骨科撑开器	180	1	把
24	ZC050RNh	精细手术剪	125, 弯尖, 解剖型	1	把
25	ZQ4143RNh	植骨器	185	1	把
26	ZQ4144RNh	植骨器	185	1	把
27	ZK186RNh	骨科复位钳	155, 带尖	1	把
28	ZK232RNh	骨科复位钳	260, 髌骨	1	把
29	ZQ4172RNh	拉钩	120, 10×25/10×25	2	把
30	LS059R	医用尺	200	1	把
31	ZQ4128RNh	骨撬	160×6, 弯	1	把
32	ZQ4129RNh	骨撬	160×8, 弯	1	把
33	ZQ4174RNh	快装手柄	67	1	把
34	ZK1064RNh	折弯钳	190	2	把

外科牵开器  
Surgical retractors  
(hallux valgus corrector)

ZQ1336RN 94

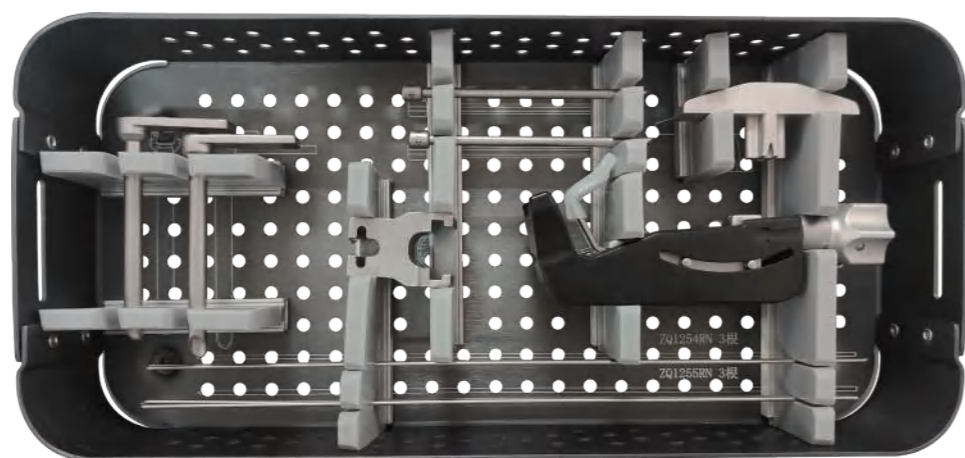

ZQ1410微创拇外翻截骨矫形导向器械 I 型  
Minimally invasive guide device for hallux valgus osteotomy and correction

序号	产品编码	产品名称	规格型号	数量	单位
1	ZQ1336RN	外科牵开器	94	1	把
2	ZK937R	骨牵引针	φ1.4×250	3	支
3	ZK938R	骨牵引针	φ1.6×250	2	支
4	ZK985R	骨牵引针	φ0.8×250	3	支
5	ZK879R	骨牵引针	φ1.2×250	3	支

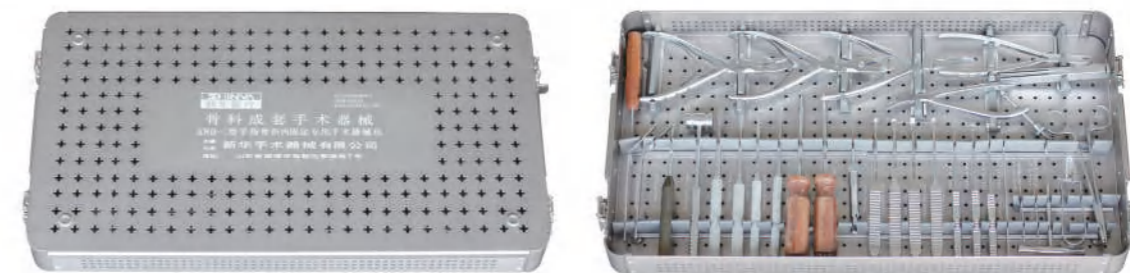

SND- I 型手指骨折内固定专用手术器械 (ZK101)  
SND-I internal fixation surgical instruments set for fingers

序号	编码	名称	规格	单位	数量
1	ZK576R	双关节咬骨钳	160×2×20°, 弯头	把	1
2	ZK683R	双关节咬骨钳	160×3×20°, 弯头	把	1
3	ZK614R	双关节咬骨剪	170, 弯	把	1
4	ZK227R	手指持骨钳	170	把	1
5	ZK228R	侧弯持骨钳	140	把	1
6	ZQ906R	螺钉夹持钳	HA2.0	把	1
7	ZQ249R	测深器	30	把	1
8	ZQ250R	一字起子	200	把	1
9	ZQ251R	内六角起子	200, SW2.0	把	1
10	ZQ849R	丝锥	HA2×135	把	1
11	ZQ632R	手指钢板弯曲器	120	把	2
12	ZK045R	骨锤	180/50g	把	1
13	ZQ790R	薄型骨刀	180×2	把	1
14	ZQ792R	薄型骨刀	180×4	把	1
15	ZQ794R	薄型骨刀	180×6	把	1
16	ZQ395R	骨刀	180×4, 直圆刃	把	1
17	ZQ633R	骨膜剥离器	160×5, 微弯	把	1
18	ZQ634R	骨膜剥离器	160×5, 深弯	把	1
19	ZQ635R	骨膜分离器	160×5, 微弯	把	1
20	ZQ636R	骨膜分离器	160×5, 深弯	把	1
21	ZQ637R	骨刮匙	160×2	把	1
22	ZQ638R	骨刮匙	160×3	把	1
23	ZQ639R	骨刮匙	160×4	把	1
24	ZK509R	指骨锉	190	把	1
25	ZQ640R	手钻	160×φ1.6	把	1
26	ZQ641R	牵开拉钩	小, 直	把	1
27	ZQ642R	牵开拉钩	大, 直	把	1
28	ZQ643R	牵开拉钩	小, 弯	把	1
29	ZQ644R	牵开拉钩	大, 弯	把	1
30	ZK730R	不锈钢钻头	100×φ1.5	支	3
31	ZK731R	不锈钢钻头	100×φ1.8	支	3
32	ZQ907R	螺钉夹持镊	HA2.0	只	1

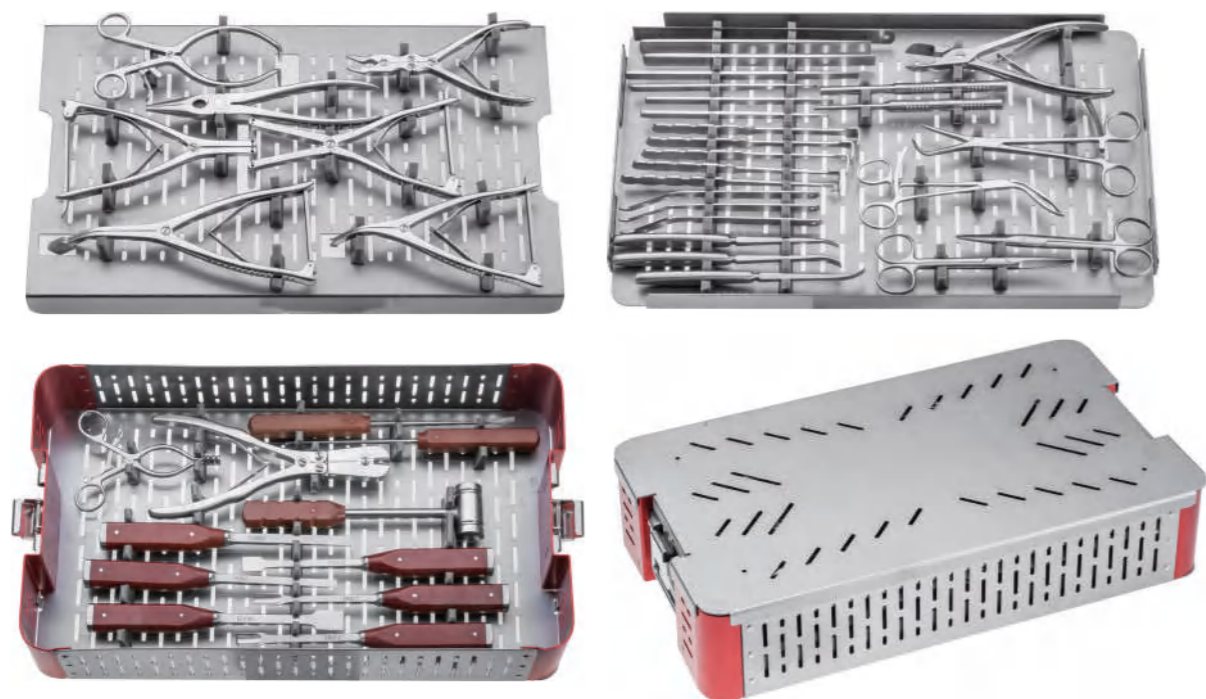

ZHQ- I 型足踝手术器械包 (ZK305)  
ZHQ-I ankle surgical instruments set

序号	编码	名称	规格	单位	数量
1	LS059R	医用尺	200	把	1
2	ZQ2800RB	骨刀	200×20	把	1
3	ZQ2801RB	骨刀	200×15	把	1
4	ZQ2802RB	骨刀	200×10	把	1
5	ZQ2803RB	骨刀	160×8	把	1
6	ZQ2804RB	骨刀	160×6	把	1
7	ZQ2805RB	骨刀	160×4	把	1
8	ZT128R	皮肤拉钩	175×19×16, 四齿	把	1
9	ZT129R	皮肤拉钩	175×19×11, 三齿	把	1
10	ZT130R	皮肤拉钩	175×19×6, 二齿	把	1
11	ZT131R	皮肤拉钩	175×19×6.5	把	1
12	ZT132R	皮肤拉钩	180×7.5×4.5, 二齿	把	1
13	ZT563R	骨撬	165×6.5	把	1
14	ZT564R	骨撬	165×9	把	1
15	ZT565R	骨撬	165×15	把	1
16	ZQ993RN	骨膜剥离器	190×15, 平刃	把	1
17	ZQ994RN	骨膜剥离器	190×10, 平刃	把	1
18	ZQ995RN	骨膜剥离器	190×8, 圆刃	把	1
19	ZK622R	咬骨剪	180, 直	把	1
20	ZQ922RB	锤骨器	160×Φ4	把	1
21	ZQ923RB	锤骨器	160×Φ8	把	1
22	ZK165R	复位钳	190mm	把	1
23	ZK187R	足踝持骨钳	165mm	把	1

序号	编码	名称	规格	单位	数量
24	ZC545RBr	组织剪	160直	把	1
25	ZC555RBr	组织剪	160弯	把	1
26	ZQ1324R	足踝撑开器	230×16	把	1
27	ZQ1326R	足踝撑开器	180×7.5	把	1
28	ZQ1325R	足踝克什针撑开器	170×40, 双孔	把	1
29	ZQ1545R	压缩钳	180×40, 双孔	把	1
30	ZK267R	克丝(氏)钳	200×Φ2, 尖头	把	1
31	ZK576R	咬骨钳	160×2×20°, 弯头	把	1
32	ZV298R	椎板牵开器	165×18, 单钩	把	1
33	ZV081R	乳突牵开器	165×16, 2×3钩	把	1
34	ZQ1338RB	骨刮匙	240×3, 胶木柄	把	1
35	ZQ1339RB	骨刮匙	240×5, 胶木柄	把	1
36	ZK475R	钢针剪	240×Φ2.5, 双面有刃	把	1
37	ZQ297R	骨锤	230/250g, 胶木柄	把	1
38	ZQ2806RB	骨刀(胶木柄)	240×8, 直刃	把	1
39	ZQ2807RB	骨刀(胶木柄)	240×10, 直刃	把	1
40	ZQ2808RB	骨刀(胶木柄)	240×15, 直刃	把	1
41	ZQ2809RB	骨刀(胶木柄)	240×20, 直刃	把	1
42	ZQ2810RB	骨刀(胶木柄)	240×12, 圆刃	把	1
43	ZQ2811RB	骨刀(胶木柄)	240×12, 圆刃	把	1

十字改锥 (起子)  
Cross Screwdriver

- ★ LS722R 小, 上肢,  $\phi 5.5 \times 0.78$
- ★ ZQ843R 大, 下肢,  $\phi 7.9 \times 1$



一字改锥 (起子)  
Flat Screwdriver

- ★ LS663R 小, 上肢, 245x5
- ★ ZQ839R 大, 下肢, 245x7
- ★ ZQ250R 200, 手指, 200x3



内六方改锥 (起子)  
Hex Screwdriver

- ★ ZQ255R SW1.5
- ★ ZQ840R SW2.5
- ★ ZQ251R SW2.0
- ★ ZQ842R SW4.5
- ★ ZQ841R SW3.5
- ★ ZQ291R SW4.0
- ★ ZQ290R SW3.0

注: “sw” 表示六角对边距离



梅花起子

Torx Screwdriver

- |                        |                         |                         |
|------------------------|-------------------------|-------------------------|
| ZQ261R $\phi 1.7$ (T6) | ZQ269R $\phi 2.7$ (T10) | ZQ266R $\phi 4.3$ (T25) |
| ZQ262R $\phi 2.0$ (T7) | ZQ271R $\phi 3.0$       | ZQ275R $\phi 5.0$ (T27) |
| ZQ264R $\phi 2.3$ (T8) | ZQ265R $\phi 3.4$ (T15) | ZQ276R $\phi 5.5$ (T30) |
| ZQ268R $\phi 2.5$ (T9) | ZQ274R $\phi 3.8$ (T20) |                         |



万向内六角起子  
Universal Hex Screwdriver

- ZQ256R SW2.5
- ZQ257R SW3.0
- ZQ258R SW3.5
- ZQ259R SW4.0
- ZQ260R SW4.5



上钉器  
Screw Applier

- ZQ1331R 290, I型, 竹节柄



- ZQ1332R 290, II型, 竹节柄



起子  
Hex screwdriver set

- ★ ZK284 Hex  
内六方: SW1.5/SW2.0 SW2.5/SW2.5 SW3.0/SW4.0  
SW4.0/SW4.5 SW3.5/2.4 1.2/1.5



- ★ ZK285 Torx  
梅花: T2.3/T2.3 T2.8/T3.8 T3.1/T4.3  
T3.4/T4.3 T4.5/T5.3 3/5



断钉拔出钳  
Broken Screw Removal Forceps

★ ZQ2121RN 200, 夹持H3-5  
for H3-5



剥离钩  
Raspatory Hook

★ ZQ2076RN 160xR6x10, 锐 Sharp



换柄式较刀  
Reamer, handle changeable

★ ZQ1947RN 150, 三角刃长20  
Blade length 20



换柄式六角起子  
Hex Screwdriver, handle changeable

★ ZQ2079RN 90xSw1.5    ★ ZQ2082RN 90xSw3.0    ★ ZQ2085RN 90xSw4.5  
★ ZQ2080RN 90xSw2.0    ★ JQ2083RN 90xSw3.5    ★ ZQ2086RN 90xSw5.0  
★ JQ2081RN 90xSw2.5    ★ ZQ2084RN 90xSw4.0    ★ ZQ2087RN 90xSw5.5



换柄式四方起子  
Square Screwdriver, handle changeable

★ JQ2092RN 90xSw1.2  
★ JQ2093RN 90xSw1.5



换柄式一字起子  
Flat Screwdriver, handle changeable

★ ZQ2100RN 90x0.5x3  
★ ZQ2101RN 90x0.6x6



换柄式十字起子  
Cross Screwdriver, handle changeable

★ JQ2108RN 90x0.4x2  
ZQ2109RN 90x0.5



换柄式 U 型上钉器  
Screw Applier, U-shape, handle changeable

★ ZQ1335RN 90xR2.5x11



换柄式断钉拔出 (取出) 器  
Remover of Broken Screws, handle changeable

★ ZQ2115RN 195xH3.5  
★ ZQ2116RN 195xH4.5



换柄式梅花起子  
Torx Screwdriver, handle changeable



- ★ JQ2127RN 90xT8(φ2.3)    ★ JQ2130RN 90xT15(φ3.3)    ★ JQ2132RN 90xT25(φ4.4)
- ★ JQ2129RN 90xT10(φ2.7)    ★ ZQ2131RN 90xT20(φ3.8)    ★ ZQ2134RN 90xT30(φ5.4)
- ZQ2123RN 90X1.5    ZQ2124RN 90X1.7    ZQ2125RN 90X2.0
- ZQ2126RN 90X2.5    ZQ2128RN 90X3.0    ZQ2133RN 90X4.3

硬质合金钻头  
TC Drill



- ★ ZQ2144RN 80xφ5    ★ ZQ2150RN 80xφ7
- ★ ZQ2147RN 80xφ6

螺钉打滑取出器  
Hexagon Sliding Screw Extractor, handle changeable

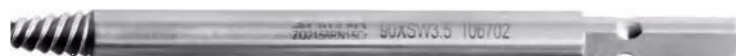

- ★ ZQ2154RN 90xSw2.5    ZQ2157RN 90xSw4.0
- ★ ZQ2156RN 90xSw3.5    ZQ2153RN 90XSw2.7
- ZQ2153RN 90XSw2.0

圆骨刀 (铝合金柄)  
Gouge



- ★ ZQ1240RN 200x8, 直, 圆刃

换柄式空心钻  
Bone Trephine, handle changeable



- ★ ZQ2161RN 90xH2.0(φ2.3)    ★ ZQ2168RN 150xH4.0(φ4.3)    ★ ZQ2174RN 150xH6.5(φ6.8)
- ★ ZQ2164RN 90xH2.7(φ3)    ★ ZQ2171RN 150xH5.0(φ5.3)    ★ ZQ2177RN 150xH8.0(φ8.2)

脊椎环钻  
Vertebral Trephine

- ZF859R 170xφ8
- ZF860R 160xφ15



换柄式取钉环钻  
Screw Trephine, handle changeable



- ★ ZQ2180RN 90x4.0    ★ ZQ2185RN 90x6.5
- ★ ZQ2182RN 90x5.0

直型快换手柄  
Handle, straight



- ★ ZQ2188RN 160

T型快换手柄  
Handle, T-shape

- ★ ZQ2189RN 100





NQD - I 型内固定取(断)钉手术器械(ZQ1400)  
NQD-I nail removal instruments set(ZQ1400)

序号	编码	名称	规格	单位	数量
1	ZQ2076RN	剥离钩	160×R6×10, 锐	支	1
2	ZQ1947RN	换柄式铰刀	150, 三角刃长20	支	1
3	ZQ2079RN	换柄式六角起子	90×Sw1.5	支	1
4	ZQ2080RN	换柄式六角起子	90×Sw2.0	支	1
5	JQ2081RN	换柄式六角起子	90×Sw2.5	支	2
6	ZQ2082RN	换柄式六角起子	90×Sw3.0	支	1
7	JQ2083RN	换柄式六角起子	90×Sw3.5	支	1
8	ZQ2084RN	换柄式六角起子	90×Sw4.0	支	1
9	ZQ2085RN	换柄式六角起子	90×Sw4.5	支	1
10	ZQ2086RN	换柄式六角起子	90×Sw5.0	支	1
11	ZQ2087RN	换柄式六角起子	90×Sw5.5	支	1
12	JQ2092RN	换柄式四方起子	90×Sw1.2	支	1
13	JQ2093RN	换柄式四方起子	90×Sw1.5	支	1
14	ZQ2100RN	换柄式一字起子	90×0.5×3	支	1
15	ZQ2101RN	换柄式一字起子	90×0.6×6	支	1
16	JQ2108RN	换柄式十字起子	90×0.4×2	支	1
17	ZQ1335RN	换柄式U型上钉器	90×R2.5×11	支	1
18	ZQ2115RN	换柄式断钉拔出(取出)器	195×H3.5	把	1
19	ZQ2116RN	换柄式断钉拔出(取出)器	195×H4.5	把	1
20	ZQ2121RN	断钉拔出钳	200, 夹持H3-5	把	1

序号	编码	名称	规格	单位	数量
21	JQ2127RN	换柄式梅花起子	90×T8	支	1
22	JQ2129RN	换柄式梅花起子	90×T10	支	2
23	JQ2130RN	换柄式梅花起子	90×T15	支	1
24	ZQ2131RN	换柄式梅花起子	90×T20	支	1
25	JQ2132RN	换柄式梅花起子	90×T25	支	1
26	ZQ2134RN	换柄式梅花起子	90×T30	支	1
27	ZQ2144RN	硬质合金钻头	80×Φ5	支	1
28	ZQ2147RN	硬质合金钻头	80×Φ6	支	1
29	ZQ2150RN	硬质合金钻头	80×Φ7	支	1
30	ZQ2154RN	螺钉打滑取出器	90×Sw2.5	支	1
31	ZQ2156RN	螺钉打滑取出器	90×Sw3.5	支	1
32	ZQ2157RN	螺钉打滑取出器	90×Sw4.0	支	1
33	ZQ1240RN	圆骨刀(铝合金柄)	200×8, 直, 圆刃	把	1
34	ZQ2161RN	换柄式空心钻	90×H2.0	支	1
35	ZQ2164RN	换柄式空心钻	90×H2.7	支	1
36	ZQ2168RN	换柄式空心钻	150×H4.0	支	1
37	ZQ2171RN	换柄式空心钻	150×H5.0	支	1
38	ZQ2174RN	换柄式空心钻	150×H6.5	支	1
39	ZQ2177RN	换柄式空心钻	150×H8.0	支	1
40	ZQ2180RN	换柄式取钉环钻	90×4.0	支	1
41	ZQ2182RN	换柄式取钉环钻	90×5.0	支	1
42	ZQ2185RN	换柄式取钉环钻	90×6.5	支	1
43	ZQ2188RN	直型快换手柄	160	把	1
44	ZQ2189RN	T型快换手柄	100	把	1



NQD - II 型内固定取(断)钉手术器械(DQ1400)  
NQD- II nail removal instruments set(DQ1400)

序号	产品编码	产品名称	规格型号	数量	单位
1	DQ2081RN	起子	90×Sw2.5, 六角, 换柄式	2	支
2	DQ2083RN	起子	90×Sw3.5, 六角, 换柄式	1	支
3	DQ2092RN	起子	90×Sw1.2, 四方, 换柄式	1	支
4	DQ2093RN	起子	90×Sw1.5, 四方, 换柄式	1	支
5	DQ2108RN	起子	90×0.4×2, 十字, 换柄式	1	支
6	DQ2127RN	起子	90×T8, 梅花, 换柄式	1	支
7	DQ2129RN	起子	90×T10, 梅花, 换柄式	2	支
8	DQ2130RN	起子	90×T15, 梅花, 换柄式	1	支
9	DQ2132RN	起子	90×T25, 梅花, 换柄式	1	支
10	DQ1240RN	骨刀	200×8, 直, 圆刃	1	支
11	DQ1335RN	起子	90×R2.5×11, 换柄式, U型	1	把
12	DQ1947RN	骨铰刀	150, 三角刃, 刃长20, 换柄式	1	支
13	DQ2076RN	剥离器	160×R6×10, 尖头	1	支
14	DQ2079RN	起子	90×Sw1.5, 换柄式, 六角	1	支

序号	产品编码	产品名称	规格型号	数量	单位
15	DQ2080RN	起子	90×Sw2.0, 换柄式, 六角	1	支
16	DQ2082RN	起子	90×Sw3.0, 换柄式, 六角	1	支
17	DQ2084RN	起子	90×Sw4.0, 换柄式, 六角	1	支
18	DQ2085RN	起子	90×Sw4.5, 换柄式, 六角	1	支
19	DQ2086RN	起子	90×Sw5.0, 换柄式, 六角	1	支
20	DQ2087RN	起子	90×Sw5.5, 换柄式, 六角	1	支
21	DQ2100RN	起子	90×0.5×3, 换柄式, 一字	1	支
22	DQ2101RN	起子	90×0.6×6, 换柄式, 一字	1	支
23	DQ2115RN	断钉取出器	195×H3.5, 换柄式	1	把
24	DQ2116RN	断钉取出器	195×H4.5, 换柄式	1	把
25	DQ2121RN	断钉取出器	200, 夹持H3-5	1	支
26	DQ2131RN	起子	90×T20, 换柄式, 梅花	1	支
27	DQ2134RN	起子	90×T30, 换柄式, 梅花	1	支
28	DQ2144RN	骨科钻头	65×Φ5, 硬质合金	1	支
29	DQ2147RN	骨科钻头	65×Φ6, 硬质合金	1	支
30	DQ2150RN	骨科钻头	65×Φ7, 硬质合金	1	支
31	DQ2154RN	螺钉打滑取出器	90×Sw2.5, 换柄式, 六角	1	支
32	DQ2156RN	螺钉打滑取出器	90×Sw3.5, 换柄式, 六角	1	支
33	DQ2157RN	螺钉打滑取出器	90×Sw4.0, 换柄式, 六角	1	把
34	DQ2161RN	取钉器	90×H2.0, 换柄式	1	支
35	DQ2164RN	取钉器	90×H2.7, 换柄式	1	支
36	DQ2168RN	取钉器	150×H4.0, 换柄式	1	支
37	DQ2171RN	取钉器	150×H5.0, 换柄式	1	支
38	DQ2174RN	取钉器	150×H6.5, 换柄式	1	支
39	DQ2177RN	取钉器	150×H8.0, 换柄式	1	支
40	DQ2180RN	取钉器	90×4.0, 换柄式	1	支
41	DQ2182RN	取钉器	90×5.0, 换柄式	1	支
42	DQ2185RN	取钉器	90×6.5, 换柄式	1	把
43	DQ2188RN	快装手柄	140, 直型	1	把
44	DQ2189RN	快装手柄	100, T型	1	把

取钉器  
Nail extractor



- |                     |                                 |                                  |
|---------------------|---------------------------------|----------------------------------|
| ZQ4207RN 90×M4      | ZQ4219RN 90×M7                  | ZQ4210RN 90×M7, 左旋 left rotation |
| ZQ4208RN 90×M5      | ZQ4214RN 90×M11                 | ZQ4211RN 90×M8, 细牙 fine thread   |
| ZQ4209RN 90×M6      | ZQ4215RN 90×M12, 细牙 fine thread | ZQ4212RN 90×M9                   |
| ZQ4217RN 90×M12     | ZQ4216RN 90×M10                 | ZQ4213RN 90×M10, 细牙 fine thread  |
| ZQ4218RN 90×7\16-20 |                                 |                                  |

取钉器  
Nail extractor



- ZQ4204RN 90×φ3.8, 锥度  
ZQ4205RN 90×φ5.3, 锥度  
ZQ4206RN 90×φ9.5, 锥度

起子  
Square screwdriver



- ZQ4241RN 300, PFNA刀片, 左旋 for PFNA nail, left rotation  
ZQ4242RN 300, PFNA刀片 for PFNA nail

起子  
Hex screwdriver



- |                             |                             |
|-----------------------------|-----------------------------|
| ZQ4227RN 150×SW2.5, 换柄式, 六角 | ZQ4231RN 150×SW4.5, 换柄式, 六角 |
| ZQ4228RN 150×SW3.0, 换柄式, 六角 | ZQ4232RN 150×SW5.0, 换柄式, 六角 |
| ZQ4229RN 150×SW3.5, 换柄式, 六角 | ZQ4233RN 150×SW7.0, 换柄式, 六角 |
| ZQ4230RN 150×SW4.0, 换柄式, 六角 | ZQ4234RN 150×SW8.0, 换柄式, 六角 |

起子  
Flat screwdriver



- ZQ4220RN 150×1×6, 换柄式, 一字

起子  
Torx screwdriver



- ZQ4221RN 150×T25, 换柄式, 梅花  
ZQ4222RN 150×T20, 换柄式, 梅花  
ZQ4223RN 150×T18, 换柄式, 梅花

骨刀  
Gouge, aluminum handle



- ZQ4245RN 200×6, 直, 圆刃, 铝合金柄

打拔器  
Extractor



- ZQ4237RN 350

骨锤  
Bone mallet



- ZQ4236RN 260

断钉取出器  
Broken nail extractor



- ZQ4243RN 250, 夹持H8-10  
for H8-10

骨科钻头  
TC twist drill

ZQ4246RN 80×Φ4, 硬质合金  
ZQ2144RN 80×Φ5, 硬质合金  
ZQ2147RN 80×Φ6, 硬质合金



快装手柄  
Quick coupling handle

ZQ2189RN 100, T型



扳手  
Wrench

ZQ4202RN 150×Φ4.3



扳手  
Wrench

ZQ4203RN 130, 双头



螺钉打滑取出器  
Damaged srew extractor

ZQ4240RN 400×Sw3.0, T型



螺钉打滑取出器  
Damaged srew extractor

ZQ4224RN 150×Sw2.5, 换柄式, 六角  
ZQ4225RN 150×Sw3.5, 换柄式, 六角  
ZQ4226RN 150×Sw4.0, 换柄式, 六角



起子  
Screw river

ZQ4239RN SW5.0, 万向 universal



打拔器  
Extractor

ZQ4238RN 140



取钉器  
Nail extractor

ZQ4235RN 150, 换柄式



骨锤  
Bone mallet

ZQ4244RN 100



扳手  
Wrench

ZQ4201RN 155, 双头, SW5.0 double ended





NQD- II 内固定取出手术器械包(ZQ4200)  
NQD-II intramedullary nail removal instruments set(ZQ4200)

序号	产品编码	产品名称	规格型号	数量	单位
1	ZQ4207RN	取钉器	90×M4	1	支
2	ZQ4208RN	取钉器	90×M5	1	支
3	ZQ4209RN	取钉器	90×M6	1	支
4	ZQ4210RN	取钉器	90×M7,左旋	1	支
5	ZQ4211RN	取钉器	90×M8,细牙	1	支
6	ZQ4212RN	取钉器	90×M9	1	支
7	ZQ4213RN	取钉器	90×M10,细牙	1	支
8	ZQ4214RN	取钉器	90×M11	1	支
9	ZQ4204RN	取钉器	90×φ3.8,锥度	1	支
10	ZQ4205RN	取钉器	90×φ5.3,锥度	1	支
11	ZQ4206RN	取钉器	90×φ9.5,锥度	1	支
12	ZQ4215RN	取钉器	90×M12,细牙	1	支
13	ZQ4216RN	取钉器	90×M10	1	支
14	ZQ4217RN	取钉器	90×M12	1	支
15	ZQ4218RN	取钉器	90×7\16-20	1	支
16	ZQ4219RN	取钉器	90×M7	1	支
17	ZQ4241RN	起子	300, PFNA刀片,左旋	1	把
18	ZQ4242RN	起子	300, PFNA刀片	1	把
19	ZQ4227RN	起子	150×SW2.5,换柄式,六角	1	支
20	ZQ4228RN	起子	150×SW3.0,换柄式,六角	1	支

序号	产品编码	产品名称	规格型号	数量	单位
21	ZQ4229RN	起子	150×SW3.5,换柄式,六角	1	支
22	ZQ4230RN	起子	150×SW4.0,换柄式,六角	1	支
23	ZQ4231RN	起子	150×SW4.5,换柄式,六角	1	支
24	ZQ4232RN	起子	150×SW5.0,换柄式,六角	1	支
25	ZQ4233RN	起子	150×SW7.0,换柄式,六角	1	支
26	ZQ4234RN	起子	150×SW8.0,换柄式,六角	1	支
27	ZQ4220RN	起子	150×1×6,换柄式,一字	1	支
28	ZQ4221RN	起子	150×T25,换柄式,梅花	1	支
29	ZQ4222RN	起子	150×T20,换柄式,梅花	1	支
30	ZQ4223RN	起子	150×T18,换柄式,梅花	1	支
31	ZQ4245RN	骨刀	200×6,直,圆刃,铝合金柄	1	把
32	ZQ4237RN	打拔器	350	1	把
33	ZQ4236RN	骨锤	260	1	把
34	ZQ4243RN	断钉取出器	250,夹持H8-10	1	把
35	ZQ4246RN	骨科钻头	80×φ4,硬质合金	1	支
36	ZQ2144RN	骨科钻头	80×φ5,硬质合金	1	支
37	ZQ2147RN	骨科钻头	80×φ6,硬质合金	1	支
38	ZQ2189RN	快装手柄	100,T型	1	把
39	ZQ4202RN	扳手	150×φ4.3	1	把
40	ZQ4203RN	扳手	130,双头	1	把
41	ZQ4240RN	螺钉打滑取出器	400×Sw3.0,T型	1	支
42	ZQ4224RN	螺钉打滑取出器	150×Sw2.5,换柄式,六角	1	支
43	ZQ4225RN	螺钉打滑取出器	150×Sw3.5,换柄式,六角	1	支
44	ZQ4226RN	螺钉打滑取出器	150×Sw4.0,换柄式,六角	1	支
45	ZQ4239RN	起子	SW5.0,万向	1	把
46	ZQ4238RN	打拔器	140	1	把
47	ZQ4235RN	取钉器	150,换柄式	1	支

NQD-III 内固定取出手术器械包(ZQ4250)  
NQD-III intramedullary nail removal instruments set(ZQ4250)

序号	产品编码	产品名称	规格型号	数量	单位
1	ZQ4207RN	取钉器	90×M4	1	支
2	ZQ4208RN	取钉器	90×M5	1	支
3	ZQ4209RN	取钉器	90×M6	1	支
4	ZQ4210RN	取钉器	90×M7,左旋	1	支
5	ZQ4211RN	取钉器	90×M8,细牙	1	支
6	ZQ4212RN	取钉器	90×M9	1	支
7	ZQ4213RN	取钉器	90×M10,细牙	1	支
8	ZQ4214RN	取钉器	90×M11	1	支
9	ZQ4204RN	取钉器	90×φ3.8,锥度	1	支
10	ZQ4205RN	取钉器	90×φ5.3,锥度	1	支
11	ZQ4206RN	取钉器	90×φ9.5,锥度	1	支
12	ZQ4215RN	取钉器	90×M12,细牙	1	支
13	ZQ4216RN	取钉器	90×M10	1	支
14	ZQ4217RN	取钉器	90×M12	1	支
15	ZQ4218RN	取钉器	90×7\16-20	1	支
16	ZQ4219RN	取钉器	90×M7	1	支
17	ZQ4241RN	起子	300,PFNA刀片,左旋	1	把
18	ZQ4242RN	起子	300,PFNA刀片	1	把
19	ZQ4227RN	起子	150×SW2.5,换柄式,六角	1	支
20	ZQ4228RN	起子	150×SW3.0,换柄式,六角	1	支
21	ZQ4229RN	起子	150×SW3.5,换柄式,六角	1	支
22	ZQ4230RN	起子	150×SW4.0,换柄式,六角	1	支
23	ZQ4231RN	起子	150×SW4.5,换柄式,六角	1	支
24	ZQ4232RN	起子	150×SW5.0,换柄式,六角	1	支
25	ZQ4233RN	起子	150×SW7.0,换柄式,六角	1	支
26	ZQ4234RN	起子	150×SW8.0,换柄式,六角	1	支
27	ZQ4237RN	打拔器	350	1	把
28	ZQ2189RN	快装手柄	100,T型	1	把
29	ZQ4202RN	扳手	150×φ4.3	1	把
30	ZQ4203RN	扳手	130,双头	1	把
31	ZQ4238RN	打拔器	140	1	把
32	ZQ4235RN	取钉器	150,换柄式	1	支
33	ZQ4244RN	骨锤	100	1	把
34	ZQ4201RN	扳手	155,双头,SW5.0	1	把